

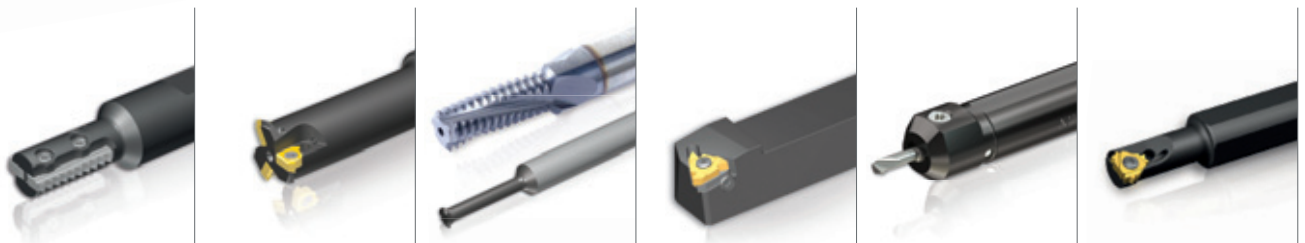

# VARDEX

Advanced Threading Solutions



Turning and Milling Tools

Threading | Grooving | Boring

Main Catalogue

METRIC

# NEW IN THIS CATALOGUE

## NEW SOLID CARBIDE TOOLS

### HELICOOL FAMILY

▶ **Helicool**  
Helical Flutes with Thru-Hole Coolant



▶ **Helicool-R (HCR)**  
Radial Coolant



▶ **Helicool-C (HCC)**  
Thread & Chamfer in One Tool



▶ **Thriller (HTC)**  
Drill, Thread & Chamfer in One Tool

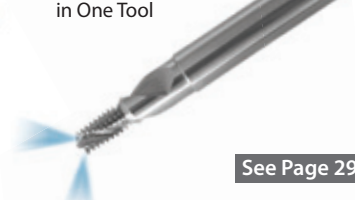

See Page 292

### MILLIPRO FAMILY

▶ Miniature Thread Mills



See Page 305

### DEEP THREADING

▶ Long Reaching up to 3xD<sub>o</sub>



See Page 304

### HELICAL

▶ Economical Tool for Thru-Holes

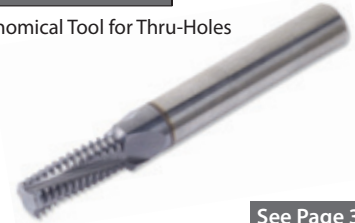

See Page 300

## MULTI+ INSERTS

▶ Improved Design for Multi-Tooth Inserts

See Pages 17-95

**Multi+**  
plus



M+



T+



Z+

## MINI-3 IC4.0

▶ Indexable Threading Insert for Small Bores



See Pages 17-95

## V6 INSERTS

▶ A Revolutionary 6 Cutting Corners System

See Pages 17-95

**V6**



## TMSD

▶ Thread Mills for Deep Holes



See Page 273

## MICROSCOPE

▶ New Advanced Clamping System for Micro Single Ended Tools



See Page 17-123

**microscope**

## MiTM FAMILY

▶ Multi-Flute Indexable Thread Milling for Fast Machining

See Page 253

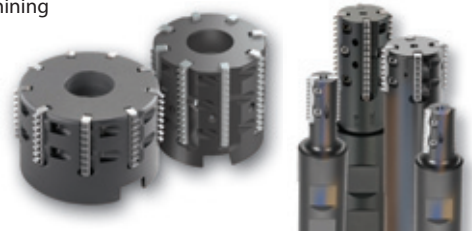

# VARDEX CATALOGUE

## VARDEX TURNING

## CHAPTER

■ Thread Turning	6-146
■ Grooving	147-170
■ Boring	171-192

## VARDEX MILLING

■ Thread Milling Standard	193-252
■ MiTM - Multi-Flute Indexable Thread Mill Inserts	253-272
■ TMSD - Thread Milling for Deep Holes	273-288
■ TM Solid - Solid Carbide Thread Milling	289-320
■ Groove Milling	321-328

Visit our website at [www.vargus.com](http://www.vargus.com)



## NUMBER ONE IN THREADING

VARGUS is a world leading developer, manufacturer and supplier of high-quality, precision cutting and deburring tools. The company's VARDEX product line is the number one source for threading solutions worldwide and includes the largest range of thread turning and thread milling solutions as well as an extensive range of solutions for micro-machining.

Established in 1960, VARGUS is a member of the NEUMO Ehrenberg Group, a diversified multi-national organization headquartered in Knittlingen, Germany. With a network of international distributors, warehouses and certified ISO 9001 manufacturing facilities, VARGUS serves customers in more than 100 countries around the globe, providing fast delivery and dedicated customer service.

Vargus is a customer-focused organization, committed to providing innovative products of the highest quality, excellent value, top service and technical expertise.

These key values have helped Vargus remain the market leader in threading solutions and will continue to guide our approach to business in the future.



# VARDEX SPECIAL TOOLS

VARDEX engineers and toolmakers have the know-how and experience to design special cutting tools tailored to customer requirements. Whether it's a special, complex shape or a non-standard size, our Special Tools service can quickly produce the tool you need using the latest techniques and technology.

For specific details, contact your nearest VARDEX sales representative.

- VARDEX expertise
- Fast quotation
- Competitive delivery

**Tailor Made**

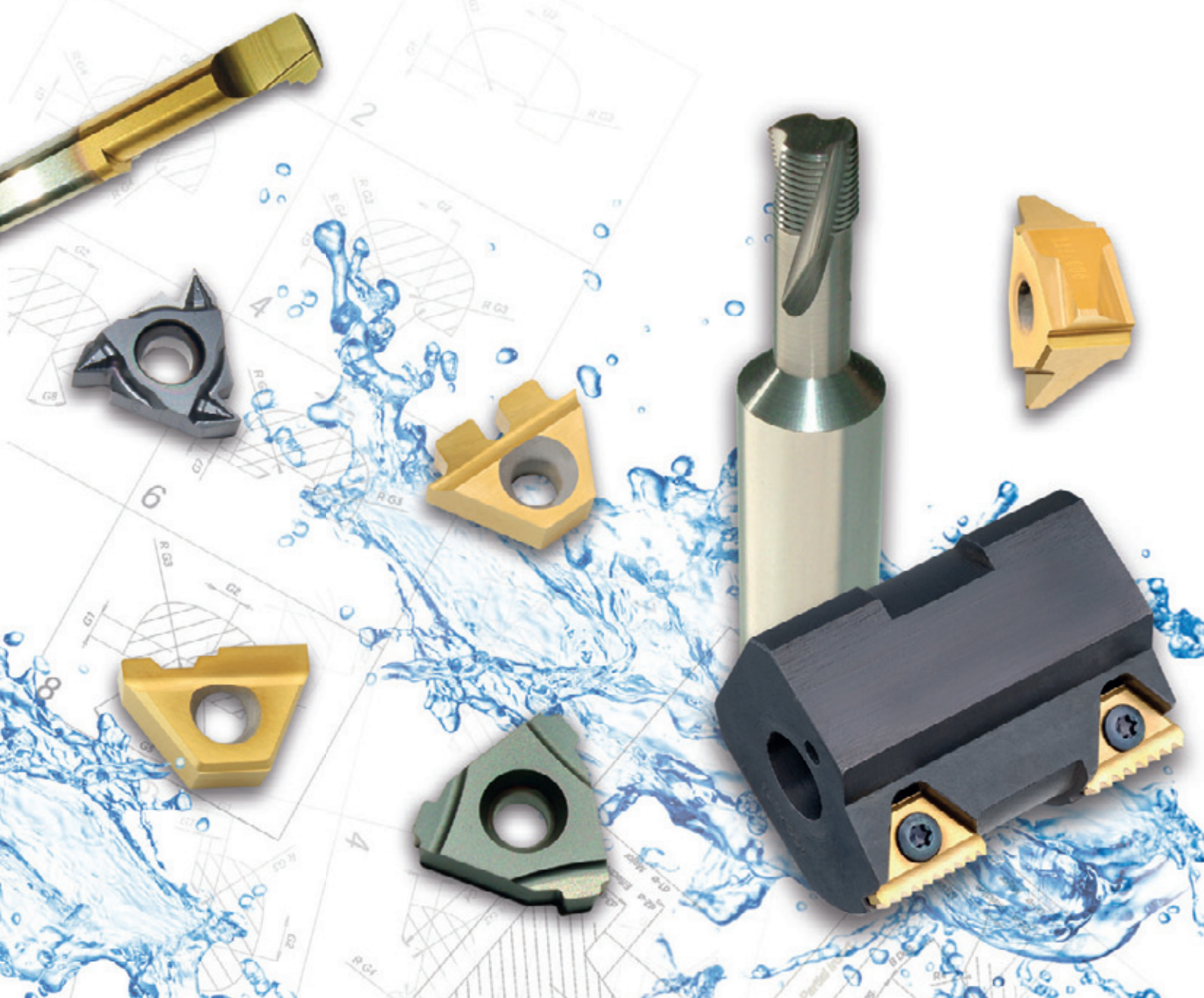

# TURNING

■ Thread Turning System - External.....	Page 6
■ Tooling Recommendation.....	Page 8

## Threading

■ Threading Inserts.....	Page 17
■ Threading Toolholders.....	Page 97
■ Threading Technical Data.....	Page 125

## Grooving

■ Grooving Inserts.....	Page 147
■ Grooving Toolholders.....	Page 163
■ Grooving Technical Data.....	Page 169

## Boring

■ Boring Inserts.....	Page 171
■ Boring Toolholders.....	Page 181
■ Boring Technical Data.....	Page 189

## TT Gen: Takes the guesswork out of threading!

### TT Gen

#### Thread Turning Tool Selection Software

VARGUS' TT Gen software guides you to the right thread turning tool and the best cutting conditions for your applications in seconds.

The latest version can be downloaded at [www.vargus.com](http://www.vargus.com)



# Turning



- > Threading
- > Grooving
- > Boring

# Thread Turning System - External

## Standard

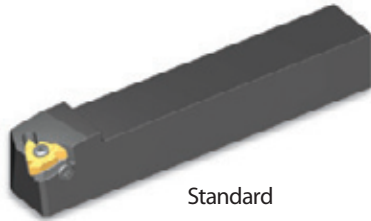

Standard



Standard With Clamp

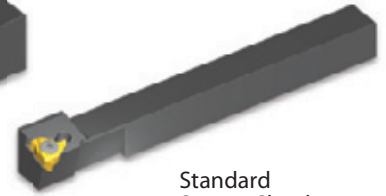

Standard Square Shank



6°

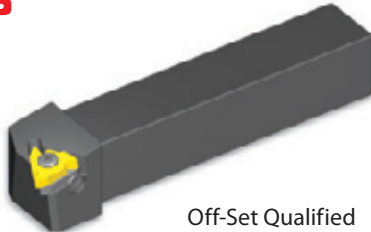

Off-Set Qualified

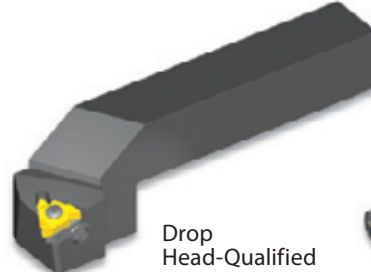

Drop Head-Qualified



Miniature Round Shank



SCB

## U Style



U Style



U Style with Clamp

## V Style

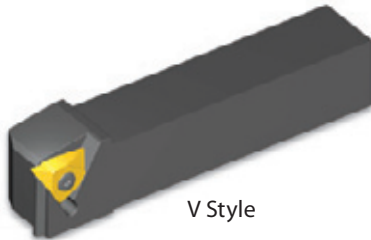

V Style

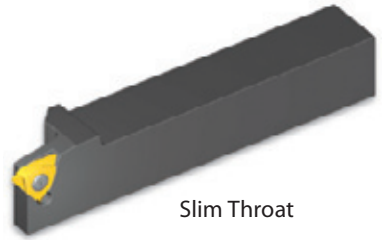

Slim Throat

## M+ Style



M+ Style

## Z+ Style



Z+ Style

## T+ Style



T+ Style



# Thread Turning System - Internal

## Standard

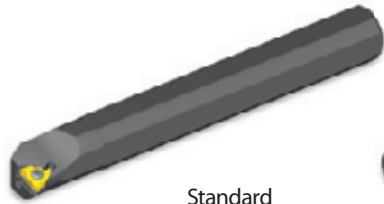

Standard

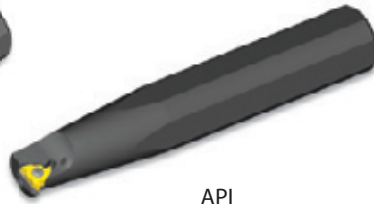

API



Miniature Square Shank

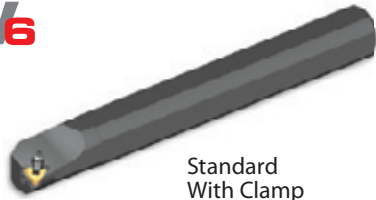

Standard With Clamp



Carbide Shank



Miniature Round Shank

## U Style

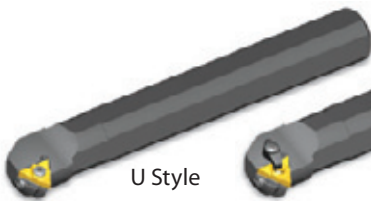

U Style

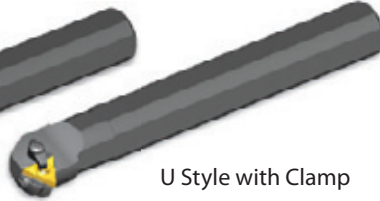

U Style with Clamp

## V Style

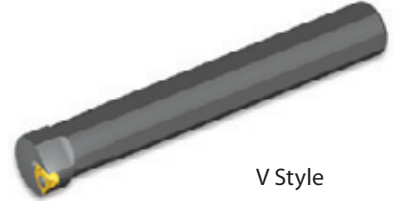

V Style

## M+ Style



M+ Style

## T+ Style



T+ Style

## Z+ Style



Z+ Style

## Mini-3

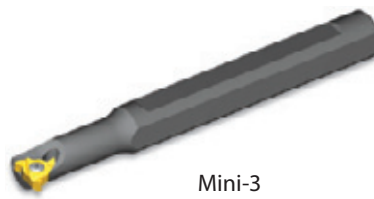

Mini-3



Mini-3 Adjustable

## Mini-L

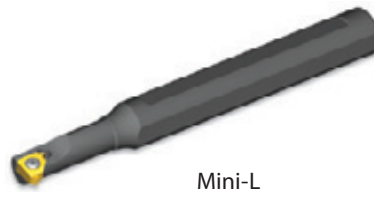

Mini-L



Mini-L Adjustable

## Micro



## microscope



Micro Single-Ended



Micro Double-Ended

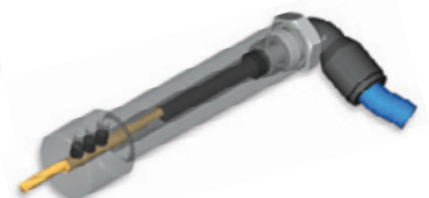

# Tooling recommendation for a given Internal thread specification

TT Gen Software  
and updated versions  
can be downloaded from  
[www.vargus.com](http://www.vargus.com)



## ISO Metric

Pitch mm	Thread	Insert Size	Ordering Code		
			Insert	Holder	Anvil
0.70	4	Micro 3.0	3.0SIR0.7ISO	SMC..-3	-
	6	Micro 4.0	4.0SIR0.75ISO	SMC..-4	-
0.75	8	Micro 6.0	6.0SIR0.75ISO	SMC..-6	-
	10	IC 5.0 L	5LIR0.75ISO	.NVR10.-5L	-
0.80	5	Micro 3.0	3.0SIR0.8ISO	SMC..-3	-
	M6	Micro 4.0	4.0SIR1.0ISO	SMC..-4	-
	8	Micro 6.0	6.0SIR1.0ISO	SMC..-6	-
1.00	10	IC 5.0 L	5LIR1.0ISO	.NVR10.-5L	-
	12-14	IC 6.0	6.0IR1.0ISO	.NVR1..-6.0	-
	15-17	IC 1/4"	2IR1.0ISO	NVR10-2	-
	18	IC 1/4"	2IR1.0ISO	NVR13-2	-
	20-24	IC 3/8"	3IR1.0ISO	NVR13-3	-
	M8	Micro 6.0	6.0SIR1.25ISO	SMC..-6.0	-
1.25	10	IC 5.0 L	5LIR1.25ISO	.NVR10.-5L	-
	12-14	IC 6.0	6.0IR1.25ISO	.NVR1..-6.0	-
	M10	IC 5.0 L	5LIR1.5ISO	.NVR10.-5L	-
1.50	12-14	IC 6.0	6.0IR1.5ISO	.NVR1..-6.0	-
	15-18	IC 1/4"	2IR1.5ISO	NVR10-2	-
	20-25	IC 3/8"	3IR1.5ISO	NVR13-3	-
	26-28	IC 3/8"	3IR1.5ISO	AVR20-3	Y13
	30-36	IC 3/8"	3IR1.5ISO	AVR20-3	Y13-1N
	38-45	IC 3/8"	3IR1.5ISO	AVR32-3	Y13-1N
	48-68	IC 3/8"	3IR1.5ISO	AVR40-3	Y13-1N
1.75	M12	IC 6.0	6.0IR1.75ISO	.NVR1..-6.0	-
	M14	IC 6.0	6.0IR2.0ISO	.NVR1..-6.0	-
	M16-18	IC 1/4"	2IR2.0ISO	NVR10-2	-
	20-22	IC 3/8"	3IR2.0ISO	NVR13-3	-
2.00	24	IC 3/8"	3IR2.0ISO	NVR16-3	-
	27-30	IC 3/8"	3IR2.0ISO	AVR20-3	Y13
	33-36	IC 3/8"	3IR2.0ISO	AVR25-3	Y13
	39-45	IC 3/8"	3IR2.0ISO	AVR32-3	Y13-1N
	48-68	IC 3/8"	3IR2.0ISO	AVR40-3	Y13-1N
	M18	IC 1/4"	2IR2.5ISO	NVR10-2	-
2.50	M20-M22	IC 3/8"	3IR2.5ISO	NVR13-3	-
	M24-M27	IC 3/8"	3IR3.0ISO	NVR16-3	-
3.00	36-45	IC 3/8"	3IR3.0ISO	AVR25-3	Y13
	48-68	IC 3/8"	3IR3.0ISO	AVR40-3	Y13
3.50	M30-M33	IC 3/8"	3IR3.5ISO	NVR16-3	-
	M36	IC 1/2"	4IR4.0ISO	NVR20-4	-
4.00	M39	IC 1/2"	4IR4.0ISO	AVR25-4	Y14
	56-68	IC 1/2"	4IR4.0ISO	AVR40-4	Y14
4.50	M42	IC 1/2"	4IR4.5ISO	AVR25-4	Y14-1P
	M45	IC 1/2"	4IR4.5ISO	AVR32-4	Y14
5.00	M48	IC 1/2"	4IR5.0ISO	AVR32-4	Y14-1P
	M52	IC 1/2"	4IR5.0ISO	AVR32-4	Y14
5.50	M56-60	IC 5/8"	5IR5.5ISO	AVR40-5	Y15
6.00	M64-68	IC 5/8"	5IR6.0ISO	AVR40-5	Y15

# Tooling recommendation for a given Internal thread specification

TT Gen Software  
and updated versions  
can be downloaded from  
[www.vargus.com](http://www.vargus.com)



## American UN

Pitch tpi	Thread	Insert Size	Ordering Code		
			Insert	Holder	Anvil
56	10 - 1/4	Micro 4.0	Special	SMC..-4.0	-
48	10 - 5/16	Micro 4.0	Special	SMC..-4.0	-
40	10 - 3/8	Micro 4.0	4.0SIR40UN	SMC..-4.0	-
36	12 - 3/8	Micro 4.0	4.0SIR36UN	SMC..-4.0	-
32	12 - 1/4	Micro 4.0	4.0SIR32UN	SMC..-4.0	-
	5/16 - 3/8	Micro 6.0	6.0SIR32UN	SMC..-6.0	-
	7/16 - 1/2	IC 6.0	6.0IR32UN	.NVR 1..-6.0	-
	9/16 - 11/16	IC 1/4"	2IR32UN	NVR10-2	-
	3/4 - 15/16	IC 3/8"	3IR32UN	NVR13-3	-
	7/8 - 15/16	IC 3/8"	3IR32UN	NVR16-3	-
	1	IC 3/8"	3IR32UN	AVR20-3	Y13 - 1N
28	12 - 1/4	Micro 4.0	4.0SIR28UN	SMC..-4.0	-
	5/16 - 3/8	Micro 6.0	6.0SIR28UN	SMC..-6.0	-
	7/16 - 1/2	IC 6.0	6.0IR28UN	.NVR 1..-6.0	-
	5/8 - 11/16	IC 1/4"	2IR28UN	NVR10-2	-
	3/4 - 13/16	IC 3/8"	3IR28UN	NVR13-3	-
	7/8 - 15/16	IC 3/8"	3IR28UN	NVR16-3	-
	1 - 1 1/8	IC 3/8"	3IR28UN	AVR20-3	Y13 - 1N
1 3/16	IC 3/8"	3IR28UN	AVR25-3	Y13 - 1N	
27	1/4	Micro 4.0	4.0SIR27UN	SMC..-4.0	-
	5/16 - 3/8	Micro 6.0	6.0SIR27UN	SMC..-6.0	-
	7/16 - 1/2	IC 6.0	Special	.NVR 1..-6.0	-
	9/16 - 5/8	IC 1/4"	2IR27UN	NVR10-2	-
	3/4	IC 3/8"	3IR27UN	NVR13-3	-
	7/8	IC 3/8"	3IR27UN	NVR16-3	-
1	IC 3/8"	3IR27UN	AVR20-3	Y13 - 1N	
24	12 - 1/4	Micro 4.0	4.0SIR24UN	SMC..-4.0	-
	5/16 - 3/8	Micro 6.0	6.0SIR24UN	SMC..-6.0	-
	7/16	IC 5.0 L	5LIR24UN	.NVR10.-5L	-
	1/2	IC 6.0	6.0IR24UN	.NVR 1..-6.0	-
	9/16 - 11/16	IC 1/4"	2IR24UN	NVR10-2	-
	3/4	IC 3/8"	3IR24UN	NVR13-3	-
	7/8	IC 3/8"	3IR24UN	NVR16-3	-
	1 - 1 1/8	IC 3/8"	3IR24UN	AVR20-3	Y13 - 1N
	1 1/4 - 1 1/2	IC 3/8"	3IR24UN	AVR25-3	Y13 - 1N
1 5/8 - 24	IC 3/8"	3IR24UN	AVR32-3	Y13 - 1N	
20	5/16 - 3/8	Micro 6.0	6.0SIR20UN	SMC..-6.0	-
	7/16	IC 5.0 L	5LIR20UN	.NVR10.-5L	-
	1/2 - 9/16	IC 6.0	6.0IR20UN	.NVR 1..-6.0	-
	5/8 - 11/16	IC 1/4"	2IR20UN	NVR10-2	-
	3/4 - 13/16	IC 3/8"	3IR20UN	NVR13-3	-
	7/8 - 15/16	IC 3/8"	3IR20UN	NVR16-3	-
	1 - 1 3/16	IC 3/8"	3IR20UN	AVR20-3	Y13 - 1N
	1 1/4 - 1 1/2	IC 3/8"	3IR20UN	AVR25-3	Y13 - 1N
	1 9/16 - 1 13/16	IC 3/8"	3IR20UN	AVR32-3	Y13 - 1N
1 7/8 - 2 1/8	IC 3/8"	3IR20UN	AVR40-3	Y13 - 1N	

# Tooling recommendation for a given Internal thread specification

TT Gen Software  
and updated versions  
can be downloaded from  
[www.vargus.com](http://www.vargus.com)



## American UN (con't)

Pitch tpi	Thread	Insert Size	Ordering Code		
			Insert	Holder	Anvil
18	5/16 - 3/8	Micro 6.0	6.0SIR18UN	SMC..-6.0	-
	7/16	IC 5.0 L	5LIR18UN	.NVR10.-5L	-
	1/2 - 9/16	IC 6.0	6.0IR18UN	.NVR 1..-6.0	-
	5/8	IC 1/4"	2IR18UN	NVR10-2	-
	3/4	IC 3/8"	3IR18UN	NVR13-3	-
	7/8 - 1	IC 3/8"	3IR18UN	NVR16-3	-
	1 1/16 - 1 3/16	IC 3/8"	3IR18UN	AVR20-3	Y13 - 1N
	1 1/4 - 1 1/2	IC 3/8"	3IR18UN	AVR25-3	Y13 - 1N
	1 9/16 - 1 3/4	IC 3/8"	3IR18UN	AVR32-3	Y13 - 1N
16	1 7/8 - 2	IC 3/8"	3IR18UN	AVR40-3	Y13 - 1N
	3/8	Micro 6.0	6.0SIR16UN	SMC..-6.0	-
	7/16	IC 5.0 L	5LIR16UN	.NVR10.-5L	-
	1/2 - 9/16	IC 6.0	6.0IR16UN	.NVR 1..-6.0	-
	5/8 - 11/16	IC 1/4"	2IR16UN	NVR10-2	-
	3/4 - 13/16	IC 3/8"	3IR16UN	NVR13-3	-
	7/8 - 1	IC 3/8"	3IR16UN	NVR16-3	-
	1 1/16 - 1 1/8	IC 3/8"	3IR16UN	AVR20-3	Y13
	1 3/16	IC 3/8"	3IR16UN	AVR20-3	Y13 - 1N
14	1 1/4 - 1 1/2	IC 3/8"	3IR16UN	AVR25-3	Y13 - 1N
	1 9/16 - 1 13/16	IC 3/8"	3IR16UN	AVR32-3	Y13 - 1N
	1 7/8 - 2 1/8	IC 3/8"	3IR16UN	AVR40-3	Y13 - 1N
	7/16	IC 5.0 L	5LIR14UN	.NVR10.-5L	-
	1/2 - 9/16	IC 6.0	6.0IR14UN	.NVR 1..-6.0	-
	5/8	IC 1/4"	2IR14UN	NVR10-2	-
	3/4	IC 3/8"	3IR14UN	NVR13-3	-
	7/8 - 1	IC 3/8"	3IR14UN	NVR16-3	-
	1 1/8	IC 3/8"	3IR14UN	AVR20-3	Y13
12	1 1/4	IC 3/8"	3IR14UN	AVR25-3	Y13
	1 3/8 - 1 1/2	IC 3/8"	3IR14UN	AVR25-3	Y13 - 1N
	1 5/8 - 1 3/4	IC 3/8"	3IR14UN	AVR32-3	Y13 - 1N
	1 7/8 - 2	IC 3/8"	3IR14UN	AVR40-3	Y13 - 1N
	1/2 - 13	IC 6.0	6.0I13UN...158/001	BNVR 10S-6.0	-
	9/16 - 11/16	IC 1/4"	2I12UN...158/002	NVRC10-2 156/001	-
	3/4 - 7/8	IC 3/8"	3IR12UN	NVR13-3	-
	15/16 - 1	IC 3/8"	3IR12UN	NVR16-3	-
	1 1/16 - 1 3/16	IC 3/8"	3IR12UN	AVR20-3	Y13
10	1 1/4 - 1 1/2	IC 3/8"	3IR12UN	AVR25-3	Y13
	1 9/16 - 1 13/16	IC 3/8"	3IR12UN	AVR32-3	Y13
	1 7/8 - 2 1/8	IC 3/8"	3IR12UN	AVR40-3	Y13 - 1N
	5/8 - 11	IC 1/4U"	2UIR11UN...158/003	NVRC11-2U 156/002	-
	7/8	IC 3/8"	3IR10UN	NVR13-3	-
	1 - 10	IC 3/8"	3IR10UN	NVR16-3	-
	1 1/8 - 10	IC 3/8"	3IR10UN	AVR20-3	Y13
	1 1/4 - 1 1/2	IC 3/8"	3IR10UN	AVR25-3	Y13
	1 5/8 - 1 3/4	IC 3/8"	3IR10UN	AVR32-3	Y13
1 7/8 - 2	IC 3/8"	3IR10UN	AVR40-3	Y13	

## Tooling recommendation for a given Internal thread specification

TT Gen Software  
and updated versions  
can be downloaded from  
[www.vargus.com](http://www.vargus.com)



### American UN (con't)

Pitch tpi	Thread	Insert Size	Ordering Code		
			Insert	Holder	Anvil
9	7/8 - 9	IC 3/8"	3IR9UN	NVR13-3	-
	1	IC 3/8"	3IR8UN	NVR16-3	-
8	1 1/16 - 1 3/16	IC 3/8"	3IR8UN	AVR20-3	Y13 - 1P
	1 1/4	IC 3/8"	3IR8UN	AVR20-3	Y13
	1 5/16 - 1 1/2	IC 3/8"	3IR8UN	AVR25-3	Y13
	1 9/16 - 1 13/16	IC 3/8"	3IR8UN	AVR32-3	Y13
	1 7/8 - 2 1/8	IC 3/8"	3IR8UN	AVR40-3	Y13
7	1 1/8 - 1 1/4	IC 1/2"	4IR7UN	NVR20-4	-
	1 3/8 - 1 7/16	IC 1/2"	4IR6UN	NVR20-4	-
	1 1/2 - 1 5/8	IC 1/2"	4IR6UN	AVR25-4	Y14 - 1P
6	1 11/16	IC 1/2"	4IR6UN	AVR25-4	Y14
	1 3/4 - 2	IC 1/2"	4IR6UN	AVR32-4	Y14
	2 1/8 - 6	IC 1/2"	4IR6UN	AVR40-4	Y14
	1 3/4 - 5	IC 1/2"	4IR5UN	AVR25-4	Y14 - 1P
4.5	2 - 4 1/2	IC 5/8"	5IR4.5UN	AVR32-5	Y15 - 1P

# Tooling recommendation for a given Internal thread specification

TT Gen Software  
and updated versions  
can be downloaded from  
[www.vargus.com](http://www.vargus.com)



## Whitworth

Pitch tpi	Thread	Insert Size	Ordering Code		
			Insert	Holder	Anvil
26	1/4	Micro 4.0	4.0SIR26W	SMC..-4.0	-
	5/16 - 1/2	Micro 6.0	6.0SIR26W	SMC..-6.0	-
	9/16 - 5/8	IC 1/4"	2IR26W	NVR10-2	-
	11/16	IC 1/4"	2IR26W	NVR13-2	-
	3/4 - 13/16	IC 3/8"	3IR26W	NVR13-3	-
	7/8 - 15/16	IC 3/8"	3IR26W	NVR16-3	-
	1 - 1 3/16	IC 3/8"	3IR26W	AVR20-3	YI3 - 1N
	1 1/4 - 1 7/16	IC 3/8"	3IR26W	AVR25-3	YI3 - 1N
	1 1/2 - 1 3/4	IC 3/8"	3IR26W	AVR32-3	YI3 - 1N
22	1 7/8 - 2	IC 3/8"	3IR26W	AVR40-3	YI3 - 1N
	5/16	Micro 6.0	6.0SIR22W	SMC..-6.0	-
	3/8 - 9/16	Micro 6.0	6.0SIR20W	SMC..-6.0	-
	5/8 - 11/16	IC 1/4"	2IR20W	NVR10-2	-
	3/4 - 13/16	IC 3/8"	3IR20W	NVR13-3	-
	7/8 - 1	IC 3/8"	3IR20W	NVR16-3	-
	1 1/16 - 1 3/16	IC 3/8"	3IR20W	AVR20-3	YI3 - 1N
	1 1/4 - 1 7/16	IC 3/8"	3IR20W	AVR25-3	YI3 - 1N
	1 1/2 - 1 3/4	IC 3/8"	3IR20W	AVR32-3	YI3 - 1N
20	1 7/8 - 3	IC 3/8"	3IR20W	AVR40-3	YI3 - 1N
	11/16	IC 1/4"	2IR16W	NVR10-2	-
	3/4 - 11/16	IC 3/8"	3IR16W	NVR13-3	-
	7/8 - 1	IC 3/8"	3IR16W	NVR16-3	-
	1 1/16 - 1 1/8	IC 3/8"	3IR16W	AVR20-3	YI3
	1 3/16	IC 3/8"	3IR16W	AVR20-3	YI3 - 1N
	1 1/4 - 1 7/16	IC 3/8"	3IR16W	AVR25-3	YI3 - 1N
	1 1/2 - 1 3/4	IC 3/8"	3IR16W	AVR32-3	YI3 - 1N
	1 7/8 - 4 5/8	IC 3/8"	3IR16W	AVR40-3	YI3 - 1N
16	4 3/4 - 7	IC 3/8"	3IR16W	AVR40-3	YI3 - 1.5N
	7/16	IC 5.0 L	5LIR14W	.NVR10.-5L	-
	5/8 - 11/16	IC 1/4"	2IR14W	NVR10-2	-
	13/16	IC 3/8"	3IR12W	NVR13-3	-
	15/16 - 1	IC 3/8"	3IR12W	NVR16-3	-
	1 1/16 - 1 3/16	IC 3/8"	3IR12W	AVR20-3	YI3
	1 1/4 - 1 1/2	IC 3/8"	3IR12W	AVR25-3	YI3
	1.6 - 1 3/4	IC 3/8"	3IR12W	AVR32-3	YI3 - 1N
	1 7/8 - 6	IC 3/8"	3IR12W	AVR40-3	YI3 - 1N
12	6 1/4 - 7	IC 3/8"	3IR12W	AVR40-3	YI3 - 1.5N
	7/8	IC 3/8"	3IR11W	NVR13-3	-
	10	1	IC 3/8"	3IR10W	NVR16-3

## Tooling recommendation for a given Internal thread specification

TT Gen Software  
and updated versions  
can be downloaded from  
[www.vargus.com](http://www.vargus.com)



### Whitworth (con't)

Pitch tpi	Thread	Insert Size	Ordering Code		Anvil
			Insert	Holder	
9	7/8	IC 3/8"	3IR9W	NVR13-3	-
	1 1/8 - 1 1/4	IC 3/8"	3IR9W	AVR20-3	Y13
8	1	IC 3/8"	3IR8W	NVR16-3	-
	1 3/16	IC 3/8"	3IR8W	AVR20-3	Y13 - 1P
	1 5/16 - 1 1/2	IC 3/8"	3IR8W	AVR25-3	Y13
	1.6 - 1 7/8	IC 3/8"	3IR8W	AVR32-3	Y13
	1.9 - 2 1/4	IC 3/8"	3IR8W	AVR40-3	Y13
	2.4 - 7	IC 3/8"	3IR8W	AVR40-3	Y13 - 1N
7	1 1/4	IC 1/2"	4IR7W	NVR20-4	-
	1 3/4 - 2	IC 1/2"	4IR7W	AVR32-4	Y14
6	1 5/16 - 1 7/16	IC 1/2"	4IR6W	NVR20-4	-
	1 1/2 - 1 5/8	IC 1/2"	4IR6W	AVR25-4	Y14 - 1P
	1 7/8 - 1.9	IC 1/2"	4IR6W	AVR32-4	Y14
	2.1 - 3.1	IC 1/2"	4IR6W	AVR40-4	Y14
	3 1/4 - 7	IC 1/2"	4IR6W	AVR40-4	Y14 - 1N
5	1 3/4	IC 1/2"	4IR5W	AVR25-4	Y14 - 1P
	3 - 3 1/4	IC 1/2"	4IR5W	AVR40-4	Y14
4.5	2	IC 5/8"	5IR4.5W	AVR32-5	Y15 - 1P
	3 1/2 - 4	IC 5/8"	5IR4.5W	AVR60-5	Y15
4	2 1/4	IC 5/8"	5IR4W	AVR40-5	Y15 - 1P
	2 1/2	IC 5/8"	5IR4W	AVR40-5	Y15
	4 1/4 - 4 3/4	IC 5/8"	5IR4W	AVR60-5	Y15
	4 7/8 - 7	IC 5/8"	5IR4W	AVR60-5	Y15 - 1N
3.5	2 3/4	IC 5/8" U	5UEI3.5W	AVR40-5U	Y15U - 1P
	3	IC 5/8" U	5UEI3.5W	AVR50-5U	Y15U
3.25	3 1/4	IC 5/8" U	5UEI3.25W	AVR50-5U	Y15U
	3 1/2	IC 5/8" U	5UEI3.25W	AVR60-5U	Y15U
3	3 3/4 - 4	IC 5/8" U	5UEI3W	AVR60-5U	Y15U
2.75	5	IC 5/8" U	5UEI2.75W	AVR60-5U	Y15U
2.5	6	IC 5/8" V	5VIR2.5W	NVR60-5V	-

## Tooling recommendation for a given Internal thread specification

TT Gen Software  
and updated versions  
can be downloaded from  
[www.vargus.com](http://www.vargus.com)



### BSP (55°)

Pitch tpi	Thread	Insert Size	Ordering Code		
			Insert	Holder	Anvil
28	G1/16	Micro 6.0	6.0SIR28W	SMC.-6.0	-
	G1/8	IC 5.0 L	5LIR28W	.NVR10.-5L	-
19	G1/4	IC 6.0	6.0IR19W	.NVR1.-6.0	-
	G3/8	IC 1/4"	2IR19W	NVR10-2	-
14	G1/2 & G5/8	IC 3/8"	3IR14W	NVR13-3	-
	G3/4 & G7/8	IC 3/8"	3IR14W	AVR20-3	YI3
11	G1 & G1 1/8 & 1 1/4	IC 3/8"	3IR11W	AVR25-3	YI3
	G1 1/2	IC 3/8"	3IR11W	AVR40-3	YI3 - 1N
	G1 3/4	IC 3/8"	3IR11W	AVR40-3	YI3 - 1N
	G2	IC 3/8"	3IR11W	AVR40-3	YI3 - 1N
	G2 1/4	IC 3/8"	3IR11W	AVR40-3	YI3 - 1N
	G2 1/2	IC 3/8"	3IR11W	AVR40-3	YI3 - 1N
	G2 3/4	IC 3/8"	3IR11W	AVR40-3	YI3 - 1N
	G3	IC 3/8"	3IR11W	AVR40-3	YI3 - 1N
	G3 1/2	IC 3/8"	3IR11W	AVR40-3	YI3 - 1N
	G4	IC 3/8"	3IR11W	AVR40-3	YI3 - 1N
	G4 1/2	IC 3/8"	3IR11W	AVR40-3	YI3 - 1N
	G5	IC 3/8"	3IR11W	AVR40-3	YI3 - 1N
	G5 1/2	IC 3/8"	3IR11W	AVR40-3	YI3 - 1N
	G6	IC 3/8"	3IR11W	AVR40-3	YI3 - 1N

### BSPT

Pitch tpi	Thread	Insert Size	Ordering Code		
			Insert	Holder	Anvil
28	1/8	IC 5.0 L	5LIR28BSPT	.NVR1.-5L	-
19	1/4	IC 6.0	6.0IR19BSPT	.NVR1.-6.0	-
	3/8	IC 1/4"	2IR19BSPT	NVR10-2	-
14	1/2	IC 3/8"	3IR14BSPT	NVR13-3	-
	3/4	IC 3/8"	3IR14BSPT	AVR20-3	YI3
11	1	IC 3/8"	3IR11BSPT	AVR25-3	YI3
	1 1/4	IC 3/8"	3IR11BSPT	AVR32-3	YI3
	1 1/2	IC 3/8"	3IR11BSPT	AVR40-3	YI3 - 1N
	2	IC 3/8"	3IR11BSPT	AVR40-3	YI3 - 1N
	2 1/2	IC 3/8"	3IR11BSPT	AVR40-3	YI3 - 1N
	3	IC 3/8"	3IR11BSPT	AVR40-3	YI3 - 1N
11	4	IC 3/8"	3IR11BSPT	AVR40-3	YI3 - 1N
	5	IC 3/8"	3IR11BSPT	AVR40-3	YI3 - 1N
	6	IC 3/8"	3IR11BSPT	AVR40-3	YI3 - 1N



# Tooling recommendation for a given Internal thread specification

TT Gen Software  
and updated versions  
can be downloaded from  
[www.vargus.com](http://www.vargus.com)



## NPT

Pitch tpi	Thread	Insert Size	Ordering Code		
			Insert	Holder	Anvil
27	1/16	Micro 6.0	6.0SIR27NPT	SMC...-6.0	-
	1/4	Micro 6.0	6.0SIR18NPT	SMC...-6.0	-
18	3/8	Micro 6.0	6.0SIR18NPT	SMC...-6.0	-
	1/2	IC 3/8"	3IR14NPT	NVR13-3	-
14	3/4	IC 3/8"	3IR14NPT	NVR13-3	-
	1	IC 3/8"	3IR11.5NPT	AVR20-3	YI3
11.5	1 1/4	IC 3/8"	3IR11.5NPT	AVR32-3	YI3
	1 1/2	IC 3/8"	3IR11.5NPT	AVR32-3	YI3 - 1N
	2	IC 3/8"	3IR11.5NPT	AVR40-3	YI3 - 1N
	2 1/2	IC 3/8"	3IR8NPT	AVR40-3	YI3 - 1N
8	3	IC 3/8"	3IR8NPT	AVR40-3	YI3 - 1N
	3 1/2	IC 3/8"	3IR8NPT	AVR40-3	YI3 - 1N
	4	IC 3/8"	3IR8NPT	AVR40-3	YI3 - 1N
	5	IC 3/8"	3IR8NPT	AVR40-3	YI3 - 1N
	6	IC 3/8"	3IR8NPT	AVR40-3	YI3 - 1N
	8	IC 3/8"	3IR8NPT	AVR40-3	YI3 - 1N
	10	IC 3/8"	3IR8NPT	AVR40-3	YI3 - 1N
	12	IC 3/8"	3IR8NPT	AVR40-3	YI3 - 1N

## NPTF

Pitch tpi	Thread	Insert Size	Ordering Code		
			Insert	Holder	Anvil
27	1/8	IC 5.0 L	5LIR27NPTF	.NVR1...-5L	-
18	1/4	IC 6.0	6.0IR18NPTF	.NVR1...-6.0	-
	3/8	IC 1/4"	2IR18NPTF	NVR10-2	-
14	1/2	IC 3/8"	3IR14NPTF	NVR13-3	-
	3/4	IC 3/8"	3IR14NPTF	NVR16-3	-
11.5	1	IC 3/8"	3IR11.5NPTF	AVR20-3	YI3
	1 1/4	IC 3/8"	3IR11.5NPTF	AVR32-3	YI3
	1 1/2	IC 3/8"	3IR11.5NPTF	AVR32-3	YI3 - 1N
	2	IC 3/8"	3IR11.5NPTF	AVR40-3	YI3 - 1N
8	2 1/2	IC 3/8"	3IR8NPTF	AVR40-3	YI3 - 1N
	3	IC 3/8"	3IR8NPTF	AVR40-3	YI3 - 1N

## PG

Pitch tpi	Thread	Insert Size	Ordering Code		
			Insert	Holder	Anvil
20	Pg 7	IC 6.0	6.0IR20PG	.NVR 1..6.0	-
	Pg 9	IC 1/4"	2IR18PG	NVR10-2	-
18	Pg 11 & Pg 13.5	IC 3/8"	3IR18PG	NVR13-3	-
	Pg 16	IC 3/8"	3IR18PG	NVR16-3	-
16	Pg 21	IC 3/8"	3IR16PG	AVR20-3	YI3
	Pg 29	IC 3/8"	3IR16PG	AVR25-3	YI3 - 1N
	Pg 36 & Pg 42 & Pg 48	IC 3/8"	3IR16PG	AVR40-3	YI3 - 1N





# Thread Turning

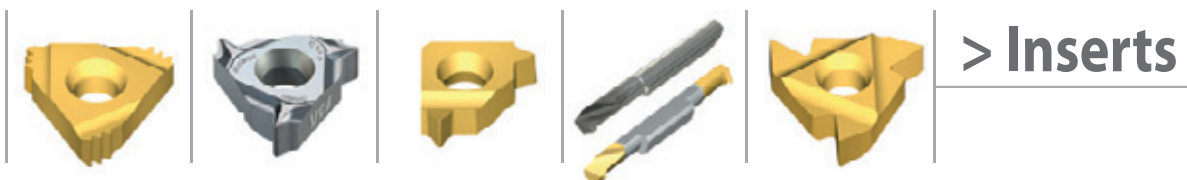

# THREAD TURNING INSERTS

■ VARDEX Ordering Code System.....	Page 18
■ Partial Profile 60°.....	Page 20
■ Partial Profile 55°.....	Page 23
■ ISO Metric.....	Page 26
■ American UN.....	Page 35
■ Whitworth for BSW, BSP.....	Page 45
■ BSPT.....	Page 53
■ NPT.....	Page 56
■ NPTF.....	Page 61
■ NPS.....	Page 64
■ Round (DIN 405).....	Page 65
■ Round (DIN 20400).....	Page 66
■ Trapez.....	Page 67
■ American ACME.....	Page 70
■ Stub ACME.....	Page 73
■ UNJ.....	Page 74
■ MJ.....	Page 81
■ American Buttress.....	Page 83
■ British Buttress.....	Page 85
■ Metric Buttress (Sägengewinde).....	Page 86
■ API.....	Page 87
■ API Buttress Casing.....	Page 88
■ API Round Casing & Tubing.....	Page 89
■ VAM.....	Page 91
■ EL-Extreme Line.....	Page 92
■ Hughes H-90.....	Page 93
■ Pg.....	Page 94

## microscope Inserts Ordering Code System

### Micro Threading Inserts - Single Ended

<b>M</b>	<b>5</b>	<b>42</b>	<b>TH</b>	<b>0.5</b>	<b>ISO</b>	<b>L16</b>	<b>R/L</b>	<b>VBX</b>
<b>1</b>	<b>2</b>	<b>3</b>	<b>4</b>	<b>5</b>	<b>6</b>	<b>7</b>	<b>8</b>	<b>9</b>







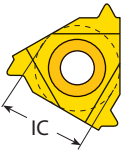

<b>1 - Product Line</b>	<b>2 - Insert Size</b>	<b>3 - Min. Bore Dia.</b>
M - Microscope	4, 5, 6, 7	3.2, 4.2, ...

<b>4 - Type of Application</b>	<b>5 - Pitch (for Threading)</b>	<b>6 - Threading Standard</b>														
TH - Threading	<table border="1"> <tr><th colspan="2">Full Profile - Pitch Range</th></tr> <tr><td>mm</td><td>tpi</td></tr> <tr><td>0.5-1.5</td><td>28-18</td></tr> <tr><th colspan="2">Partial Profile - Pitch Range</th></tr> <tr><td>mm</td><td>tpi</td></tr> <tr><td>A 0.5 - 1.5</td><td>A 48 - 16</td></tr> <tr><td>F 0.5 - 1.0</td><td>F 48 - 24</td></tr> </table>	Full Profile - Pitch Range		mm	tpi	0.5-1.5	28-18	Partial Profile - Pitch Range		mm	tpi	A 0.5 - 1.5	A 48 - 16	F 0.5 - 1.0	F 48 - 24	ISO - ISO Metric UN - American UN W - Whitworth for BSW, BSP NPT - NPT 60° - Partial Profile 60° 55° - Partial Profile 55°
Full Profile - Pitch Range																
mm	tpi															
0.5-1.5	28-18															
Partial Profile - Pitch Range																
mm	tpi															
A 0.5 - 1.5	A 48 - 16															
F 0.5 - 1.0	F 48 - 24															

<b>7 - Overhang</b>	<b>8 - LH or RH</b>	<b>9 - Carbide Grades</b>
L16	R - RH L - LH	VBX

# Vardex Ordering Code System

## Threading Inserts (Not Including Micro and Microscope Systems)

<b>3</b>		<b>E</b>	<b>R</b>	<b>1.5</b>	<b>ISO</b>					<b>VTX</b>		
<b>1</b>	<b>2</b>	<b>3</b>	<b>4</b>	<b>5</b>	<b>6</b>	<b>7</b>	<b>8</b>	<b>9</b>	<b>10</b>	<b>11</b>	<b>12</b>	
<b>1 - Insert Size</b> 5L - IC5.0L mm 4.0K - IC4.0 mm 6.0 - IC6.0 mm 2 - IC1/4" 3 - IC 3/8" 4 - IC 1/2" 5 - IC5/8" 		<b>2 - Insert Style</b> U  V  L  J  SCB		<b>3 - Type of Insert</b> E - External I - Internal EI - External +Internal			<b>4 - RH/LH Insert</b> R - Right Hand Insert L - Left Hand Insert None - Right + Left Insert					
<b>5 - Pitch</b> <b>Full Profile - Pitch Range</b> mm      tpi 0.35-12.0      72-2 <b>Partial Profile - Pitch Range</b> mm      tpi A    0.5 - 1.5    48 -16 AG   0.5 - 3.0    48 - 8 G    1.75 - 3.0    14 - 8 N    3.5 - 5.0    7 - 5 U    5.5 - 8.0    4½ - 3½ Q    5.5 - 6.0    4½ - 4 U    6.5 - 9.0    4 - 2¾ V    6.0 - 10.0    4 - 2½		<b>6 - Standard</b> 60° - Partial Profile 60° 55° - Partial Profile 55° ISO - ISO Metric UN - American UN W - Whitworth for BSW, BSP BSPT - British Standard Pipe Thread NPT - NPT NPTF - NPTF NPS - NPS RD - Round DIN 405 RD20400 - Round DIN 20400 TR - Tarpez DIN 103 ACME - ACME STACME - Stub ACME UNJ - UNJ MJ - ISO 5855 ABOUT - American Butters BBUT - British Buttress SAGE - Metric Buttress DIN 513 API - API BUT - API Buttress Casing APPIRD - API Round Casing & Tubing VAM - VAM EL - Extreme Line Casing H90 - H90 PG - Pg DIN 40430			<b>7 - No. of Cutting Corners</b> 6C - V6 Cutting Corners None - All Others <b>8 - API Form</b> 382    2 383    3 403    15 502    75 503    125 <b>9 - No. of Teeth</b> (for multitooth Style) 2, 3, 5, 6, 8							
<b>10 - Multi tooth Style</b> M+  T+  Z+  <b>Multiplus</b>		<b>11 - Carbide Grade</b> VKX, VTX, VCB, VM7, VK2, VK2P, VKP, VHx, VBX			<b>12 - Coarse Pitch Inserts</b> 158/...							

## Micro Threading Inserts - Double Ended

<b>3</b>	<b>S</b>	<b>I</b>	<b>R</b>	<b>0.5</b>	<b>ISO</b>	<b>VMX</b>		
<b>1</b>	<b>2</b>	<b>3</b>	<b>4</b>	<b>5</b>	<b>6</b>	<b>7</b>		
<b>1 - Insert Dia.</b> 3.0 - 3.0 mm 4.0 - 4.0 mm 6.0 - 6.0 mm 8.0 - 8.0 mm 10.0 - 10.0 mm		<b>2 - Insert Style</b> S - Micro Insert		<b>3 - Type of Insert</b> I - Internal		<b>4 - RH/LH Insert</b> R - Right Hand Insert L - Left Hand Insert		
<b>5 - Pitch</b> <b>Full Profile - Pitch Range</b> mm      tpi 0.30-1.5      40-16 <b>Partial Profile - Pitch Range</b> mm      tpi A    0.5 - 1.5    A    48 - 16 F    0.5 - 3.0    F    48 - 24			<b>6 - Standard</b> 60° - Partial Profile 60° 55° - Partial Profile 55° ISO - ISO Metric MJ - ISO 5855 NPT - NPT NPTF - NPTF UN - American UN W - Whitworth for BSW, BSP				<b>7 - Carbide Grades</b> VMX	

# Partial Profile 60°

## External

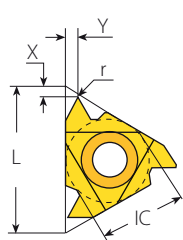
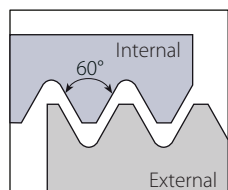

Standard

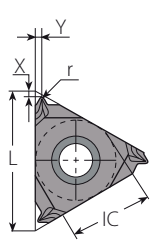

SCB  
Sintered  
Chipbreaker

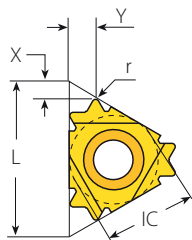

V6

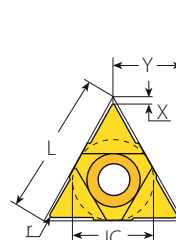

U Style

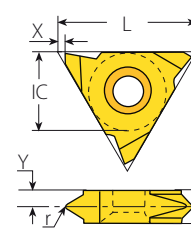

V Style / Slim Throat

## Standard



Insert Size	Pitch			Ordering Code		Dimensions mm			Anvil		Toolholder
	IC	L mm	mm tpi	RH	LH	r	X	Y	RH	LH	
1/4"	11	0.5-1.5	48-16	2ERA60...	2ELA60...	0.05	0.8	0.9	-	-	NL...-2 (LH)
		0.5-1.5	48-16	3ERA60...	3ELA60...	0.05	0.8	0.9			
3/8"	16	1.75-3.0	14-8	3ERG60...	3ELG60...	0.27	1.2	1.7	YE3	YI3	AL...-3 (LH)
		0.5-3.0	48-8	3ERAG60...	3ELAG60...	0.08	1.2	1.7			
3/8" SCB	16	0.5-1.5	48-16	3JERA60...		0.05	0.6	0.8			
		1.75-3.0	14-8	3JERG60...		0.27	1.1	1.5	YE3	-	AL...-3
		0.5-3.0	48-8	3JERAG60...		0.08	0.9	1.5			
3/8" V6	16	0.5-2.0	48-13	3ERS60-6C...		0.06	1.9	3.0	YE3-6C	-	AL...-3
1/2"	22	3.5-5.0	7-5	4ERN60...	4ELN60...	0.53	1.7	2.5	YE4	YI4	AL...-4 (LH)
5/8"	27	5.5-6.0	4.5-4	5ERQ60...	5ELQ60...	0.64	2.1	3.1	YE5	YI5	AL...-5 (LH)

## U Style



Insert Size	Pitch			Ordering Code		Dimensions mm			Anvil		Toolholder
	IC	L mm	mm tpi	RH+LH		r	X	Y	RH	LH	
1/2"U	22	5.5-8.0	4.5-3.25	4UEIU60...		0.30	0.6	11.0	YE4U	YI4U	AL...-4U (LH)
5/8"U	27	6.5-9.0	4-2.75	5UEIU60...		0.37	1.0	13.7	YE5U	YI5U	AL...-5U (LH)

## Slim Throat



Insert Size	Pitch			Ordering Code		Dimensions mm				Toolholder
	IC	L mm	mm tpi	RH	LH	r	X	Y	T	
1/4"V	11	0.5-1.5	48-16	2VERA60...	2VELA60...	0.05	0.69	2.3	3.2	NL...-2V (LH)
		0.5-1.5	48-16	3VERA60...	3VELA60...	0.05	1.10	2.7	3.6	
3/8"V	16	1.75-3.0	14-8	3VERG60...	3VELG60...	0.27	1.10	1.9	3.6	NL...-3V (LH)
		0.5-3.0	48-8	3VERAG60...	3VELAG60...	0.08	1.10	1.9	3.6	
1/2"V	22	3.5-5.0	7-5	4VERN60...	4VELN60...	0.53	1.10	2.3	4.8	NL...-4V (LH)

## V Style



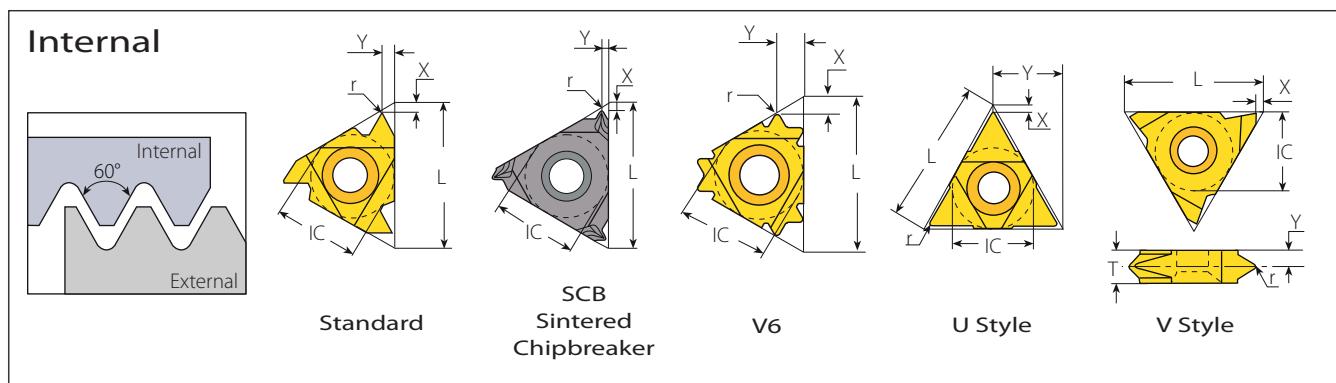

Insert Size	Pitch			Ordering Code		Dimensions mm				Toolholder
	IC	L mm	mm tpi	RH	LH	r	X	Y	T	
5/8"V	27	6.0-10.0	4-2.5	5VERV60...	5VELV60...	0.75	0.6	5.2	10	NL...-5V-10 (LH)

## Partial Profile 60° (con't)

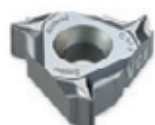

### Standard

	Insert Size		Pitch		Ordering Code		Dimensions mm			Anvil		
	IC	L mm	mm	tpi	RH	LH	r	X	Y	RH	LH	Toolholder
	1/4"	11	0.5-1.5	48-16	2IRA60...	2ILA60...	0.05	0.8	0.9	-	-	NVR..-2 (LH)
	1/4" SCB	11	0.5-1.5	48-16	2JIRA60...		0.05	0.6	0.8	-	-	NVR..-2
	3/8"	16	0.5-1.5	48-16	3IRA60...	3ILA60...	0.05	0.8	0.9	YI3	YE3	AVR..-3 (LH)
			1.75-3.0	14-8	3IRG60...	3ILG60...	0.16	1.2	1.7			
			0.5-3.0	48-8	3IRAG60...	3ILAG60...	0.05	1.2	1.7			
	3/8" SCB	16	0.5-1.5	48-16	3JIRA60...		0.05	0.6	0.8	YI3	-	AVR..-3
			1.75-3.0	14-8	3JIRG60...		0.16	1.0	1.5			
			0.5-3.0	48-8	3JIRAG60...		0.05	0.9	1.5			
	3/8" V6	16	0.5-2.0	48-14	3IRS60-6C...		0.03	1.6	2.6	YI3-6C	-	AVR..-3 NVRC..-3 206/..
	1/2"	22	3.5-5.0	7-5	4IRN60...	4ILN60...	0.30	1.7	2.5	YI4	YE4	AVR..-4 (LH)
	5/8"	27	5.5-6.0	4.5-4	5IRQ60...	5ILQ60...	0.30	1.8	2.7	YI5	YE5	AVR..-5 (LH)

### U Style

	Insert Size		Pitch		Ordering Code		Dimensions mm			Anvil		
	IC	L mm	mm	tpi	RH+LH		r	X	Y	RH	LH	Toolholder
	1/2"U	22	5.5-8.0	4.5-3.25	4UEIU60...		0.30	0.6	11.0	YI4U	YE4U	AVR..-4U (LH)
	5/8"U	27	6.5-9.0	4-2.75	5UEIU60...		0.37	1.0	13.7	YI5U	YE5U	AVR..-5U (LH)

### V Style

	Insert Size		Pitch		Ordering Code		Dimensions mm				
	IC	L mm	mm	tpi	RH	LH	r	X	Y	T	Toolholder
	5/8"V	27	6.0-10.0	4-2.5	5VIRV60...	5VILV60...	0.35	1.0	4.3	8	NVR..-5V (LH)

## Partial Profile 60° (con't)



### Internal

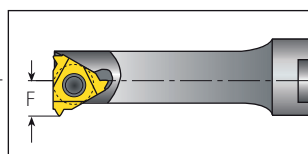
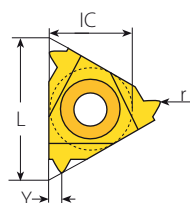
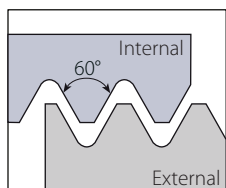

Mini-3

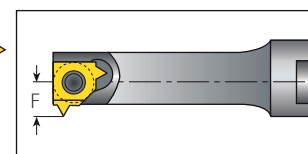
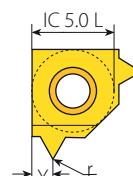

Mini-L

### Mini-3



Insert Size		Pitch		Ordering Code	Dimensions mm			Min. Bore dia.	Toolholder
IC	L mm	mm	tpi	RH	r	Y	F	mm	
4.0	6	0.5-1.25	48-20	4.0KIRA60...	0.05	0.6	3.7	6.35	.NVR.5-4.0K
6.0	10	0.5-1.5	48-16	6.0IRA60...	0.05	0.9	5.3	10.00	.NVR 1.-6.0

### Mini-L



Insert Size	Pitch	Ordering Code	Dimensions mm	Min. Bore dia.	Toolholder			
IC	mm	tpi	RH	r	Y	F	mm	
5.0L	0.5-1.5	48-16	5LIRA60...	0.05	0.9	4.65	8.0	.NVR 10.-5L

### Internal

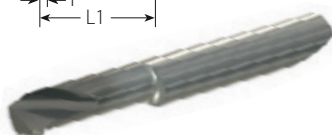
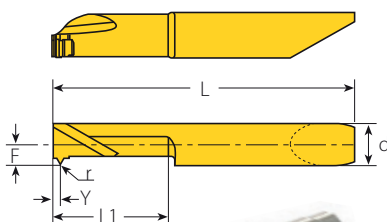
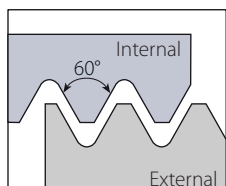

RH-Single Ended

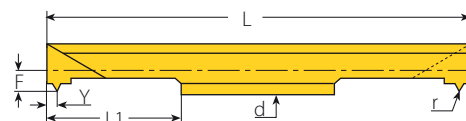

RH-Double Ended

### Micro - Double Ended

Insert dia.		Pitch	Ordering Code	Dimensions mm			Min. Bore dia.	Toolholder		
d mm	mm	tpi	RH/LH	r	L1	L	F	Y	mm	
3.0	0.5-1.0	48-24	3.0SIRF60...	0.05	16	50	1.46	0.9	3.3	SMC.-3.0
4.0	0.5-1.0	48-24	4.0SIRF60...	0.05	16	50	1.96	0.9	4.3	SMC.-4.0
6.0	0.5-1.5	48-16	6.0SIRA60...	0.05	16	50	2.50	0.9	6.0	SMC.-6.0

Left Handed Tool Supplied by Request. (Example: 6.0SILA60...)

### Micro - Single Ended



Insert dia.		Pitch	Ordering Code	Dimensions mm			Min. Bore dia.	Toolholder		
d mm	mm	tpi	RH/LH	r	L1	L	F	Y	mm	
4.0	0.5-1.0	48-24	M429THF60L16R/L	0.05	16	33	0.9	0.9	3.2	MHC.-4
4.0	0.5-1.0	48-24	M439THF60L16R/L	0.05	16	33	1.9	0.9	4.2	MHC.-4
6.0	0.5-1.5	48-16	M659THA60L16R/L	0.05	16	42	2.9	0.9	6.2	MHC.-6





Left Handed Tool Supplied by Request. (Example: M429THF60L16L)

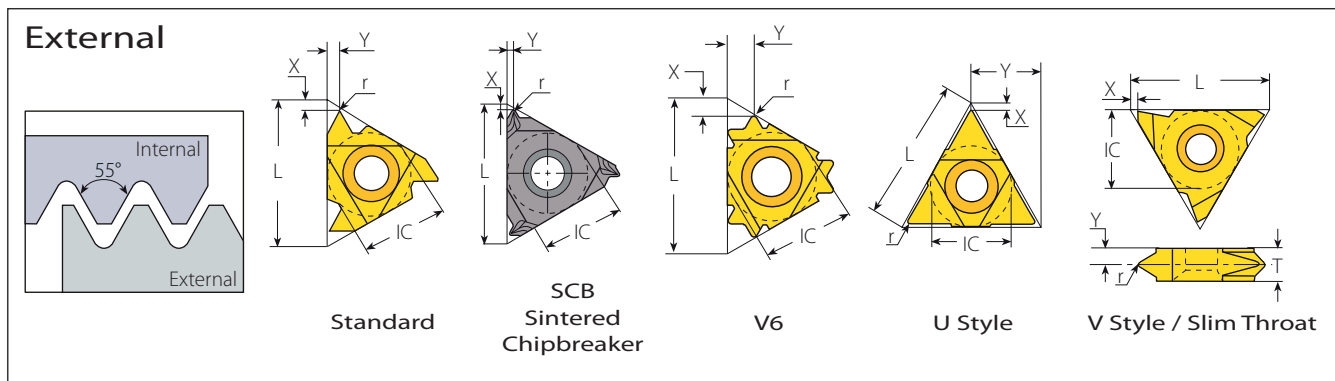

## Partial Profile 55°



### Standard

	Insert Size		Pitch		Ordering Code		Dimensions mm			Anvil		Toolholder
	IC	L mm	mm	tpi	RH	LH	r	X	Y	RH	LH	
	1/4"	11	0.5-1.5	48-16	2ERA55...	2ELA55...	0.05	0.8	0.9	-	-	NL...-2 (LH)
			0.5-1.5	48-16	3ERA55...	3ELA55...	0.05	0.8	0.9			
	3/8"	16	1.75-3.0	14-8	3ERG55...	3ELG55...	0.21	1.2	1.7	YE3	YI3	AL...-3 (LH)
			0.5-3.0	48-8	3ERAG55...	3ELAG55...	0.07	1.2	1.7			
	3/8" SCB	16	0.5-1.5	48-16	3JERA55...		0.05	0.6	0.8			
			1.75-3.0	14-8	3JERG55...		0.21	1.1	1.5	YE3	-	AL...-3
			0.5-3.0	48-8	3JERAG55...		0.07	0.9	1.5			
	3/8"V6	16	-	48-14	3ERS55-6C...		0.05	1.8	2.8	YE3-6C	-	AL...-3
	1/2"	22	3.5-5.0	7-5	4ERN55...	4ELN55...	0.43	1.7	2.5	YE4	YI4	AL...-4 (LH)
	5/8"	27	5.5-6.0	4,5-4	5ERQ55...	5ELQ55...	0.60	2.0	2.9	YE5	YI5	AL...-5 (LH)

### U Style

	Insert Size		Pitch		Ordering Code		Dimensions mm			Anvil		Toolholder
	IC	L mm	mm	tpi	RH+LH		r	X	Y	RH	LH	
	1/2"U	22	5.5-8.0	4.5-3.25	4UEIU55...		0.60	0.9	11.0	YE4U	YI4U	AL...-4U (LH)
	5/8"U	27	6.5-9.0	4-2.75	5UEIU55...		0.80	1.2	13.7	YE5U	YI5U	AL...-5U (LH)

### Slim Throat

	Insert Size		Pitch		Ordering Code		Dimensions mm				Toolholder
	IC	L mm	mm	tpi	RH	LH	r	X	Y	T	
	1/4"V	11	0.5-1.5	48-16	2VERA55...	2VELA55...	0.05	0.8	2.7	3.2	NL...-2V (LH)
			0.5-1.5	48-16	3VERA55...	3VELA55...	0.05	1.1	2.7	3.6	
	3/8"V	16	1.75-3.0	14-8	3VERG55...	3VELG55...	0.21	1.1	1.9	3.6	NL...-3V (LH)
			0.5-3.0	48-8	3VERAG55...	3VELAG55...	0.07	1.1	1.9	3.6	
1/2"V	22	3.5-5.0	7-5	4VERN55...	4VELN55...	0.43	1.1	2.3	4.8	NL...-4V (LH)	

### V Style

	Insert Size		Pitch		Ordering Code		Dimensions mm				Toolholder
	IC	L mm	mm	tpi	RH	LH	r	X	Y	T	
	5/8"V	27	6.0-9.0	4-2.75	5VERV55...	5VELV55...	0.70	1.0	4.3	8	NL...-5V-8 (LH)

## Partial Profile 55° (con't)

### Internal

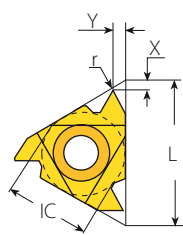
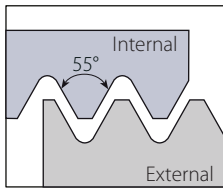

Standard

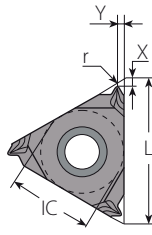

SCB  
Sintered  
Chipbreaker

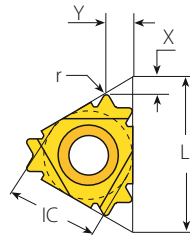

V6

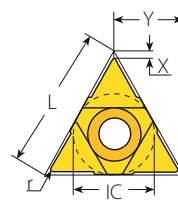

U Style

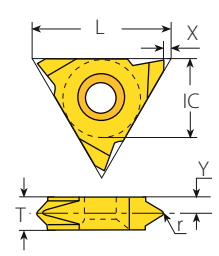

V Style

### Standard

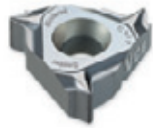

SCB



V6

IC	Insert Size		Pitch		Ordering Code		Dimensions mm			Anvil		Toolholder
	L mm	mm	tpi	RH	LH	r	X	Y	RH	LH		
1/4"	11	0.5-1.5	48-16	2IRA55...	2ILA55...	0.05	0.8	0.9	-	-	NVR..-2 (LH)	
1/4" SCB	11	0.5-1.5	48-16	2JIRA55...		0.05	0.6	0.8	-	-	NVR..-2	
3/8"	16	0.5-1.5	48-16	3IRA55...	3ILA55...	0.05	0.8	0.9	YI3	YE3	AVR..-3 (LH)	
		1.75-3.0	14-8	3IRG55...	3ILG55...	0.21	1.2	1.7				
		0.5-3.0	48-8	3IRAG55...	3ILAG55...	0.07	1.2	1.7				
3/8" SCB	16	0.5-1.5	48-16	3JIRA55...		0.05	0.6	0.8	YI3	-	AVR..-3	
		1.75-3.0	14-8	3JIRG55...		0.21	1.1	1.5				
		0.5-3.0	48-8	3JIRAG55...		0.07	0.9	1.5				
3/8" V6	16	-	48-16	3IRS55-6C...		0.05	1.6	2.6	YI3-6C	-	AVR..-3 NVR..-3 206/...	
1/2"	22	3.5-5.0	7-5	4IRN55...	4ILN55...	0.43	1.7	2.5	YI4	YE4	AVR..-4 (LH)	
5/8"	27	5.5-6.0	4.5-4	5IRQ55...	5ILQ55...	0.60	2.0	2.9	YI5	YE5	AVR..-5 (LH)	

### U Style



IC	Insert Size		Pitch		Ordering Code		Dimensions mm			Anvil		Toolholder
	L mm	mm	tpi	RH+LH	r	X	Y	RH	LH			
1/2"U	22	5.5-8.0	4.5-3.25	4UEIU55...		0.60	0.9	11.0	YI4U	YE4U	AVR..-4U (LH)	
5/8"U	27	6.5-9.0	4-2.75	5UEIU55...		0.80	1.2	13.7	YI5U	YE5U	AVR..-5U (LH)	

### V Style



IC	Insert Size		Pitch		Ordering Code		Dimensions mm				Toolholder
	L mm	mm	tpi	RH	LH	r	X	Y	T		
5/8"V	27	6.0-9.0	4-2.75	5VIRV55...	5VILV55...	0.70	1.0	4.3	8	NVR..-5V (LH)	

## Partial Profile 55° (con't)

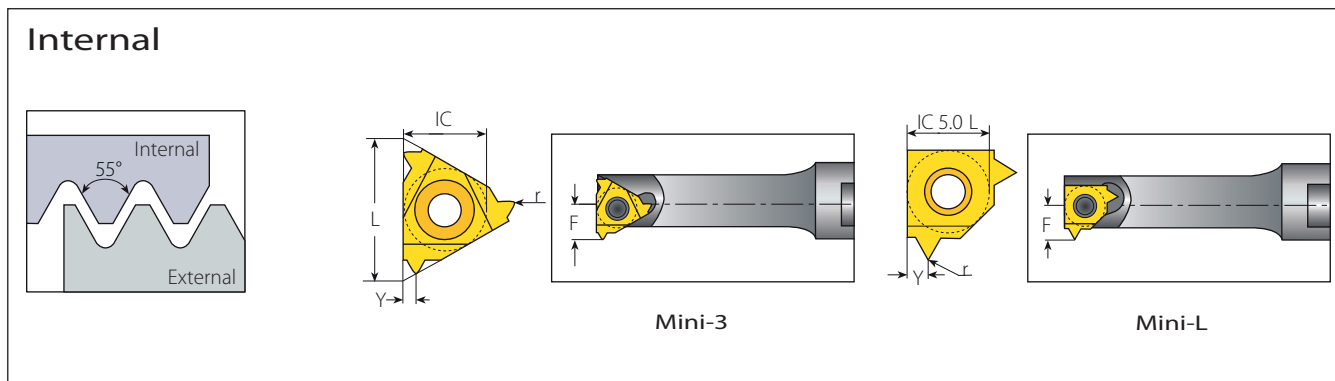

### Mini-3



Insert Size		Pitch		Ordering Code	Dimensions mm			Min. Bore dia.	Toolholder
IC	L mm	mm	tpi	RH	r	Y	F	mm	
4.0	6	0.5-1.25	48-20	4.0KIRA55...	0.05	0.6	3.8	6.45	.NVR.5-4.0K
6.0	10	0.5-1.50	48-16	6.0IRA55...	0.05	0.9	5.3	10.00	.NVR 1..-6.0

### Mini-L



Insert Size		Pitch		Ordering Code	Dimensions mm			Min. Bore dia.	Toolholder
IC	mm	mm	tpi	RH	r	Y	F	mm	
5.0L		0.5-1.5	48-16	5LIRA55...	0.05	0.9	4.65	8.0	.NVR 10-5L

## Partial Profile 55°

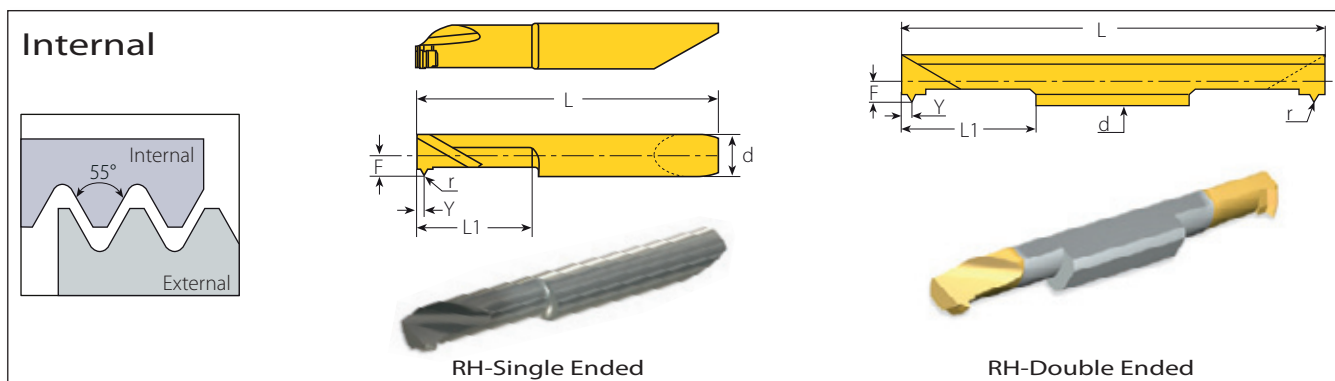

### Micro - Double Ended

Insert dia.		Pitch		Ordering Code	Dimensions mm					Min. Bore dia.	Toolholder
d mm	mm	mm	tpi	RH/LH	r	L1	L	F	Y	mm	
3.0	0.5-1.0	48-24		3.0SIRF55...	0.05	16	50	1.46	0.9	3.3	SMC..-3.0
4.0	0.5-1.0	48-24		4.0SIRF55...	0.05	16	50	1.96	0.9	4.3	SMC..-4.0
6.0	0.5-1.5	48-16		6.0SIRA55...	0.05	16	50	2.50	0.9	6.0	SMC..-6.0

Left Handed Tool Supplied by Request. (Example: 6.0SILA55...)

### Micro - Single Ended

**microscope**

Insert dia.		Pitch		Ordering Code	Dimensions mm					Min. Bore dia.	Toolholder
d mm	mm	mm	tpi	RH/LH	r	L1	L	F	Y	mm	
4.0	0.5-1.0	48-24		M429TH F55 L16R/L	0.05	16	33	0.9	0.75	3.2	MHC..-4
4.0	0.5-1.0	48-24		M439TH F55 L16R/L	0.05	16	33	1.9	0.75	4.2	MHC..-4
6.0	0.5-1.5	48-16		M659TH A55 L16R/L	0.05	16	42	2.9	0.9	6.2	MHC..-6

Left Handed Tool Supplied by Request. (Example: M429TH F55 L16L)

# ISO Metric

## External

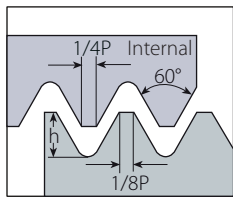

Defined by: R262 (DIN 13)  
Tolerance class: 6g/6H

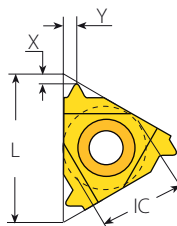

Standard

## Standard

Insert Size		Pitch	Ordering Code		Dimensions mm			Anvil		Toolholder
IC	L mm	mm	RH	LH	h min	X	Y	RH	LH	
1/4"	11	0.25	2ER0.25ISO...	2EL0.25ISO...	0.14	0.4	0.2	-	-	NL..-2 (LH)
		0.3	2ER0.3ISO...	2EL0.3ISO...	0.19	0.7	0.3			
		0.35	2ER0.35ISO...	2EL0.35ISO...	0.21	0.8	0.4			
		0.4	2ER0.4ISO...	2EL0.4ISO...	0.25	0.7	0.4			
		0.45	2ER0.45ISO...	2EL0.45ISO...	0.28	0.7	0.4			
		0.5	2ER0.5ISO...	2EL0.5ISO...	0.31	0.6	0.4			
		0.6	2ER0.6ISO...	2EL0.6ISO...	0.37	0.6	0.6			
		0.7	2ER0.7ISO...	2EL0.7ISO...	0.43	0.6	0.6			
		0.75	2ER0.75ISO...	2EL0.75ISO...	0.46	0.6	0.6			
		0.8	2ER0.8ISO...	2EL0.8ISO...	0.49	0.6	0.6			
		1.0	2ER1.0ISO...	2EL1.0ISO...	0.61	0.7	0.7			
		1.25	2ER1.25ISO...	2EL1.25ISO...	0.77	0.8	0.9			
		1.5	2ER1.5ISO...	2EL1.5ISO...	0.92	0.8	1.0			
1.75	2ER1.75ISO...	2EL1.75ISO...	1.07	0.8	1.1					
3/8"	16	0.25	3ER0.25ISO...	3EL0.25ISO...	0.14	0.4	0.2	YE3	YI3	AL..-3 (LH)
		0.35	3ER0.35ISO...	3EL0.35ISO...	0.21	0.8	0.4			
		0.4	3ER0.4ISO...	3EL0.4ISO...	0.25	0.7	0.4			
		0.45	3ER0.45ISO...	3EL0.45ISO...	0.28	0.7	0.4			
		0.5	3ER0.5ISO...	3EL0.5ISO...	0.31	0.6	0.4			
		0.6	3ER0.6ISO...	3EL0.6ISO...	0.37	0.6	0.6			
		0.7	3ER0.7ISO...	3EL0.7ISO...	0.43	0.6	0.6			
		0.75	3ER0.75ISO...	3EL0.75ISO...	0.46	0.6	0.6			
		0.8	3ER0.8ISO...	3EL0.8ISO...	0.49	0.6	0.6			
		1.0	3ER1.0ISO...	3EL1.0ISO...	0.61	0.7	0.7			
		1.25	3ER1.25ISO...	3EL1.25ISO...	0.77	0.8	0.9			
		1.5	3ER1.5ISO...	3EL1.5ISO...	0.92	0.8	1.0			
		1.75	3ER1.75ISO...	3EL1.75ISO...	1.07	0.9	1.2			
		2.0	3ER2.0ISO...	3EL2.0ISO...	1.23	1.0	1.3			
		2.5	3ER2.5ISO...	3EL2.5ISO...	1.53	1.1	1.5			
3.0	3ER3.0ISO...	3EL3.0ISO...	1.84	1.2	1.6					
3.5	3ER3.5ISO...	3EL3.5ISO...	2.15	1.6	1.9					



continued on next page ▶

## ISO Metric (con't)

### External

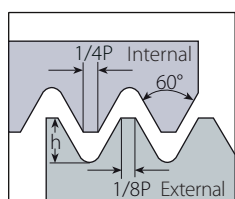

Defined by: R262 (DIN 13)  
Tolerance class: 6g/6H

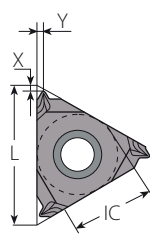

**SCB**  
Sintered  
Chipbreaker

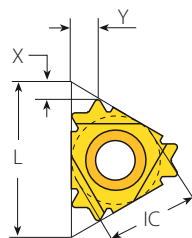

**V6**

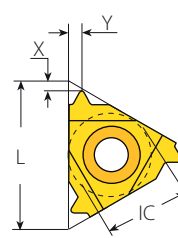

**Standard**

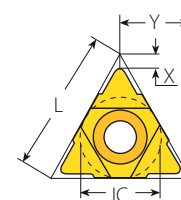

**U Style**

### Standard



SCB



V6



Insert Size		Pitch	Ordering Code		Dimensions mm			Anvil		Toolholder
IC	L mm	mm	RH	LH	h min	X	Y	RH	LH	
3/8" SCB	16	0.5	3JER0.5ISO...		0.31	1.2	0.5	YE3	-	AL..-3
		0.75	3JER0.75ISO...		0.46	1.2	0.5			
		0.8	3JER0.8ISO...		0.49	1.2	0.5			
		1.0	3JER1.0ISO...		0.61	0.7	0.8			
		1.25	3JER1.25ISO...		0.77	0.7	0.8			
		1.5	3JER1.5ISO...		0.92	0.7	0.8			
		1.75	3JER1.75ISO...		1.07	1.2	1.5			
		2.0	3JER2.0ISO...		1.23	1.2	1.5			
		2.5	3JER2.5ISO...		1.53	1.2	1.5			
		3.0	3JER3.0ISO...		1.84	1.3	1.5			
3/8" V6	16	0.5	3ER0.5ISO-6C...		0.31	2.2	1.8	YE3-6C	-	AL..-3
		0.75	3ER0.75ISO-6C...		0.46	2.0	1.8			
		0.8	3ER0.8ISO-6C...		0.49	2.0	1.9			
		1.0	3ER1.0ISO-6C...		0.61	1.9	2.0			
		1.25	3ER1.25ISO-6C...		0.77	1.8	2.1			
		1.5	3ER1.5ISO-6C...		0.92	1.9	2.4			
		1.75	3ER1.75ISO-6C...		1.07	1.8	2.6			
		2.0	3ER2.0ISO-6C...		1.23	1.9	2.8			
1/2"	22	3.5	4ER3.5ISO...	4EL3.5ISO...	2.15	1.6	2.3	YE4	YI4	AL..-4 (LH)
		4.0	4ER4.0ISO...	4EL4.0ISO...	2.45	1.6	2.3			
		4.5	4ER4.5ISO...	4EL4.5ISO...	2.76	1.7	2.4			
		5.0	4ER5.0ISO...	4EL5.0ISO...	3.07	1.7	2.5			
		6.0	4ER6.0ISO...	4EL6.0ISO...	3.68	2.0	2.9			
5/8"	27	5.5	5ER5.5ISO...	5EL5.5ISO...	3.37	1.9	2.7	YE5	YI5	AL..-5 (LH)
		6.0	5ER6.0ISO...	5EL6.0ISO...	3.68	2.0	2.9			

### U Style



Insert Size		Pitch	Ordering Code	Dimensions mm			Anvil		Toolholder
IC	L mm	mm	RH+LH	h min	X	Y	RH	LH	
1/2"U	22	5.0	4UE5.0ISO...	3.07	2.2	11.0	YE4U	YI4U	AL..-4U (LH)
		5.5	4UE5.5ISO...	3.37	2.3	11.0			
		6.0	4UE6.0ISO...	3.68	2.6	11.0			
5/8"U	27	8.0	5UE8.0ISO...	4.91	2.4	13.7	YE5U	YI5U	AL..-5U (LH)

## ISO Metric (con't)

### External

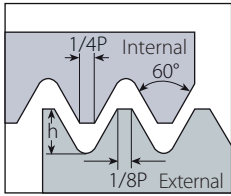

Defined by: R262 (DIN 13)  
Tolerance class: 6g/6H

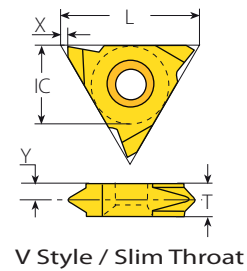

V Style / Slim Throat

### Slim Throat

Insert Size		Pitch	Ordering Code		Dimensions mm				Toolholder
IC	L mm	mm	RH	LH	h min	X	Y	T	
1/4"V	11	0.75	2VER0.75ISO...	2VEL0.75ISO...	0.46	0.7	2.6	3.2	NL...-2V (LH)
		1.0	2VER1.0ISO...	2VEL1.0ISO...	0.61	0.7	2.5	3.2	
		1.5	2VER1.5ISO...	2VEL1.5ISO...	0.92	0.7	2.2	3.2	
		1.75	2VER1.75ISO...	2VEL1.75ISO...	1.07	0.7	2.1	3.2	
		2.0	2VER2.0ISO...	2VEL2.0ISO...	1.23	0.7	1.9	3.2	
3/8"V	16	0.35	3VER0.35ISO...	3VEL0.35ISO...	0.20	1.1	3.25	3.6	NL...-3V (LH)
		0.4	3VER0.4ISO...	3VEL0.4ISO...	0.25	1.1	3.20	3.6	
		0.5	3VER0.5ISO...	3VEL0.5ISO...	0.31	1.1	3.0	3.6	
		0.75	3VER0.75ISO...	3VEL0.75ISO...	0.46	1.1	3.0	3.6	
		0.8	3VER0.8ISO...	3VEL0.8ISO...	0.49	1.1	3.0	3.6	
		1.0	3VER1.0ISO...	3VEL1.0ISO...	0.61	1.1	2.9	3.6	
		1.25	3VER1.25ISO...	3VEL1.25ISO...	0.77	1.1	2.7	3.6	
		1.5	3VER1.5ISO...	3VEL1.5ISO...	0.92	1.1	2.6	3.6	
		1.75	3VER1.75ISO...	3VEL1.75ISO...	1.07	1.1	2.45	3.6	
		2.0	3VER2.0ISO...	3VEL2.0ISO...	1.23	1.1	2.3	3.6	
		2.5	3VER2.5ISO...	3VEL2.5ISO...	1.53	1.1	2.1	3.6	
3.0	3VER3.0ISO...	3VEL3.0ISO...	1.84	1.1	2.0	3.6			



### V Style

Insert Size		Pitch	Ordering Code		Dimensions mm				Toolholder
IC	L mm	mm	RH	LH	h min	X	Y	T	
5/8"V	27	5.5	5VER5.5ISO...	5VEL5.5ISO...	3.37	1.0	3.3	6	NL...-5V-6 (LH)
		6.0	5VER6.0ISO...	5VEL6.0ISO...	3.68	1.0	3.3	6	
		8.0	5VER8.0ISO...	5VEL8.0ISO...	4.91	1.0	4.3	8	NL...-5V-8 (LH)
		10.0	5VER10.0ISO...	5VEL10.0ISO...	6.13	1.0	5.2	10	NL...-5V-10 (LH)



## ISO Metric (con't)

### External

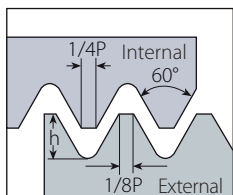

Defined by: R262 (DIN 13)  
Tolerance class: 6g/6H

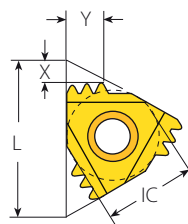

M+ Style

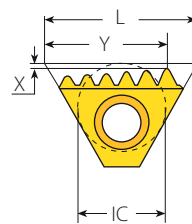

T+ Style

### M+ Style



Insert Size		Pitch	Teeth	Ordering Code	Dimensions mm			Anvil	
IC	L mm	mm		RH	h min	X	Y	RH	Toolholder
3/8"	16	1.0	3	3ER1.0ISO3M+...	0.61	1.8	2.6		
		1.5	2	3ER1.5ISO2M+...	0.92	1.6	2.4	YE3M	AL..-3
		2.0	2	3ER2.0ISO2M+...	1.23	2.1	3.1		
1/2"	22	1.5	3	4ER1.5ISO3M+...	0.92	2.5	3.8		
		2.0	2	4ER2.0ISO2M+...	1.23	2.1	3.1	YE4M	AL..-4
		2.0	3	4ER2.0ISO3M+...	1.23	3.2	5.1		
		2.5	2	4ER2.5ISO2M+...	1.53	2.5	3.9		
5/8"	27	3.0	2	5ER3.0ISO2M+...	1.84	3.0	4.7	YE5M	AL..-5M

### T+ Style



Insert Size		Pitch	Teeth	Ordering Code	Dimensions mm			Anvil	
IC	L mm	mm		RH	h min	X	Y	RH	Toolholder
1/2"	22	1.5	8	4ER1.5ISO8T+...	0.92	0.2	12.4	Y4T	AL..-4T
		2.0	8	4ER2.0ISO8T+...	1.23	0.2	17.5		

# ISO Metric (con't)

## Internal

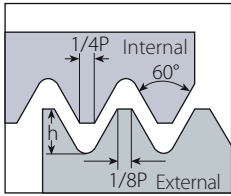

Defined by: R262 (DIN 13)  
Tolerance class: 6g/6H

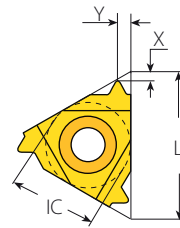

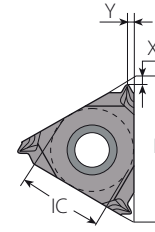

Standard



SCB  
Sintered  
Chipbreaker

## Standard

Insert Size		Pitch	Ordering Code		Dimensions mm			Anvil		Toolholder	
IC	L mm	mm	RH	LH	h min	X	Y	RH	LH		
	1/4"	11	0.35	2IR0.35ISO...	2IL0.35ISO...	0.20	0.8	0.3	-	-	NVR..-2 (LH)
			0.4	2IR0.4ISO...	2IL0.4ISO...	0.23	0.8	0.4			
			0.45	2IR0.45ISO...	2IL0.45ISO...	0.26	0.8	0.4			
			0.5	2IR0.5ISO...	2IL0.5ISO...	0.29	0.6	0.4			
			0.6	2IR0.6ISO...	2IL0.6ISO...	0.35	0.6	0.6			
			0.7	2IR0.7ISO...	2IL0.7ISO...	0.40	0.6	0.6			
			0.75	2IR0.75ISO...	2IL0.75ISO...	0.43	0.6	0.6			
			0.8	2IR0.8ISO...	2IL0.8ISO...	0.46	0.6	0.6			
			1.0	2IR1.0ISO...	2IL1.0ISO...	0.58	0.6	0.7			
			1.25	2IR1.25ISO...	2IL1.25ISO...	0.72	0.8	0.9			
			1.5	2IR1.5ISO...	2IL1.5ISO...	0.87	0.8	1.0			
			1.75	2IR1.75ISO...	2IL1.75ISO...	1.01	0.9	1.1			
2.0	2IR2.0ISO...	2IL2.0ISO...	1.15	0.9	1.1						
2.5	2IR2.5ISO...	2IL2.5ISO...	1.44	0.8	1.1						
 SCB	1/4" SCB	11	0.5	2JIR0.5ISO...		0.29	1.2	0.5	-	-	NVR..-2
			0.75	2JIR0.75ISO...		0.43	1.2	0.5			
			0.8	2JIR0.8ISO...		0.46	1.2	0.5			
			1.0	2JIR1.0ISO...		0.58	0.7	0.8			
			1.25	2JIR1.25ISO...		0.72	0.7	0.8			
1.5	2JIR1.5ISO...		0.87	0.7	0.8						
	3/8"	16	0.35	3IR0.35ISO...	3IL0.35ISO...	0.20	0.8	0.3	Y13	YE3	AVR..-3 (LH)
			0.4	3IR0.4ISO...	3IL0.4ISO...	0.23	0.8	0.4			
			0.45	3IR0.45ISO...	3IL0.45ISO...	0.26	0.8	0.4			
			0.5	3IR0.5ISO...	3IL0.5ISO...	0.29	0.6	0.4			
			0.6	3IR0.6ISO...	3IL0.6ISO...	0.35	0.6	0.6			
			0.7	3IR0.7ISO...	3IL0.7ISO...	0.40	0.6	0.6			
			0.75	3IR0.75ISO...	3IL0.75ISO...	0.43	0.6	0.6			
			0.8	3IR0.8ISO...	3IL0.8ISO...	0.46	0.6	0.6			
			1.0	3IR1.0ISO...	3IL1.0ISO...	0.58	0.6	0.7			
			1.25	3IR1.25ISO...	3IL1.25ISO...	0.72	0.8	0.9			
			1.5	3IR1.5ISO...	3IL1.5ISO...	0.87	0.8	1.0			
			1.75	3IR1.75ISO...	3IL1.75ISO...	1.01	0.9	1.2			
			2.0	3IR2.0ISO...	3IL2.0ISO...	1.15	1.0	1.3			
			2.5	3IR2.5ISO...	3IL2.5ISO...	1.44	1.1	1.5			
3.0	3IR3.0ISO...	3IL3.0ISO...	1.73	1.1	1.5						
3.5	3IR3.5ISO...	3IL3.5ISO...	2.02	1.2	1.5						

continued on next page ▶



## ISO Metric (con't)

### Internal

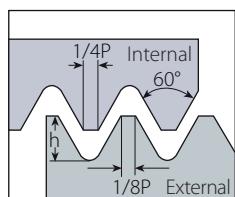

Defined by: R262 (DIN 13)  
Tolerance class: 6g/6H

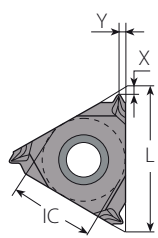

**SCB**  
Sintered  
Chipbreaker

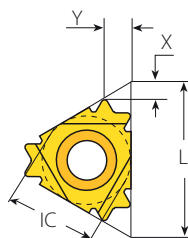

**V6**

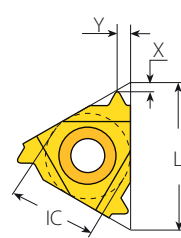

**Standard**

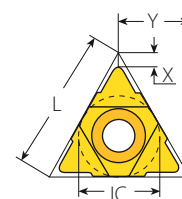

**U Style**

### Standard (con't)

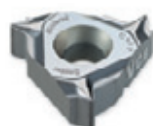

SCB



V6



Insert Size		Pitch	Ordering Code		Dimensions mm			Anvil		Toolholder	
IC	L mm	mm	RH	LH	h min	X	Y	RH	LH		
3/8"	SCB	16	1.0	3JIR1.0ISO...		0.58	0.7	0.8	Y13	-	AVR..-3
			1.25	3JIR1.25ISO...		0.72	0.7	0.8			
			1.5	3JIR1.5ISO...		0.87	0.7	0.8			
			1.75	3JIR1.75ISO...		1.01	1.1	1.5			
			2.0	3JIR2.0ISO...		1.15	1.1	1.5			
			2.5	3JIR2.5ISO...		1.44	1.1	1.5			
			3.0	3JIR3.0ISO...		1.73	1.1	1.5			
3.5	3JIR3.5ISO...		2.02	1.2	1.5						
3/8"	V6	16	0.5	3IR0.5ISO-6C...		0.29	2.1	1.7	Y13-6C	-	AVR..-3 NVRC..-3 206/
			0.75	3IR0.75ISO-6C...		0.43	2.0	1.8			
			0.8	3IR0.8ISO-6C...		0.46	1.9	1.8			
			1.0	3IR1.0ISO-6C...		0.58	1.9	1.6			
			1.25	3IR1.25ISO-6C...		0.72	1.7	2.0			
			1.5	3IR1.5ISO-6C...		0.87	1.5	2.1			
			1.75	3IR1.75ISO-6C...		1.01	1.6	2.4			
2.0	3IR2.0ISO-6C...		1.15	1.7	2.6						
1/2"	Standard	22	3.5	4IR3.5ISO...	4IL3.5ISO...	2.02	1.6	2.3	Y14	YE4	AVR..-4 (LH)
			4.0	4IR4.0ISO...	4IL4.0ISO...	2.31	1.6	2.3			
			4.5	4IR4.5ISO...	4IL4.5ISO...	2.60	1.6	2.4			
			5.0	4IR5.0ISO...	4IL5.0ISO...	2.89	1.6	2.3			
			6.0	4IR6.0ISO...	4IL6.0ISO...	3.46	1.8	2.5			
5/8"	Standard	27	4.5	5IR4.5ISO...	5IL4.5ISO...	2.60	1.6	2.4	Y15	YE5	AVR..-5 (LH)
			5.0	5IR5.0ISO...	5IL5.0ISO...	2.89	1.6	2.3			
			5.5	5IR5.5ISO...	5IL5.5ISO...	3.17	1.6	2.3			
			6.0	5IR6.0ISO...	5IL6.0ISO...	3.46	1.8	2.5			

### U Style



Insert Size		Pitch	Ordering Code	Dimensions mm			Anvil		Toolholder
IC	L mm	mm	RH+LH	h min.	X	Y	RH	LH	
1/2"U	22	5.5	4UI5.5ISO...	3.17	2.4	11.0	Y14U	YE4U	AVR..-4U (LH)
		6.0	4UI6.0ISO...	3.46	2.1	11.0			
5/8"U	27	8.0	5UI8.0ISO...	4.62	2.4	13.7	Y15U	YE5U	AVR..-5U (LH)

## ISO Metric (con't)

### Internal

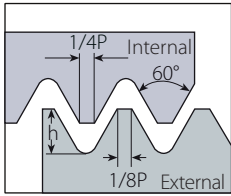

Defined by: R262 (DIN 13)  
Tolerance class: 6g/6H

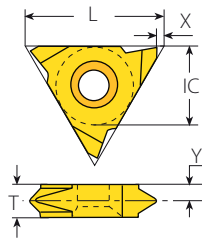

V Style

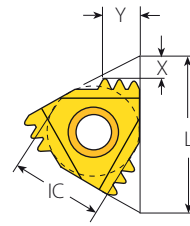

M+ Style

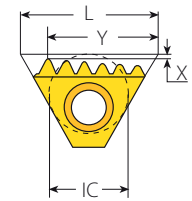

T+ Style

### V Style



Insert Size		Pitch	Ordering Code			Dimensions mm			Toolholder
IC	L mm	mm	RH	LH	h min	X	Y	T	
5/8"V	27	6.0	5VIR6.0ISO...	5VIL6.0ISO...	3.46	1.0	3.3	6	NVR..-5V (LH)
		8.0	5VIR8.0ISO...	5VIL8.0ISO...	4.62	1.0	4.3	8	
		10.0	5VIR10.0ISO...	5VIL10.0ISO...	5.77	1.0	5.2	10	

### M+ Style



Insert Size		Pitch	Teeth	Ordering Code	Dimensions mm			Anvil	Toolholder
IC	L mm	mm		RH	h min	X	Y	RH	
3/8"	16	1.0	3	3IR1.0ISO3M+...	0.58	1.7	2.6	Y13M	AVR..-3
		1.5	2	3IR1.5ISO2M+...	0.87	1.6	2.4		
		2.0	2	3IR2.0ISO2M+...	1.15	2.0	3.1		
1/2"	22	1.5	3	4IR1.5ISO3M+...	0.87	2.5	3.8	Y14M	AVR..-4
		2.0	2	4IR2.0ISO2M+...	1.15	2.0	3.1		
		2.0	3	4IR2.0ISO3M+...	1.15	3.2	5.1		
5/8"	27	3.0	2	5IR3.0ISO2M+...	1.73	3.0	4.7	Y15M	AVR..-5M

### T+ Style



Insert Size		Pitch	Teeth	Ordering Code	Dimensions mm			Anvil	Toolholder
IC	L mm	mm		RH	h min	X	Y	RH	
1/2"	22	1.5	8	4IR1.5ISO8T+...	0.87	0.2	12.4	Y4T	AVR..-4T
		2.0	8	4IR2.0ISO8T+...	1.15	0.2	17.5		

# ISO Metric (con't)



## Internal

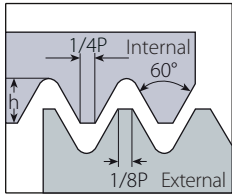

Defined by: R262 (DIN 13)  
Tolerance class: 6g/6H

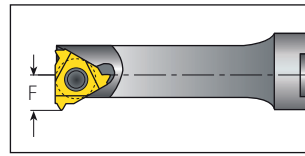
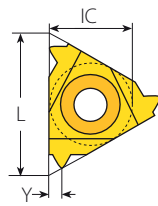

Mini-3

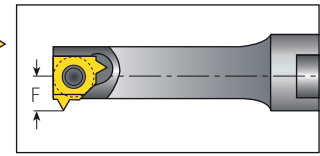
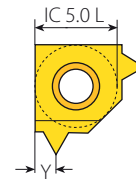

Mini-L

## Mini-3



Insert Size		Pitch	Ordering Code	Dimensions mm			Min. Bore dia.	Toolholder
IC	L mm	mm	RH	h min	Y	F	mm	
4.0	6	0.25	4.0KIR0.25ISO...	0.15	0.25	3.3	5.95	.NVR5-4.0K
		0.5	4.0KIR0.5ISO...	0.29	0.5	3.4	6.05	
		0.75	4.0KIR0.75ISO...	0.43	0.5	3.5	6.15	
		1.0	4.0KIR1.0ISO...	0.58	0.7	3.6	6.25	
		1.25	4.0KIR1.25ISO...	0.72	0.6	3.7	6.35	
6.0	10	0.5	6.0IR0.5ISO...	0.29	0.6	4.4	9.3	.NVR1...-6.0
		0.75	6.0IR0.75ISO...	0.43	0.6	4.6	9.5	
		1.0	6.0IR1.0ISO...	0.58	0.7	4.7	9.6	
		1.25	6.0IR1.25ISO...	0.72	0.9	4.9	9.8	
		1.5	6.0IR1.5ISO...	0.87	1.0	5.0	9.9	
		1.75	6.0IR1.75ISO...	1.01	1.05	5.2	10.0	
		2.0	6.0IR2.0ISO...	1.15	1.05	5.3	10.0	

## Mini-L



Insert Size		Pitch	Ordering Code	Dimensions mm			Min. Bore dia.	Toolholder
IC mm		mm	RH	h min	Y	F	mm	
5.0L		0.35	5LIR0.35ISO...	0.20	0.3	3.75	7.3	.NVR10.-5L
		0.5	5LIR0.5ISO...	0.29	0.4	3.75	7.3	
		0.75	5LIR0.75ISO...	0.43	0.6	3.91	7.5	
		1.0	5LIR1.0ISO...	0.58	0.7	4.06	7.7	
		1.25	5LIR1.25ISO...	0.72	0.9	4.21	7.8	
		1.5	5LIR1.5ISO...	0.87	1.0	4.35	7.9	
		1.75	5LIR1.75ISO...	1.01	1.05	4.51	8.0	
		2.0	5LIR2.0ISO...	1.15	1.05	4.65	8.0	

## ISO Metric (con't)



### Internal

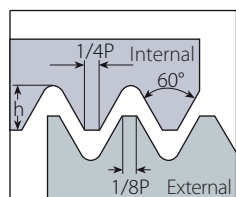

Defined by: R262 (DIN 13)  
Tolerance class: 6g/6H

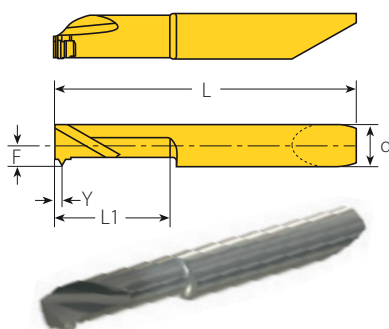

RH-Single Ended

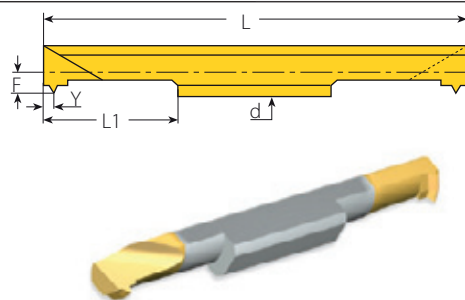

RH-Double Ended

### Micro - Double Ended

Thread	Insert dia.		Ordering Code	Dimensions mm					Min. Bore dia.		Toolholder
	d mm	mm		RH/LH	L1	L	F	Y	h min	mm	
M4 x 0.3	3.0	0.3	3.0SIR0.3ISO...	16	50	1.31	0.20	0.17	3.2	SMC...-3.0	
M4 x 0.4		0.4	3.0SIR0.4ISO...	16	50	1.31	0.35	0.22	3.2		
M4 x 0.5		0.5	3.0SIR0.5ISO...	16	50	1.31	0.40	0.29	3.2		
M4 x 0.6		0.6	3.0SIR0.6ISO...	16	50	1.34	0.60	0.35	3.2		
M4.5 x 0.7		0.7	3.0SIR0.7ISO...	16	50	1.43	0.60	0.40	3.3		
M4.5 x 0.75	0.75	3.0SIR0.75ISO...	16	50	1.45	0.60	0.43	3.3	SMC...-4.0		
M5 x 0.8	0.8	3.0SIR0.8ISO...	16	50	1.46	0.60	0.46	3.3			
M5 x 0.4	4.0	0.4	4.0SIR0.4ISO...	16	50	1.65	0.35	0.22		4.0	
M5 x 0.5		0.5	4.0SIR0.5ISO...	16	50	1.65	0.40	0.29		4.0	
M5 x 0.6		0.6	4.0SIR0.6ISO...	16	50	1.68	0.60	0.35		4.0	
M5 x 0.7		0.7	4.0SIR0.7ISO...	16	50	1.77	0.60	0.40	4.1		
M5.5 x 0.75		0.75	4.0SIR0.75ISO...	16	50	1.81	0.60	0.43	4.2		
M5.5 x 0.8	0.8	4.0SIR0.8ISO...	16	50	1.80	0.60	0.46	4.2	SMC...-6.0		
M6 x 1	1.0	4.0SIR1.0ISO...	16	50	1.96	0.90	0.58	4.3			
M6 x 0.5	6.0	0.5	6.0SIR0.5ISO...	16	50	1.90	0.60	0.29		5.4	
M6.5 x 0.75		0.75	6.0SIR0.75ISO...	16	50	2.06	0.60	0.43		5.6	
M7 x 1		1.0	6.0SIR1.0ISO...	16	50	2.21	0.70	0.58		5.7	
M8 x 1.25		1.25	6.0SIR1.25ISO...	16	50	2.36	0.90	0.72	5.9		
M10.5 x 1.5		1.5	6.0SIR1.5ISO...	16	50	2.50	1.00	0.87	6.0		

Left Handed Tool Supplied by Request. (Example: 3.0SIL0.3ISO...)

### Micro - Single Ended



Thread	Insert dia.		Ordering Code	Dimensions mm					Min. Bore dia.		Toolholder
	d mm	mm		RH/LH	L1	L	F	Y	h min	mm	
M4x0.5	4.0	0.5	M429TH 0.50ISO L16R/L	16	33	0.9	0.4	0.29	3.4	MHC...-4	
M5x0.5		0.5	M439TH 0.50ISO L16R/L	16	33	1.9	0.4	0.29	4.4		
M4x0.7		0.7	M429TH 0.70ISO L16R/L	16	33	0.9	0.5	0.41	3.2		
M5x0.8		0.8	M429TH 0.80ISO L16R/L	16	33	0.9	0.6	0.46	4.0		
M6x1		1.0	M439TH 1.00ISO L16R/L	16	33	1.9	0.7	0.58	4.8		
M5.5x0.5	5.0	0.5	M542TH 0.50ISO L16R/L	16	41	1.7	0.4	0.29	4.9	MHC...-5	
M5.5x0.75		0.75	M542TH 0.75ISO L16R/L	16	41	1.7	0.6	0.43	4.6		
M7x1		1.0	M549TH 1.00ISO L16R/L	16	41	2.4	0.7	0.58	5.8		
M6x0.5		0.5	M649TH 0.50ISO L16R/L	16	42	1.9	0.4	0.29	5.4		
M6.5x0.75		0.75	M649TH 0.75ISO L16R/L	16	42	1.9	0.6	0.43	5.6		
M7.5x1	6.0	1.0	M659TH 1.00ISO L16R/L	16	42	2.9	0.7	0.58	6.3	MHC...-6	
M8x1.25		1.25	M659TH 1.25ISO L16R/L	16	42	2.9	0.9	0.72	6.5		
M10x1.5		1.5	M659TH 1.50ISO L16R/L	16	42	2.9	1.0	0.87	8.3		

Left Handed Tool Supplied by Request. (Example: M429TH 0.50ISO L16L)

# American UN - UNC, UNF, UNEF, UNS

## External

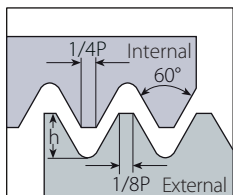

Defined by: ANSI B1.1:74  
Tolerance class: 2A/2B

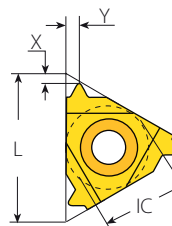

Standard

## Standard

Insert Size		Pitch	Ordering Code		Dimensions mm			Anvil		Toolholder
IC	L mm	tpi	RH	LH	h min	X	Y	RH	LH	
1/4"	11	72	2ER72UN...	2EL72UN...	0.22	0.8	0.4	-	-	NL ..-2 (LH)
		64	2ER64UN...	2EL64UN...	0.24	0.8	0.4			
		56	2ER56UN...	2EL56UN...	0.28	0.7	0.4			
		48	2ER48UN...	2EL48UN...	0.32	0.6	0.6			
		44	2ER44UN...	2EL44UN...	0.35	0.6	0.6			
		40	2ER40UN...	2EL40UN...	0.39	0.6	0.6			
		36	2ER36UN...	2EL36UN...	0.43	0.6	0.6			
		32	2ER32UN...	2EL32UN...	0.49	0.6	0.6			
		28	2ER28UN...	2EL28UN...	0.56	0.6	0.7			
		27	2ER27UN...	2EL27UN...	0.58	0.7	0.8			
		24	2ER24UN...	2EL24UN...	0.65	0.7	0.8			
		20	2ER20UN...	2EL20UN...	0.78	0.8	0.9			
		18	2ER18UN...	2EL18UN...	0.87	0.8	1.0			
		16	2ER16UN...	2EL16UN...	0.97	0.9	1.1			
		14	2ER14UN...	2EL14UN...	1.11	0.9	1.1			
		3/8"	16	80	3ER80UN...	3EL80UN...	0.18			
72	3ER72UN...			3EL72UN...	0.22	0.8	0.4			
64	3ER64UN...			3EL64UN...	0.24	0.8	0.4			
56	3ER56UN...			3EL56UN...	0.28	0.7	0.4			
48	3ER48UN...			3EL48UN...	0.32	0.6	0.6			
44	3ER44UN...			3EL44UN...	0.35	0.6	0.6			
40	3ER40UN...			3EL40UN...	0.39	0.6	0.6			
36	3ER36UN...			3EL36UN...	0.43	0.6	0.6			
32	3ER32UN...			3EL32UN...	0.49	0.6	0.6			
28	3ER28UN...			3EL28UN...	0.56	0.6	0.7			
27	3ER27UN...			3EL27UN...	0.58	0.7	0.8			
24	3ER24UN...			3EL24UN...	0.65	0.7	0.8			
20	3ER20UN...			3EL20UN...	0.78	0.8	0.9			
18	3ER18UN...			3EL18UN...	0.87	0.8	1.0			
16	3ER16UN...			3EL16UN...	0.97	0.9	1.1			
14	3ER14UN...			3EL14UN...	1.11	1.0	1.2			
13	3ER13UN...	3EL13UN...	1.20	1.0	1.3					
12	3ER12UN...	3EL12UN...	1.30	1.1	1.4					
11.5	3ER11.5UN...	3EL11.5UN...	1.35	1.1	1.5					
11	3ER11UN...	3EL11UN...	1.42	1.1	1.5					
10	3ER10UN...	3EL10UN...	1.56	1.1	1.5					
9	3ER9UN...	3EL9UN...	1.73	1.2	1.7					
8	3ER8UN...	3EL8UN...	1.95	1.2	1.6					



continued on next page ▶

# American UN - UNC, UNF, UNEF, UNS (con't)

## External

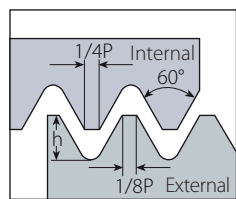

Defined by: ANSI B1.1:74  
Tolerance class: 2A/2B

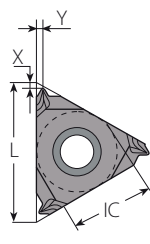

**SCB**  
Sintered  
Chipbreaker

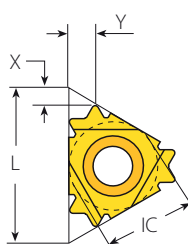

**V6**

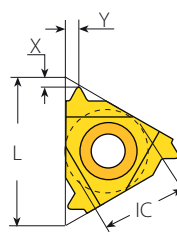



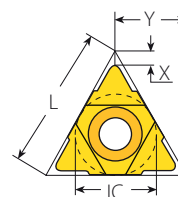

**Standard**



**U Style**

## Standard (con't)

Insert Size		Pitch	Ordering Code		Dimensions mm			Anvil		Toolholder	
IC	L mm	tpi	RH	LH	h min	X	Y	RH	LH		
 SCB	3/8"	16	36	3JER36UN...		0.43	1.2	0.5	YE3	-	AL..-3
			32	3JER32UN...		0.49	1.2	0.5			
			28	3JER28UN...		0.56	0.7	0.8			
			24	3JER24UN...		0.65	0.7	0.8			
			20	3JER20UN...		0.78	0.7	0.8			
			18	3JER18UN...		0.87	0.7	0.8			
			16	3JER16UN...		0.97	0.8	0.8			
			14	3JER14UN...		1.11	1.2	1.5			
			13	3JER13UN...		1.20	1.2	1.5			
			12	3JER12UN...		1.30	1.3	1.5			
			10	3JER10UN...		1.56	1.2	1.5			
			9	3JER9UN...		1.73	1.2	1.5			
8	3JER8UN...		1.95	1.3	1.5						
 V6	3/8"	16	32	3ER32UN-6C...		0.49	2.0	1.9	YE3-6C	-	AL..-3
			28	3ER28UN-6C...		0.56	2.0	2.0			
			24	3ER24UN-6C...		0.65	1.9	2.0			
			20	3ER20UN-6C...		0.78	1.8	2.1			
			18	3ER18UN-6C...		0.87	1.9	2.3			
			16	3ER16UN-6C...		0.97	1.8	2.4			
			14	3ER14UN-6C...		1.11	1.8	2.7			
			13	3ER13UN-6C...		1.20	1.9	2.9			
 Standard	1/2"	22	7	4ER7UN...	4EL7UN...	2.22	1.6	2.3	YE4	YI4	AL..-4 (LH)
			6	4ER6UN...	4EL6UN...	2.60	1.6	2.3			
			5	4ER5UN...	4EL5UN...	3.12	1.7	2.5			
 U Style	5/8"	27	4.5	5ER4.5UN...	5EL4.5UN...	3.46	1.9	2.7	YE5	YI5	AL..-5 (LH)
			4	5ER4UN...	5EL4UN...	3.89	2.1	3.0			

## U Style



Insert Size		Pitch	Ordering Code		Dimensions mm			Anvil		Toolholder
IC	L mm	tpi	RH+LH	h min	X	Y	RH	LH		
1/2"U	22	4.5	4UE4.5UN...	3.46	2.0	11.0	YE4U	YI4U	AL..-4U (LH)	
		4	4UE4UN...	3.89	2.0	11.0				
5/8"U	27	3	5UE3UN...	5.19	2.5	13.7	YE5U	YI5U	AL..-5U (LH)	

## American UN - UNC, UNF, UNEF, UNS (con't)

### External

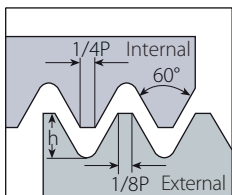

Defined by: ANSI B1.1:74  
Tolerance class: 2A/2B

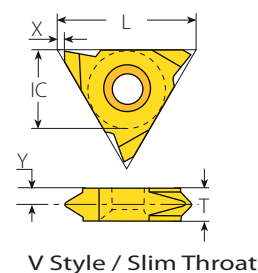

V Style / Slim Throat

### Slim Throat

Insert Size		Pitch	Ordering Code		Dimensions mm				Toolholder
IC	L mm	tpi	RH	LH	h min	X	Y	T	
1/4"V	11	20	2VER20UN...	2VEL20UN...	0.78	0.69	2.3	3.2	NL...-2V (LH)
		18	2VER18UN...	2VEL18UN...	0.87	0.69	2.2	3.2	
		16	2VER16UN...	2VEL16UN...	0.97	0.69	2.2	3.2	
		14	2VER14UN...	2VEL14UN...	1.11	0.69	2.0	3.2	
		12	2VER12UN...	2VEL12UN...	1.30	0.69	1.8	3.2	
3/8"V	16	32	3VER32UN...	3VEL32UN...	0.48	1.1	3.0	3.6	NL...-3V (LH)
		28	3VER28UN...	3VEL28UN...	0.56	1.1	3.0	3.6	
		24	3VER24UN...	3VEL24UN...	0.65	1.1	2.9	3.6	
		20	3VER20UN...	3VEL20UN...	0.78	1.1	2.7	3.6	
		18	3VER18UN...	3VEL18UN...	0.87	1.1	2.6	3.6	
		16	3VER16UN...	3VEL16UN...	0.97	1.1	2.55	3.6	
		14	3VER14UN...	3VEL14UN...	1.11	1.1	2.4	3.6	
		12	3VER12UN...	3VEL12UN...	1.30	1.1	2.2	3.6	
10	3VER10UN...	3VEL10UN...	1.56	1.1	2.1	3.6			
8	3VER8UN...	3VEL8UN...	1.95	1.1	2.0	3.6			
1/2"V	22	7	4VER7UN...	4VEL7UN...	2.22	1.1	2.5	4.8	NL...-4V (LH)



### V Style

Insert Size		Pitch	Ordering Code		Dimensions mm				Toolholder
IC	L mm	tpi	RH	LH	h min	X	Y	T	
5/8"V	27	4	5VER4UN...	5VEL4UN...	3.89	1.0	3.3	6	NL...-5V-6 (LH)
		3	5VER3UN...	5VEL3UN...	5.19	1.0	4.3	8	NL...-5V-8 (LH)



# American UN - UNC, UNF, UNEF, UNS (con't)

## External

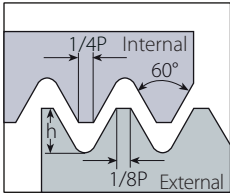

Defined by: ANSI B1.1:74  
Tolerance class: 2A/2B

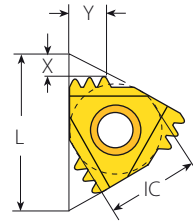

M+ Style

## M+ Style



Insert Size		Pitch	Teeth	Ordering Code	Dimensions mm			Anvil	
IC	L mm	tpi		RH	h min	X	Y	RH	Toolholder
3/8"	16	20	3	3ER20UN3M+...	0.78	2.2	3.3	YE3M	AL..-3
		18	2	3ER18UN2M+...	0.87	1.5	2.2		
		18	3	3ER18UN3M+...	0.87	2.3	3.6		
		16	2	3ER16UN2M+...	0.97	1.7	2.5		
		14	2	3ER14UN2M+...	1.11	1.9	2.8		
		12	2	3ER12UN2M+...	1.3	2.2	3.3		
1/2"	22	16	3	4ER16UN3M+...	0.97	2.6	4.1	YE4M	AL..-4
		14	2	4ER14UN2M+...	1.11	1.9	2.8		
		12	2	4ER12UN2M+...	1.3	2.2	3.3		
		12	3	4ER12UN3M+...	1.3	3.4	5.4		
		11	2	4ER11UN2M+...	1.42	2.3	3.6		
5/8"	27	8	2	5ER8UN2M+...	1.95	3.1	4.9	YE5M	AL..-5M



# American UN - UNC, UNF, UNEF, UNS (con't)

## Internal

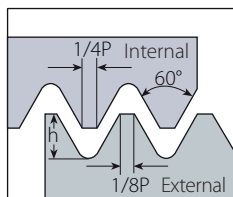

Defined by: ANSI B1.1:74  
Tolerance class: 2A/2B

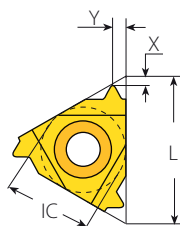

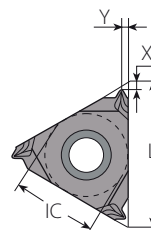

Standard

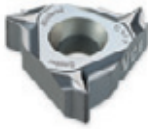

SCB  
Sintered  
Chipbreaker

## Standard (con't)

Insert Size		Pitch	Ordering Code		Dimensions mm			Anvil		Toolholder	
IC	L mm	tpi	RH	LH	h min	X	Y	RH	LH		
	1/4"	11	72	2IR72UN...	2IL72UN...	0.20	0.8	0.3	-	-	NVR..-2 (LH)
			64	2IR64UN...	2IL64UN...	0.23	0.8	0.4			
			56	2IR56UN...	2IL56UN...	0.26	0.7	0.4			
			48	2IR48UN...	2IL48UN...	0.31	0.6	0.6			
			44	2IR44UN...	2IL44UN...	0.33	0.6	0.6			
			40	2IR40UN...	2IL40UN...	0.37	0.6	0.6			
			36	2IR36UN...	2IL36UN...	0.41	0.6	0.6			
			32	2IR32UN...	2IL32UN...	0.46	0.6	0.6			
			28	2IR28UN...	2IL28UN...	0.52	0.6	0.7			
			27	2IR27UN...	2IL27UN...	0.54	0.7	0.8			
			24	2IR24UN...	2IL24UN...	0.61	0.7	0.8			
			20	2IR20UN...	2IL20UN...	0.73	0.8	0.9			
			18	2IR18UN...	2IL18UN...	0.81	0.8	1.0			
 SCB	1/4" SCB	11	36	2JIR36UN...		0.41	1.1	0.5	-	-	NVR..-2
			32	2JIR32UN...		0.46	1.2	0.5			
			28	2JIR28UN...		0.52	0.6	0.8			
			24	2JIR24UN...		0.61	0.7	0.8			
			20	2JIR20UN...		0.73	0.6	0.8			
			18	2JIR18UN...		0.81	0.6	0.8			
	3/8"	16	72	3IR72UN...	3IL72UN...	0.20	0.8	0.3	Y13	YE3	AVR..-3 (LH)
			64	3IR64UN...	3IL64UN...	0.23	0.8	0.4			
			56	3IR56UN...	3IL56UN...	0.26	0.7	0.4			
			48	3IR48UN...	3IL48UN...	0.31	0.6	0.6			
			44	3IR44UN...	3IL44UN...	0.33	0.6	0.6			
			40	3IR40UN...	3IL40UN...	0.37	0.6	0.6			
			36	3IR36UN...	3IL36UN...	0.41	0.6	0.6			
			32	3IR32UN...	3IL32UN...	0.51	0.6	0.6			
			28	3IR28UN...	3IL28UN...	0.52	0.6	0.7			
			27	3IR27UN...	3IL27UN...	0.54	0.7	0.8			

continued on next page ▶

# American UN - UNC, UNF, UNEF, UNS (con't)

## Internal

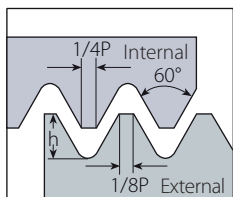

Defined by: ANSI B1.1:74  
Tolerance class: 2A/2B

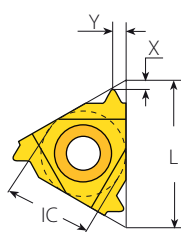

Standard

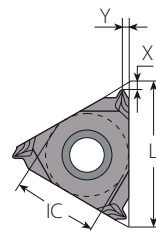



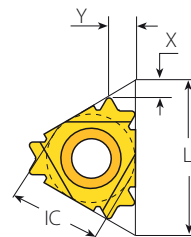

SCB  
Sintered  
Chipbreaker



V6

## Standard (con't)

Insert Size		Pitch	Ordering Code		Dimensions mm			Anvil		Toolholder	
IC	L mm	tpi	RH	LH	h min	X	Y	RH	LH		
	3/8"	16	24	3IR24UN...	3IL24UN...	0.61	0.7	0.8	YI3	YE3	AVR.-3 (LH)
			20	3IR20UN...	3IL20UN...	0.73	0.8	0.9			
			18	3IR18UN...	3IL18UN...	0.81	0.8	1.0			
			16	3IR16UN...	3IL16UN...	0.92	0.9	1.1			
			14	3IR14UN...	3IL14UN...	1.05	0.9	1.2			
			13	3IR13UN...	3IL13UN...	1.13	1.0	1.3			
			12	3IR12UN...	3IL12UN...	1.22	1.1	1.4			
			11.5	3IR11.5UN...	3IL11.5UN...	1.28	1.1	1.5			
			11	3IR11UN...	3IL11UN...	1.33	1.1	1.5			
			10	3IR10UN...	3IL10UN...	1.47	1.1	1.5			
			9	3IR9UN...	3IL9UN...	1.63	1.2	1.7			
8	3IR8UN...	3IL8UN...	1.83	1.1	1.5						
 SCB	3/8"	16	28	3JIR28UN...		0.52	0.6	0.8	YI3	-	AVR.-3
			24	3JIR24UN...		0.61	0.7	0.8			
			20	3JIR20UN...		0.73	0.6	0.8			
			18	3JIR18UN...		0.81	0.6	0.8			
			16	3JIR16UN...		0.92	0.7	0.8			
			14	3JIR14UN...		1.05	1.1	1.5			
			13	3JIR13UN...		1.13	1.1	1.5			
			12	3JIR12UN...		1.22	1.1	1.5			
			10	3JIR10UN...		1.47	1.1	1.5			
9	3JIR9UN...		1.63	1.0	1.5						
8	3JIR8UN...		1.83	1.1	1.5						
 V6	3/8"	16	32	3IR32UN-6C...		0.51	2.0	1.8	YI3-6C	-	AVR.-3 NVRC.-3 206/...
			28	3IR28UN-6C...		0.52	1.9	1.9			
			24	3IR24UN-6C...		0.61	1.9	1.9			
			20	3IR20UN-6C...		0.73	1.8	2.1			
			18	3IR18UN-6C...		0.81	1.7	2.1			
			16	3IR16UN-6C...		0.92	1.6	2.2			
			14	3IR14UN-6C...		1.05	1.7	2.5			
			13	3IR13UN-6C...		1.13	1.8	2.7			
12	3IR12UN-6C...		1.22	1.6	2.5						
	1/2"	22	7	4IR7UN...	4IL7UN...	2.09	1.6	2.3	YI4	YE4	AVR.-4 (LH)
			6	4IR6UN...	4IL6UN...	2.44	1.6	2.3			
			5	4IR5UN...	4IL5UN...	2.93	1.6	2.3			
5/8"	27	4.5	5IR4.5UN...	5IL4.5UN...	3.26	1.7	2.4	YI5	YE5	AVR.-5 (LH)	
		4	5IR4UN...	5IL4UN...	3.67	1.8	2.7				

# American UNC

## Internal

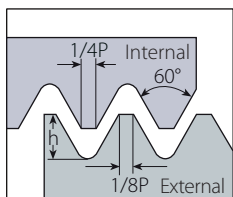

Defined by: ANSI B1.1:74  
Tolerance class: 2A/2B

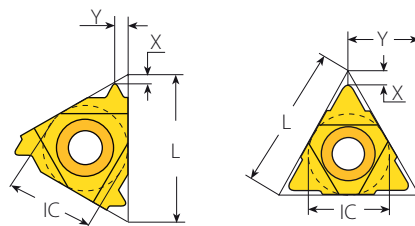

Standard

U+ Style

## Coarse Pitch



Thread	Insert Size		Ordering Code	Dimensions mm				Toolholder	Min Bore dia. mm
	IC	L mm		RH/LH	h min	X	Y		
1/2 x 13UN	6.0	10	6.0IR13UN...158/001		1.13	0.8	0.9	BNVR10S-6.0	10.6
9/16 x 12UN	1/4"	11	2IR12UN...158/002		1.22	0.9	1.0	NVRC10-2 156/001	12.0
5/8 x 11UN	1/4"U		2UIR11UN...158/003		1.33	1.2	5.5	NVRC11-2U 156/002	13.4
3/4 x 10UN	3/8"	16	3IR10UN...		1.47	1.1	1.5	NVRC13-3 156/016	16.3
7/8 x 9UN			3IR9UN...		1.63	1.2	1.7	NVRC13-3 156/016	19.2
1 x 8UN			3IR8UN...		1.83	1.1	1.5	NVRC16-3	22.0
1 1/8 x 7UN	1/2"	22	4IR7UN...		2.09	1.6	2.3	NVRC20-4	24.6
1 1/4 x 7UN			4IR7UN...		2.09	1.6	2.3	NVRC20-4	27.8
1 3/8 x 6UN			4IR6UN...		2.44	1.6	2.3	NVRC20-4	30.3

Left Handed Tool Supplied by Request.  
U Type Inserts Can Be Used for Both LH and RH Applications.

## American UN - UNC, UNF, UNEF, UNS (con't)

### Internal

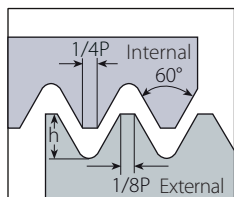

Defined by: ANSI B1.1:74  
Tolerance class: 2A/2B

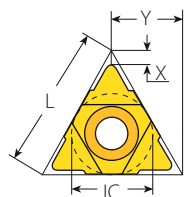

U Style

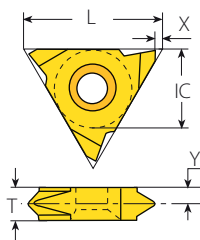

V Style

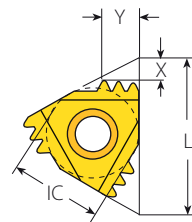

M+ Style

### U Style



Insert Size		Pitch	Ordering Code	Dimensions mm			Anvil		Toolholder
IC	L mm	tpi	RH+LH	h min	X	Y	RH	LH	
1/2"U	22	4.5	4UI4.5UN...	3.26	2.4	11.0	YI4U	YE4U	AVR...-4U (LH)
		4	4UI4UN...	3.67	2.4	11.0			
5/8"U	27	3	5UI3UN...	4.89	2.7	13.7	YI5U	YE5U	AVR...-5U (LH)

### V Style



Insert Size		Pitch	Ordering Code		Dimensions mm				Toolholder
IC	L mm	tpi	RH	LH	h min	X	Y	T	
5/8"V	27	4	5VIR4UN...	5VIL4UN...	3.67	1.0	3.3	6	NVR...-5V (LH)
		3	5VIR3UN...	5VIL3UN...	4.89	1.0	4.3	8	

### M+ Style

**Multi**plus



Insert Size		Pitch	Teeth	Ordering Code	Dimensions mm			Anvil	Toolholder
IC	L mm	tpi		RH	h min	X	Y	RH	
3/8"	16	12	2	3IR12UN2M+...	1.22	2.2	3.3	YI3M	AVR...-3
		14	2	3IR14UN2M+...	1.05	1.9	2.8		
		16	2	3IR16UN2M+...	0.92	1.7	2.5		
1/2"	22	16	3	4IR16UN3M+...	0.92	2.6	4.1	YI4M	AVR...-4
		14	2	4IR14UN2M+...	1.05	1.9	2.8		
		12	2	4IR12UN2M+...	1.22	2.2	3.3		
		12	3	4IR12UN3M+...	1.22	3.4	5.4		
5/8"	27	8	2	5IR8UN2M+...	1.83	3.1	4.9	YI5M	AVR...-5M

# American UN - UNC, UNF, UNEF, UNS (con't)



## Internal

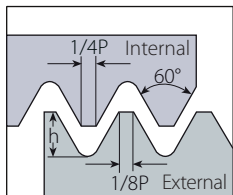

Defined by: ANSI B1.1:74  
Tolerance class: 2A/2B

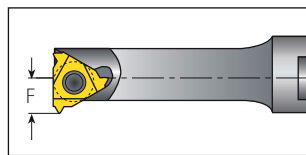
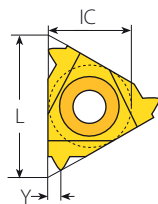

Mini-3

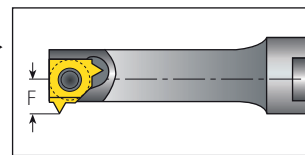
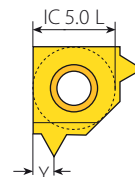

Mini-L

## Mini-3



Insert Size		Pitch	Ordering Code	Dimensions mm			Min. Bore dia.	Toolholder
IC	L mm	tpi	RH	h min	Y	F	mm	
4.0	6	32	4.0KIR32UN...	0.46	0.5	3.50	6.15	.NVR.5-4.0K
		28	4.0KIR28UN...	0.52	0.6	3.50	6.15	
		24	4.0KIR24UN...	0.61	0.6	3.60	6.25	
		20	4.0KIR20UN...	0.73	0.6	3.70	6.35	
		18	4.0KIR18UN...	0.81	0.7	3.70	6.35	
6.0	10	40	6.0IR40UN...	0.37	0.6	4.50	9.5	.NVR1.-6.0
		32	6.0IR32UN...	0.46	0.6	4.60	9.5	
		28	6.0IR28UN...	0.52	0.65	4.70	9.6	
		24	6.0IR24UN...	0.61	0.75	4.80	9.7	
		20	6.0IR20UN...	0.73	0.9	4.90	9.8	
		18	6.0IR18UN...	0.81	1.0	5.00	9.9	
		16	6.0IR16UN...	0.92	1.05	5.10	10.0	
14	6.0IR14UN...	1.05	1.05	5.20	10.0			

## Mini-L



Insert Size		Pitch	Ordering Code	Dimensions mm			Min. Bore dia.	Toolholder
IC mm	tpi	RH	h min	Y	F	mm		
5.0L	32	5LIR32UN...	0.46	0.6	3.92	7.5	.NVR10.-5L	
	28	5LIR28UN...	0.52	0.65	3.99	7.6		
	24	5LIR24UN...	0.61	0.75	4.09	7.7		
	20	5LIR20UN...	0.73	0.9	4.21	7.8		
	18	5LIR18UN...	0.81	1.0	4.30	7.9		
	16	5LIR16UN...	0.92	1.05	4.41	8.0		
	14	5LIR14UN...	1.05	1.05	4.54	8.0		

## American UN - UNC, UNF, UNEF, UNS (con't)



### Internal

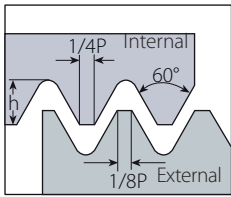

Defined by: ANSI B1.1:74  
Tolerance class: 2A/2B

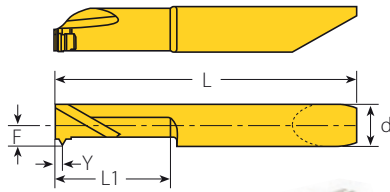

RH-Single Ended

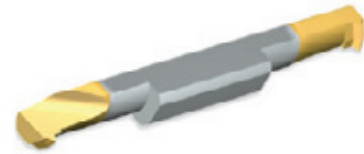
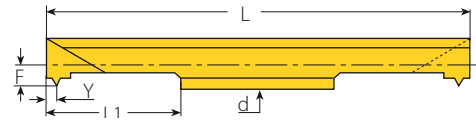

RH-Double Ended

### Micro - Double Ended

Thread	Insert dia.		Ordering Code	Dimensions mm					Min. Bore dia.		Toolholder
	d mm	mm		RH/LH	L1	L	F	Y	h min	mm	
10-40UNS	3.0	40	3.0SIR40UN...	16	50	1.35	0.60	0.37	3.2	SMC...-3.0	
8-36UNF		36	3.0SIR36UN...	16	50	1.46	0.60	0.41	3.2		
8-32UNF		32	3.0SIR32UN...	16	50	1.40	0.60	0.46	3.3		
10-40UNS	4.0	40	4.0SIR40UN...	16	50	1.65	0.60	0.37	4.0	SMC...-4.0	
10-36UNS		36	4.0SIR36UN...	16	50	1.70	0.60	0.41	4.1		
12-32UNEF		32	4.0SIR32UN...	16	50	1.76	0.60	0.46	4.1		
12-28UNF		28	4.0SIR28UN...	16	50	1.83	0.65	0.52	4.2		
1/4"-27UNS	6.0	27	4.0SIR27UN...	16	50	1.85	0.75	0.54	4.2	SMC...-6.0	
12-24UNC		24	4.0SIR24UN...	16	50	1.93	0.75	0.61	4.3		
1/4"-20UNC		20	4.0SIR20UN...	16	50	2.03	0.76	0.73	4.3		
1/4"-32UNEF		32	6.0SIR32UN...	16	50	2.01	0.60	0.46	5.5		
5/16"-28UN		28	6.0SIR28UN...	16	50	2.08	0.65	0.52	5.6		
5/16"-27UNS	6.0	27	6.0SIR27UN...	16	50	2.10	0.75	0.54	5.6	SMC...-6.0	
5/16"-24UNF		24	6.0SIR24UN...	16	50	2.18	0.75	0.61	5.7		
5/16"-20UN		20	6.0SIR20UN...	16	50	2.30	0.90	0.73	5.8		
5/16"-18UNC	6.0	18	6.0SIR18UN...	16	50	2.39	1.00	0.81	5.9	SMC...-6.0	
3/8"-16UNC		16	6.0SIR16UN...	16	50	2.50	1.05	0.92	6.0		

Left Handed Tool Supplied by Request. (Example: 6.0SIL16UN...)

### Micro - Single Ended



Thread	Insert dia.		Ordering Code	Dimensions mm					Min. Bore dia.		Toolholder
	d mm	mm		RH/LH	L1	L	F	Y	h min	mm	
8-32UNC	4.0	32	M429TH 32UN L16R/L	16	33	0.9	0.6	0.46	3.3	MHC...-4	
10-28UNS		28	M429TH 28UN L16R/L	16	33	0.9	0.65	0.52	3.6		
1/4"-27UNS	5.0	27	M549TH 27UN L16R/L	16	41	2.4	0.75	0.54	5.3	MHC...-5	
1/4"-24UNS		24	M542TH 24UN L16R/L	16	41	1.7	0.75	0.61	5.1		
1/4"-20UNC		20	M542TH 20UN L16R/L	16	41	1.7	0.9	0.73	4.6		
5/16"-18UNC	6.0	18	M659TH 18UN L16R/L	16	42	2.9	1.05	0.81	6.3	MHC...-6	
3/8"-16UNC		16	M659TH 16UN L16R/L	16	42	2.9	1.0	0.92	7.7		

Left Handed Tool Supplied by Request. (Example: M429TH 32UN L16L)

# Whitworth - BSW, BSP, BSF, BSB

## External

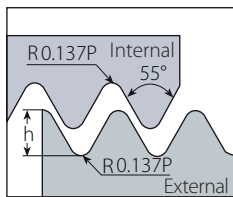

Defined by: B.S.84:1956, DIN 259, ISO228/1:1982  
Tolerance class: Medium class A

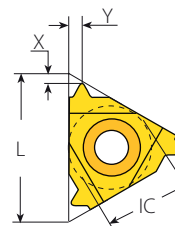

Standard

## Standard

Insert Size		Pitch	Ordering Code		Dimensions mm			Anvil		Toolholder
IC	L mm	tpi	RH	LH	h min	X	Y	RH	LH	
1/4"	11	72	2ER72W...	2EL72W...	0.23	0.7	0.4	-	-	NL...-2 (LH)
		60	2ER60W...	2EL60W...	0.27	0.7	0.4			
		56	2ER56W...	2EL56W...	0.29	0.7	0.4			
		48	2ER48W...	2EL48W...	0.34	0.6	0.6			
		40	2ER40W...	2EL40W...	0.41	0.6	0.6			
		36	2ER36W...	2EL36W...	0.45	0.6	0.6			
		32	2ER32W...	2EL32W...	0.51	0.6	0.6			
		28	2ER28W...	2EL28W...	0.58	0.6	0.7			
		26	2ER26W...	2EL26W...	0.63	0.7	0.8			
		24	2ER24W...	2EL24W...	0.68	0.7	0.8			
		22	2ER22W...	2EL22W...	0.74	0.8	0.9			
		20	2ER20W...	2EL20W...	0.81	0.8	0.9			
		19	2ER19W...	2EL19W...	0.86	0.8	1.0			
		18	2ER18W...	2EL18W...	0.90	0.8	1.0			
3/8"	16	72	3ER72W...	3EL72W...	0.23	0.7	0.4	YE3	YI3	AL...-3 (LH)
		60	3ER60W...	3EL60W...	0.27	0.7	0.4			
		56	3ER56W...	3EL56W...	0.29	0.7	0.4			
		48	3ER48W...	3EL48W...	0.34	0.6	0.6			
		40	3ER40W...	3EL40W...	0.41	0.6	0.6			
		36	3ER36W...	3EL36W...	0.45	0.6	0.6			
		32	3ER32W...	3EL32W...	0.51	0.6	0.6			
		30	3ER30W...	3EL30W...	0.55	0.6	0.7			
		28	3ER28W...	3EL28W...	0.58	0.6	0.7			
		26	3ER26W...	3EL26W...	0.63	0.7	0.8			
		24	3ER24W...	3EL24W...	0.68	0.7	0.8			
		22	3ER22W...	3EL22W...	0.74	0.8	0.9			
		20	3ER20W...	3EL20W...	0.81	0.8	0.9			
		19	3ER19W...	3EL19W...	0.86	0.8	1.0			
18	3ER18W...	3EL18W...	0.90	0.8	1.0					
16	3ER16W...	3EL16W...	1.02	0.9	1.1					
14	3ER14W...	3EL14W...	1.16	1.0	1.2					
12	3ER12W...	3EL12W...	1.36	1.1	1.4					
11	3ER11W...	3EL11W...	1.48	1.1	1.5					
10	3ER10W...	3EL10W...	1.63	1.1	1.5					
9	3ER9W...	3EL9W...	1.81	1.2	1.7					
8	3ER8W...	3EL8W...	2.03	1.2	1.5					



continued on next page ▶

# Whitworth - BSW, BSP, BSF, BSB (con't)

## External

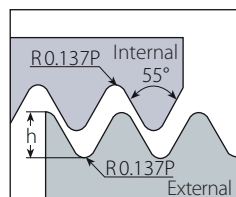

Defined by: B.S.84:1956, DIN 259, ISO228/1:1982  
Tolerance class: Medium class A

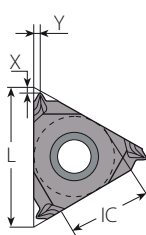

**SCB**  
Sintered  
Chipbreaker

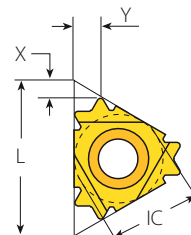

**V6**

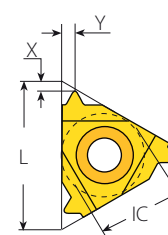



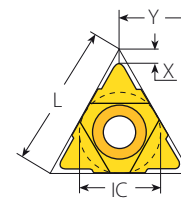

**Standard**



**U Style**

## Standard (con't)

Insert Size		Pitch	Ordering Code		Dimensions mm			Anvil		Toolholder	
IC	L mm	tpi	RH	LH	h min	X	Y	RH	LH		
 SCB	3/8" SCB	16	36	3JER36W...		0.45	1.2	0.5	YE3	-	AL..-3
			32	3JER32W...		0.51	1.2	0.5			
			28	3JER28W...		0.58	0.7	0.8			
			24	3JER24W...		0.68	0.7	0.8			
			20	3JER20W...		0.81	0.7	0.8			
			19	3JER19W...		0.86	0.7	0.8			
			18	3JER18W...		0.90	0.8	0.8			
			16	3JER16W...		1.02	0.8	0.8			
			14	3JER14W...		1.16	1.3	1.5			
			12	3JER12W...		1.36	1.3	1.5			
			11	3JER11W...		1.48	1.3	1.5			
 V6	3/8" V6	16	19	3ER19W-6C...		0.86	1.8	2.2	YE3-6C	-	AL..-3
			16	3ER16W-6C...		1.02	1.6	2.4			
			14	3ER14W-6C...		1.16	1.8	2.7			
			12	3ER12W-6C...		1.36	1.9	3.0			
 Standard	1/2"	22	7	4ER7W...	4EL7W...	2.41	1.6	2.3	YE4	YI4	AL..-4 (LH)
			6	4ER6W...	4EL6W...	2.71	1.6	2.3			
 U Style	5/8"	27	4.5	5ER4.5W...	5EL4.5W...	3.61	1.8	2.6	YE5	YI5	AL..-5 (LH)
			5	4ER5W...	4EL5W...	3.25	1.7	2.4			
			4	5ER4W...	5EL4W...	4.07	2.0	2.9			

## U Style

Insert Size		Pitch	Ordering Code		Dimensions mm			Anvil		Toolholder	
IC	L mm	tpi	RH+LH		h min	X	Y	RH	LH		
 U Style	1/2"U	22	4.5	4UEI4.5W...		3.61	2.3	11.0	YE4U	YI4U	AL..-4U (LH)
			4	4UEI4W...		4.07	1.8	11.0			
			3.5	4UEI3.5W...		4.65	2.1	11.0			
			3.25	4UEI3.25W...		5.00	2.0	11.0			
5/8"U	27	3.5	5UEI3.5W...		4.65	2.1	13.7	YE5U	YI5U	AL..-5U (LH)	
		3.25	5UEI3.25W...		5.00	2.0	13.7				
		3	5UEI3W...		5.42	2.3	13.7				
		2.75	5UEI2.75W...		5.91	2.4	13.7				



## Whitworth - BSW, BSP, BSF, BSB (con't)

### External

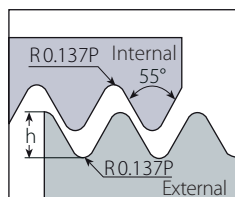

Defined by: B.S.84:1956, DIN 259, ISO228/1:1982  
Tolerance class: Medium class A

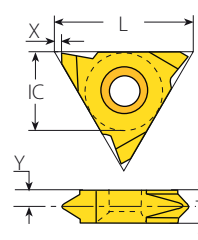

V Style / Slim Throat

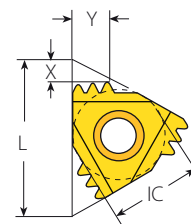

M+ Style

### Slim Throat



Insert Size		Pitch	Ordering Code		Dimensions mm				Toolholder
IC	L mm	tpi	RH	LH	h min	X	Y	T	
1/4"V	11	19	2VER19W...	2VEL19W...	0.86	0.69	2.3	3.2	NL..-2V (LH)
		14	2VER14W...	2VEL14W...	1.16	0.69	2.0	3.2	
		11	2VER11W...	2VEL11W...	1.48	0.69	1.7	3.2	
3/8"V	16	19	3VER19W...	3VEL19W...	0.86	1.1	2.7	3.6	NL..-3V (LH)
		18	3VER18W...	3VEL18W...	0.90	1.1	2.6	3.6	
		16	3VER16W...	3VEL16W...	1.02	1.1	2.6	3.6	
		14	3VER14W...	3VEL14W...	1.16	1.1	2.4	3.6	
		12	3VER12W...	3VEL12W...	1.36	1.1	2.2	3.6	
		11	3VER11W...	3VEL11W...	1.48	1.1	2.1	3.6	

### V Style



Insert Size		Pitch	Ordering Code		Dimensions mm				Toolholder
IC	L mm	tpi	RH	LH	h min	X	Y	T	
5/8"V	27	4	5VER4W...	5VEL4W...	4.07	1.0	3.3	6	NL..-5V-6 (LH)
		3	5VER3W...	5VEL3W...	5.42	1.0	4.3	8	NL..-5V-8 (LH)
		2.5	5VER2.5W...	5VEL2.5W...	6.51	1.0	5.2	10	NL..-5V-10 (LH)

### M+ Style



Insert Size		Pitch	Teeth	Ordering Code		Dimensions mm			Anvil	Toolholder
IC	L mm	tpi	RH	h min	X	Y	RH			
3/8"	16	28	2	3ER28W2M+...	0.58	1.2	1.6	YE3M	AL..-3	
		19	2	3ER19W2M+...	0.86	1.6	2.3			
		19	3	3ER19W3M+...	0.86	2.2	3.4			
		14	2	3ER14W2M+...	1.16	2.0	3.0			
1/2"	22	14	3	4ER14W3M+...	1.16	2.9	4.6	YE4M	AL..-4	
		11	2	4ER11W2M+...	1.48	2.3	3.5			

# Whitworth - BSW, BSP, BSF, BSB (con't)

## Internal

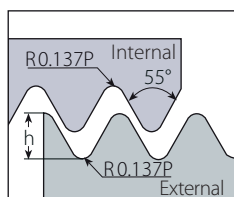

Defined by: B.S.84:1956, DIN 259, ISO228/1:1982  
Tolerance class: Medium class A

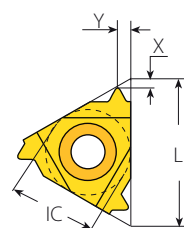

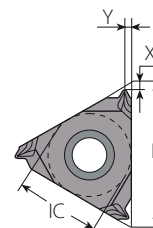

Standard

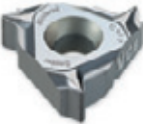

SCB  
Sintered  
Chipbreaker

## Standard

Insert Size		Pitch	Ordering Code		Dimensions mm			Anvil		Toolholder	
IC	L mm	tpi	RH	LH	h min	X	Y	RH	LH		
	1/4"	11	72	2IR72W...	2IL72W...	0.23	0.7	0.4	-	-	NVR..-2 (LH)
			60	2IR60W...	2IL60W...	0.27	0.7	0.4			
			56	2IR56W...	2IL56W...	0.29	0.7	0.4			
			48	2IR48W...	2IL48W...	0.34	0.6	0.6			
			40	2IR40W...	2IL40W...	0.41	0.6	0.6			
			36	2IR36W...	2IL36W...	0.45	0.6	0.6			
			32	2IR32W...	2IL32W...	0.51	0.6	0.6			
			28	2IR28W...	2IL28W...	0.58	0.6	0.7			
			26	2IR26W...	2IL26W...	0.63	0.7	0.8			
			24	2IR24W...	2IL24W...	0.68	0.7	0.8			
			22	2IR22W...	2IL22W...	0.74	0.8	0.9			
			20	2IR20W...	2IL20W...	0.81	0.8	0.9			
			19	2IR19W...	2IL19W...	0.86	0.8	1.0			
			18	2IR18W...	2IL18W...	0.90	0.8	1.0			
	1/4" SCB	11	36	2JIR36W...		0.45	1.2	0.5	-	-	NVR..-2
			32	2JIR32W...		0.51	1.2	0.5			
			28	2JIR28W...		0.58	0.7	0.8			
			24	2JIR24W...		0.68	0.7	0.8			
			20	2JIR20W...		0.81	0.7	0.8			
			19	2JIR19W...		0.86	0.6	0.8			
			18	2JIR18W...		0.90	0.8	0.8			
			16	2JIR16W...		1.02	0.8	0.8			
	3/8"	16	72	3IR72W...	3IL72W...	0.23	0.7	0.4	YI3	YE3	AVR..-3 (LH)
			60	3IR60W...	3IL60W...	0.27	0.7	0.4			
			56	3IR56W...	3IL56W...	0.29	0.7	0.4			
			48	3IR48W...	3IL48W...	0.34	0.6	0.6			
			40	3IR40W...	3IL40W...	0.41	0.6	0.6			
			36	3IR36W...	3IL36W...	0.45	0.6	0.6			
			32	3IR32W...	3IL32W...	0.51	0.6	0.6			
			30	3IR30W...	3IL30W...	0.55	0.6	0.7			

continued on next page ▶

# Whitworth - BSW, BSP, BSF, BSB (con't)

## Internal

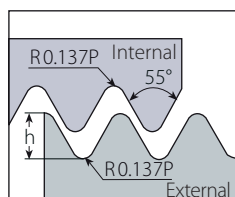

Defined by: B.S.84:1956, DIN 259, ISO228/1:1982  
Tolerance class: Medium class A

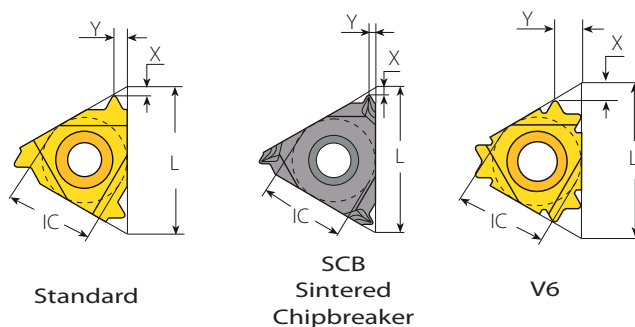

## Standard (con't)



Insert Size		Pitch	Ordering Code		Dimensions mm			Anvil		Toolholder
IC	L mm	tpi	RH	LH	h min	X	Y	RH	LH	
3/8"	16	28	3IR28W...	3IL28W...	0.58	0.6	0.7	Y13	YE3	AVR..-3 (LH)
		26	3IR26W...	3IL26W...	0.63	0.7	0.8			
		24	3IR24W...	3IL24W...	0.68	0.7	0.8			
		22	3IR22W...	3IL22W...	0.74	0.8	0.9			
		20	3IR20W...	3IL20W...	0.81	0.8	0.9			
		19	3IR19W...	3IL19W...	0.86	0.8	1.0			
		18	3IR18W...	3IL18W...	0.90	0.8	1.0			
		16	3IR16W...	3IL16W...	1.02	0.9	1.1			
		14	3IR14W...	3IL14W...	1.16	1.0	1.2			
		12	3IR12W...	3IL12W...	1.36	1.1	1.4			
		11	3IR11W...	3IL11W...	1.48	1.1	1.5			
		10	3IR10W...	3IL10W...	1.63	1.1	1.5			
3/8" SCB	16	28	3JIR28W...		0.58	0.7	0.8	Y13	-	AVR...-3
		24	3JIR24W...		0.68	0.7	0.8			
		20	3JIR20W...		0.81	0.7	0.8			
		19	3JIR19W...		0.86	0.6	0.5			
		18	3JIR18W...		0.90	0.8	0.8			
		16	3JIR16W...		1.02	0.8	0.8			
		14	3JIR14W...		1.16	1.3	1.5			
		12	3JIR12W...		1.36	1.3	1.5			
3/8" V6	16	19	3IR19W-6C...		0.86	1.7	2.2	Y13-6C	-	AVR..-3 NVRC..-3 206/...
		16	3IR16W-6C...		1.02	1.6	2.6			
		14	3IR14W-6C...		1.16	1.8	2.7			
		12	3IR12W-6C...		1.36	1.7	2.6			
1/2"	22	7	4IR7W...	4IL7W...	2.41	1.6	2.3	Y14	YE4	AVR..-4 (LH)
		6	4IR6W...	4IL6W...	2.71	1.6	2.3			
		5	4IR5W...	4IL5W...	3.25	1.7	2.4			
5/8"	27	4.5	5IR4.5W...	5IL4.5W...	3.61	1.8	2.6	Y15	YE5	AVR..-5 (LH)
		4	5IR4W...	5IL4W...	4.07	2.0	2.9			

# Whitworth - BSW, BSP, BSF, BSB (con't)

## Internal

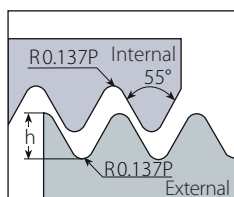

Defined by: B.S.84:1956, DIN 259, ISO228/1:1982  
Tolerance class: Medium class A

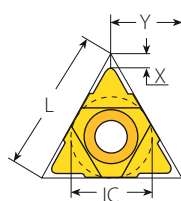

U Style

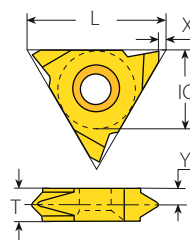

V Style

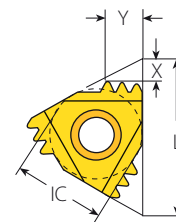

M+ Style

## U Style



Insert Size		Pitch	Ordering Code	Dimensions mm			Anvil		Toolholder
IC	L mm	tpi	RH+LH	h min	X	Y	RH	LH	
1/2"U	22	4.5	4UEI4.5W...	3.61	2.3	11.0	Y14U	YE4U	AVR..-4U (LH)
		4	4UEI4W...	4.07	1.8	11.0			
		3.5	4UEI3.5W...	4.65	2.1	11.0			
		3.25	4UEI3.25W...	5.00	2.0	11.0			
5/8"U	27	3.5	5UEI3.5W...	4.65	2.1	13.7	Y15U	YE5U	AVR..-5U (LH)
		3.25	5UEI3.25W...	5.00	2.0	13.7			
		3	5UEI3W...	5.42	2.3	13.7			
		2.75	5UEI2.75W...	5.91	2.4	13.7			

## V Style



Insert Size		Pitch	Ordering Code		Dimensions mm				Toolholder
IC	L mm	tpi	RH	LH	h min	X	Y	T	
5/8"V	27	4	5VIR4W...	5VIL4W...	4.07	1.0	3.3	6	NVR..-5V (LH)
		3	5VIR3W...	5VIL3W...	5.42	1.0	4.3	8	
		2.5	5VIR2.5W...	5VIL2.5W...	6.51	1.0	5.2	10	

## M+ Style



Insert Size		Pitch	Teeth	Ordering Code	Dimensions mm			Anvil	Toolholder
IC	L mm	tpi	RH	h min	X	Y	RH		
3/8"	16	14	2	3IR14W2M+...	1.16	2.0	3.0	Y13M	AVR..-3
1/2"	22	11	2	4IR11W2M+...	1.48	2.3	3.5	Y14M	AVR..-4

# Whitworth - BSW, BSP, BSF, BSB (con't)



## Internal

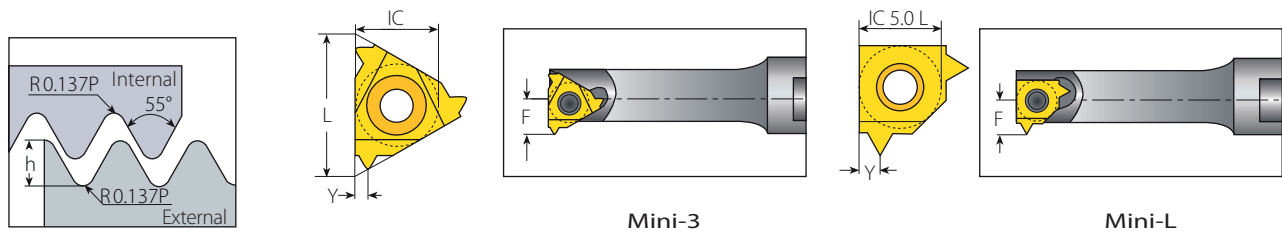

Defined by: B.S.84:1956, DIN 259, ISO228/1:1982  
Tolerance class: Medium class A

### Mini-3



Insert Size		Pitch	Ordering Code	Dimensions mm			Min. Bore dia.	Toolholder
IC	L mm	tpi	RH	h min	Y	F	mm	
4.0	6	26	4.0KIR26W...	0.63	0.6	3.6	6.25	.NVR.5-4.0K
		22	4.0KIR22W...	0.74	0.6	3.7	6.35	
		20	4.0KIR20W...	0.81	0.7	3.7	6.35	
		19	4.0KIR19W...	0.86	0.7	3.7	6.35	
		18	4.0KIR18W...	0.90	0.7	3.7	6.35	
6.0	10	28	6.0IR28W...	0.58	0.7	4.7	9.6	.NVR1.-6.0
		19	6.0IR19W...	0.86	1.0	5.0	9.9	
		14	6.0IR14W...	1.16	1.1	5.3	10.0	

### Mini-L



Insert Size		Pitch	Ordering Code	Dimensions mm			Min. Bore dia.	Toolholder
IC mm		tpi	RH	h min	Y	F	mm	
5.0 L		28	5LIR28W...	0.58	0.7	4.05	7.6	.NVR 10. -5L
		19	5LIR19W...	0.86	1.0	4.35	7.9	
		14	5LIR14W...	1.16	1.1	4.68	8.0	

# Whitworth - BSW, BSP, BSF, BSB (con't)



## Internal

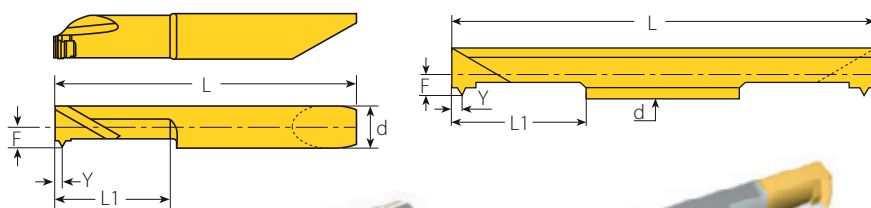
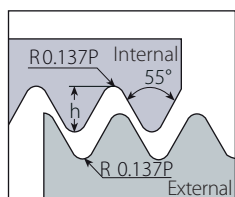

Defined by: B.S.84:1956, DIN 259, ISO228/1:1982  
Tolerance class: Medium class A



RH-Single Ended



RH-Double Ended

## Micro - Double Ended

Thread	Insert dia. d mm	Pitch tpi	Ordering Code RH/LH	Dimensions mm					Min. Bore dia.	Toolholder
				L1	L	F	Y	h min	mm	
1/16"-28BSP	4.0	28	4.0SIR28W...	16	50	1.86	0.65	0.58	4.2	SMC..-4.0
1/4"-26BSF		26	4.0SIR26W...	16	50	1.93	0.75	0.63	4.2	
1/4"-24BSW		24	4.0SIR24W...	16	50	1.96	0.75	0.68	4.3	
1/16"-28BSP	6.0	28	6.0SIR28W...	16	50	2.50	0.65	0.58	6.0	SMC..-6.0
5/16"-28BSW		26	6.0SIR26W...	16	50	2.50	0.75	0.63	6.0	
5/16"-24BSW		24	6.0SIR24W...	16	50	2.50	0.75	0.68	6.0	
5/16"-22BSW		22	6.0SIR22W...	16	50	2.50	0.90	0.74	6.0	
3/8"-20BSF		20	6.0SIR20W...	16	50	2.50	0.90	0.81	6.0	
1/4"-19BSP		19	6.0SIR19W...	16	50	2.50	0.95	0.86	6.0	

Left Handed Tool Supplied by Request. (Example: 6.0SIL19W...)

## Micro - Single Ended



Thread	Insert dia. d mm	Pitch tpi	Ordering Code RH/LH	Dimensions mm					Min. Bore dia.	Toolholder
				L1	L	F	Y	h min	mm	
1/16"-28BSP	6.0	28	M659TH 28W L16R/L	16	42	2.90	0.65	0.58	6.5	MHC..-6
1/4"-19BSP		19	M659TH 19W L16R/L	16	42	2.90	0.95	0.86	11.4	

Left Handed Tool Supplied by Request. (Example: M659TH 28W L16L)

# BSPT

## External

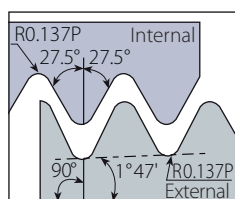

Defined by: B.S. 21:1985  
Tolerance class: Standard BSPT

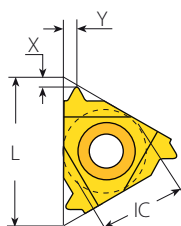

Standard

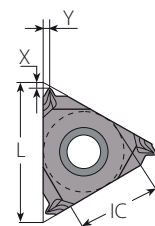

SCB  
Sintered  
Chipbreaker

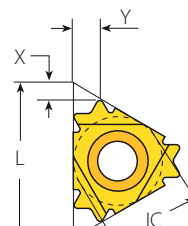

V6

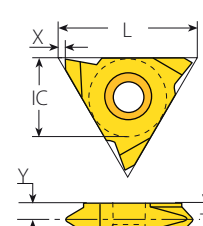

Slim Throat

## Standard

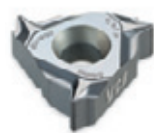

SCB



V6

Insert Size		Pitch	Ordering Code		Dimensions mm			Anvil		Toolholder
IC	L mm	tpi	RH	LH	h min	X	Y	RH	LH	
1/4"	11	28	2ER28BSPT...	2EL28BSPT...	0.58	0.6	0.6	-	-	NL...-2 (LH)
		19	2ER19BSPT...	2EL19BSPT...	0.86	0.8	0.9	-	-	
		14	2ER14BSPT...	2EL14BSPT...	1.16	0.9	1.0	-	-	
3/8"	16	28	3ER28BSPT...	3EL28BSPT...	0.58	0.6	0.6	YE3	YI3	AL...-3 (LH)
		19	3ER19BSPT...	3EL19BSPT...	0.86	0.8	0.9			
		14	3ER14BSPT...	3EL14BSPT...	1.16	1.0	1.2			
		11	3ER11BSPT...	3EL11BSPT...	1.48	1.1	1.5			
3/8" SCB	16	28	3JER28BSPT...		0.58	0.7	0.8	YE3	-	AL...-3
		19	3JER19BSPT...		0.86	0.7	0.8			
		14	3JER14BSPT...		1.16	1.3	1.5			
3/8" V6	16	19	3ER19BSPT-6C...		0.86	1.7	2.2	YE3-6C	-	AL...-3
		14	3ER14BSPT-6C...		1.16	1.9	2.8			

## Slim Throat



Insert Size		Pitch	Ordering Code		Dimensions mm				Toolholder
IC	L mm	tpi	RH	LH	h min	X	Y	T	
3/8"V	16	28	3VER28BSPT...	3VEL28BSPT...	0.58	1.1	3.0	3.6	NL...-3V (LH)
		19	3VER19BSPT...	3VEL19BSPT...	0.86	1.1	2.7	3.6	
		14	3VER14BSPT...	3VEL14BSPT...	1.16	1.1	2.4	3.6	
		11	3VER11BSPT...	3VEL11BSPT...	1.48	1.1	2.1	3.6	

# BSPT (con't)

## Internal

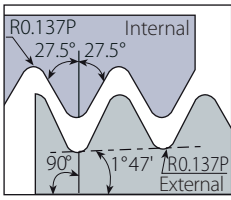

Defined by: B.S. 21:1985  
Tolerance class: Standard BSPT

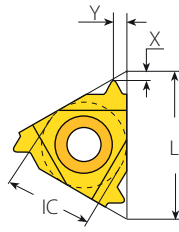

Standard

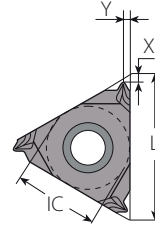

SCB  
Sintered  
Chipbreaker

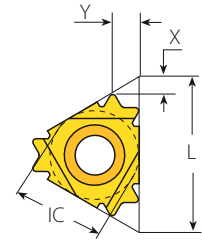

V6

## Standard

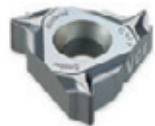

SCB



V6

Insert Size		Pitch	Ordering Code		Dimensions mm			Anvil		Toolholder
IC	L mm	tpi	RH	LH	h min	X	Y	RH	LH	
1/4"	11	28	2IR28BSPT...	2IL28BSPT...	0.58	0.6	0.6	-	-	NVR..-2 (LH)
		19	2IR19BSPT...	2IL19BSPT...	0.86	0.8	0.9			
		14	2IR14BSPT...	2IL14BSPT...	1.16	0.9	1.0			
1/4" SCB	11	28	2JIR28BSPT...		0.58	0.7	0.8	-	-	NVR..-2
		19	2JIR19BSPT...		0.86	0.7	0.8			
3/8"	16	28	3IR28BSPT...	3IL28BSPT...	0.58	0.6	0.6	YI3	YE3	AVR..-3 (LH)
		19	3IR19BSPT...	3IL19BSPT...	0.86	0.8	0.9			
		14	3IR14BSPT...	3IL14BSPT...	1.16	1.0	1.2			
		11	3IR11BSPT...	3IL11BSPT...	1.48	1.1	1.5			
3/8" SCB	16	28	3JIR28BSPT...		0.58	0.7	0.8	YI3	-	AVR..-3
		19	3JIR19BSPT...		0.86	0.7	0.8			
		14	3JIR14BSPT...		1.16	1.3	1.5			
		11	3JIR11BSPT...		1.48	1.3	1.5			
3/8" V6	16	19	3IR19BSPT-6C...		0.86	1.8	2.3	YI3-6C	-	AVR..-3 NVRC..-3 206/..
		14	3IR14BSPT-6C...		1.16	1.9	2.7			

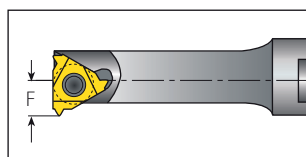
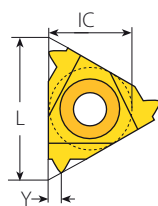
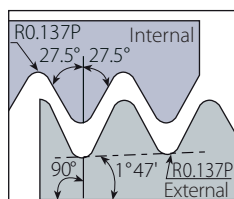

**BSPT (con't)**

**Internal**

Mini-3

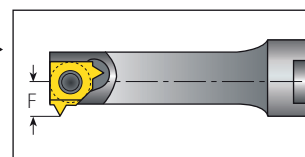
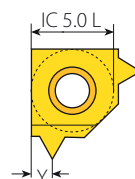

Mini-L

Defined by: B.S. 21:1985  
Tolerance class: Standard BSPT

**Mini-3**



Insert Size		Pitch	Ordering Code	Dimensions mm			Min. Bore dia.	Toolholder
IC	L mm	tpi	RH	h min	Y	F	mm	
4.0	6	28	4.0KIR28BSPT...	0.58	0.6	3.6	6.25	.NVR.5-4.0K
		28	6.0IR28BSPT...	0.58	0.6	4.7	9.6	
6.0	10	19	6.0IR19BSPT...	0.86	0.9	5.0	9.9	.NVR1...-6.0
		14	6.0IR14BSPT...	1.16	1.2	5.3	10.0	

**Mini-L**

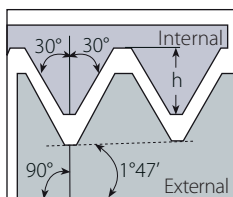

Insert Size		Pitch	Ordering Code	Dimensions mm			Min. Bore dia.	Toolholder
IC mm		tpi	RH	h min	Y	F	mm	
5.0L		28	5LIR28BSPT...	0.58	0.6	4.05	7.6	.NVR10. -5L
		19	5LIR19BSPT...	0.86	0.9	4.35	7.9	
		14	5LIR14BSPT...	1.16	1.2	4.68	8.0	

# NPT

## External

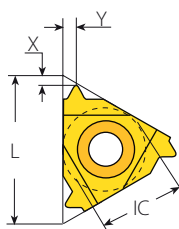

Defined by: USAS B2.1:1968  
Tolerance class: Standard NPT



Standard

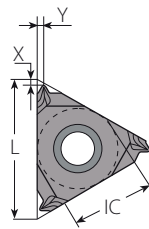

SCB  
Sintered  
Chipbreaker

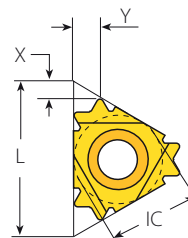



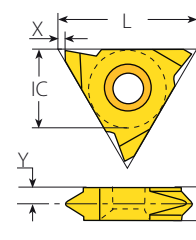

V6



Slim Throat

## Standard

Insert Size		Pitch	Ordering Code		Dimensions mm			Anvil		Toolholder	
IC	L mm	tpi	RH	LH	h min	X	Y	RH	LH		
	1/4"	11	27	2ER27NPT...	2EL27NPT...	0.66	0.7	0.8	-	-	NL...-2 (LH)
			18	2ER18NPT...	2EL18NPT...	1.01	0.8	1.0	-	-	
			14	2ER14NPT...	2EL14NPT...	1.33	0.8	1.0	-	-	
	3/8"	16	27	3ER27NPT...	3EL27NPT...	0.66	0.7	0.8	YE3	YI3	AL...-3 (LH)
			18	3ER18NPT...	3EL18NPT...	1.01	0.8	1.0			
			14	3ER14NPT...	3EL14NPT...	1.33	0.9	1.2			
			11.5	3ER11.5NPT...	3EL11.5NPT...	1.64	1.1	1.5			
	3/8" SCB	16	27	3JER27NPT...		0.66	0.6	0.8	YE3	-	AL...-3
			18	3JER18NPT...		1.01	0.6	0.8			
			14	3JER14NPT...		1.33	1.1	1.5			
			11.5	3JER11.5NPT...		1.64	1.1	1.5			
	3/8" V6	16	14	3ER14NPT-6C...		1.33	1.9	3.0	YE3-6C	-	AL...-3

## Slim Throat

Insert Size		Pitch	Ordering Code		Dimensions mm				Toolholder	
IC	L mm	tpi	RH	LH	h min	X	Y	T		
	1/4"V	11	27	2VER27NPT...	2VEL27NPT...	0.66	0.7	2.0	3.2	NL...-2V (LH)
			18	2VER18NPT...	2VEL18NPT...	1.01	0.7	1.8	3.2	
			14	2VER14NPT...	2VEL14NPT...	1.33	0.7	1.8	3.2	
			11.5	2VER11.5NPT...	2VEL11.5NPT...	1.64	0.7	2.1	3.2	
3/8"V	16	27	3VER27NPT...	3VEL27NPT...	0.66	1.1	2.9	3.6	NL...-3V (LH)	
		18	3VER18NPT...	3VEL18NPT...	1.01	1.1	2.6	3.6		
		11.5	3VER11.5NPT...	3VEL11.5 NPT...	1.64	1.1	2.1	3.6		

## NPT (con't)

### External

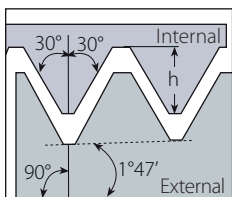

Defined by: USAS B2.1:1968  
Tolerance class: Standard NPT

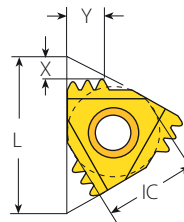

M+ Style

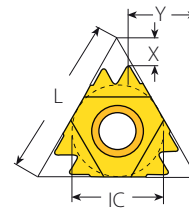

Z+ Style

### M+ Style



Insert Size		Pitch	Teeth	Ordering Code	Dimensions mm			Anvil	
IC	L mm	tpi		RH	h min	X	Y	RH	Toolholder
3/8"	16	14	2	3ER14NPT2M+...	1.33	2.0	3.0	YE3M	AL..-3
1/2"	22	11.5	2	4ER11.5NPT2M+...	1.64	2.2	3.4	YE4M	AL..-4
5/8"	27	11.5	3	5ER11.5NPT3M+...	1.64	3.5	5.6	YE5M	AL..-5M
		8	2	5ER8NPT2M+...	2.42	3.1	4.9		

### Z+ Style



Insert Size		Pitch	Teeth	Ordering Code	Dimensions mm			Anvil	
IC	L mm	tpi		RH	h min	X	Y	RH	Toolholder
1/2"	22	11.5	2	4ER11.5NPT2Z+...	1.64	2.7	10.0	YE4Z	AL..-4Z
		8	2	4ER8NPT2Z+...	2.42	3.4	9.6		

## NPT (con't)

### Internal

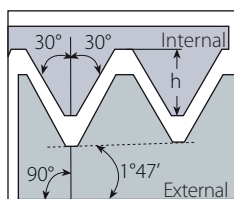

Defined by: USAS B2.1:1968  
Tolerance class: Standard NPT

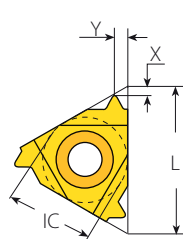

Standard

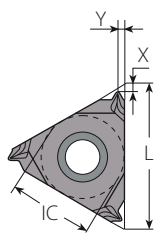

SCB  
Sintered  
Chipbreaker

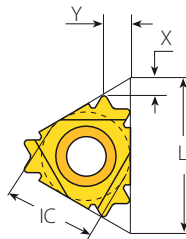

V6

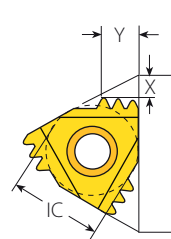

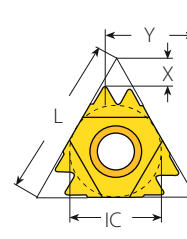

M+ Style

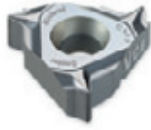

Z+ Style

### Standard

IC	Insert Size		Pitch	Ordering Code		Dimensions mm			Anvil		Toolholder
	L mm	tpi	RH	LH	h min	X	Y	RH	LH		
	1/4"	11	27	2IR27NPT...	2IL27NPT...	0.66	0.7	0.8	-	-	NVR..-2 (LH)
			18	2IR18NPT...	2IL18NPT...	1.01	0.8	1.0	-	-	
			14	2IR14NPT...	2IL14NPT...	1.33	0.8	1.0	-	-	
	1/4" SCB	11	27	2JIR27NPT...		0.66	0.6	0.8	-	-	NVR..-2
			18	2JIR18NPT...		1.01	0.6	0.8	-	-	
			14	2JIR14NPT...		1.33	0.6	0.8	-	-	
	3/8"	16	27	3IR27NPT...	3IL27NPT...	0.66	0.7	0.8	YI3	YE3	AVR..-3 (LH)
			18	3IR18NPT...	3IL18NPT...	1.01	0.8	1.0			
			14	3IR14NPT...	3IL14NPT...	1.33	0.9	1.2			
			11.5	3IR11.5NPT...	3IL11.5NPT...	1.64	1.1	1.5			
			8	3IR8NPT...	3IL8NPT...	2.42	1.3	1.8			
	3/8" SCB	16	27	3JIR27NPT...		0.66	0.6	0.8	YI3	-	AVR..-3
			18	3JIR18NPT...		1.01	0.6	0.8			
			14	3JIR14NPT...		1.33	1.1	1.5			
			11.5	3JIR11.5NPT...		1.64	1.1	1.5			
			8	3JIR8NPT...		2.42	1.0	1.5			
3/8" V6	16	14	3IR14NPT-6C...		1.33	1.9	2.8	YI3-6C	-	AVR..-3 NVRC..-3 206/...	

### M+ Style



IC	Insert Size		Pitch	Teeth	Ordering Code	Dimensions mm			Anvil	
	L mm	tpi	RH	LH	h min	X	Y	RH	Toolholder	
	3/8"	16	14	2	3IR14NPT2M+...	1.33	2.0	3.0	YI3M	AVR..-3
			11.5	2	4IR11.5NPT2M+...	1.64	2.2	3.4	YI4M	AVR..-4
			5/8"	27	11.5	3	5IR11.5NPT3M+...	1.64	3.5	5.6
8	2	5IR8NPT2M+...			2.42	3.1	4.9			

### Z+ Style



IC	Insert Size		Pitch	Teeth	Ordering Code	Dimensions mm			Anvil	
	L mm	tpi	RH	LH	h min	X	Y	RH	Toolholder	
	1/2"	22	11.5	2	4IR11.5NPT2Z+...	1.64	2.7	10.0	YI4Z	AVR..-4Z
			8	2	4IR8NPT2Z+...	2.42	3.4	9.6		

# NPT (con't)



## Internal

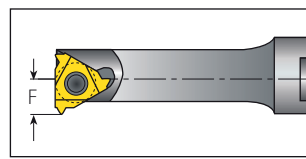
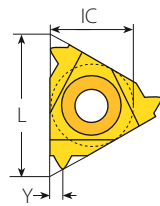
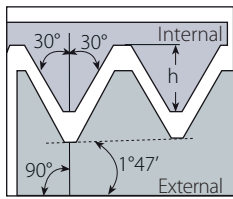

Mini-3

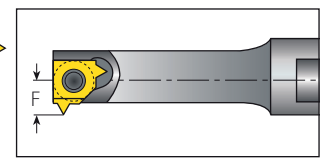
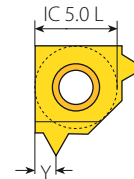

Mini-L

Defined by: USAS B2.1:1968  
 Tolerance class: Standard NPT

## Mini-3



Insert Size		Pitch	Ordering Code	Dimensions mm			Min. Bore dia.	Toolholder
IC	L mm	tpi	RH	h min	Y	F	mm	
4.0	6.0	27	4.0KIR27NPT...	0.66	0.6	3.7	6.35	.NVR.5-4.0K
		27	6.0IR27NPT...	0.66	0.8	5.3		
6.0	10	18	6.0IR18NPT...	1.01	1.0	5.3	10.0	.NVR1..-6.0
		14	6.0IR14NPT...	1.33	1.1	5.3		

## Mini-L



Insert Size		Pitch	Ordering Code	Dimensions mm			Min. Bore dia.	Toolholder
IC mm		tpi	RH	h min	Y	F	mm	
5.0L		27	5LIR27NPT...	0.66	0.8	4.65	8.0	.NVR10-5L
		18	5LIR18NPT...	1.01	1.0	4.65		
		14	5LIR14NPT...	1.33	1.1	4.65		

# NPT

## Internal

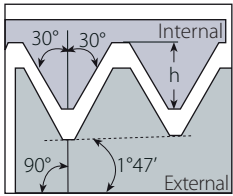

Defined by: USAS B2.1:1968  
Tolerance class: Standard NPT

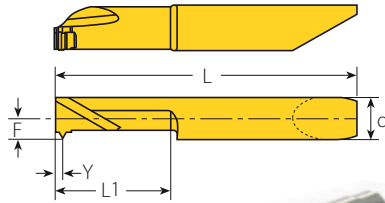

RH-Single Ended

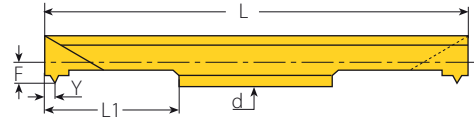

RH-Double Ended

## Micro - Double Ended

Thread	Insert dia.		Pitch	Ordering Code		Dimensions mm				Min. Bore dia.	Toolholder
	d mm	mm		RH/LH	L1	L	F	Y	h min		
1/16"-27NPT	6.0	mm	27	6.0SIR27NPT...	16	50	2.50	1.00	0.66	5.9	SMC.-6.0
1/4"-18NPT			18	6.0SIR18NPT...	16	50	2.50	0.80	1.01	6.0	

Left Handed Tool Supplied by Request. (Example: 6.0SIL18NPT...)

## Micro - Single Ended

**microscope**

Thread	Insert dia.		Pitch	Ordering Code		Dimensions mm				Min. Bore dia.	Toolholder
	d mm	mm		RH/LH	L1	L	F	Y	h min		
1/16"-27NPT	6.0	mm	27	M659TH 27NPT L16R/L	16	42	2.90	0.75	0.66	6.1	MHC.-6
1/4"-18NPT			18	M659TH 18NPT L16R/L	16	42	2.90	1.00	1.01	10.7	

Left Handed Tool Supplied by Request. (Example: M659TH 27NPT L16L)

# NPTF

## External

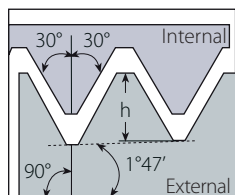

Defined by: ANSI B1.20.3-1976  
Tolerance class: Class 2

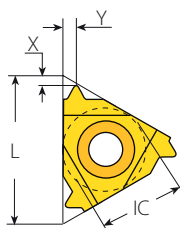

Standard

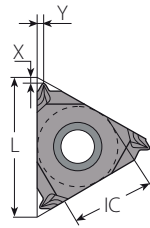

SCB  
Sintered  
Chipbreaker

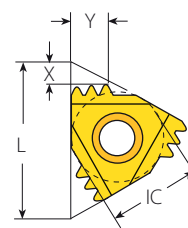

M+ Style

## Standard

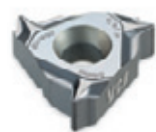

SCB

Insert Size		Pitch	Ordering Code		Dimensions mm			Anvil		Toolholder
IC	L mm	tpi	RH	LH	h min	X	Y	RH	LH	
1/4"	11	27	2ER27NPTF...	2EL27NPTF...	0.64	0.7	0.8	-	-	NL...-2 (LH)
		18	2ER18NPTF...	2EL18NPTF...	1.00	0.8	1.0	-	-	
		14	2ER14NPTF...	2EL14NPTF...	1.35	0.8	1.0	-	-	
3/8"	16	27	3ER27NPTF...	3EL27NPTF...	0.64	0.7	0.8	YE3	YI3	AL...-3 (LH)
		18	3ER18NPTF...	3EL18NPTF...	1.00	0.8	1.0			
		14	3ER14NPTF...	3EL14NPTF...	1.35	0.9	1.2			
		11.5	3ER11.5NPTF...	3EL11.5NPTF...	1.63	1.1	1.5			
3/8" SCB	16	27	3JER27NPTF...		0.64	0.7	0.8	YE3	-	AL...-3
		18	3JER18NPTF...		1.00	0.6	0.8			
		14	3JER14NPTF...		1.35	1.1	1.5			
		11.5	3JER11.5NPTF...		1.63	1.1	1.5			
		8	3JER8NPTF...		2.38	1.1	1.5			

## M+ Style



Insert Size		Pitch	Teeth	Ordering Code	Dimensions mm			Anvil		Toolholder
IC	L mm	tpi		RH	h min	X	Y	RH		
3/8"	16	14	2	3ER14NPTF2M+...	1.35	2.0	3.0	YE3M	AL...-3	

**Multi**plus

# NPTF (con't)

## Internal

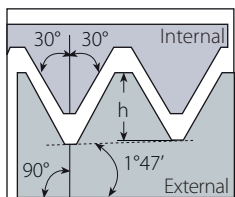

Defined by: ANSI B1.20.3-1976  
Tolerance class: Class 2

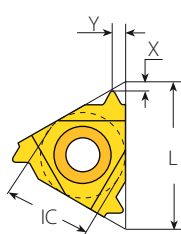

Standard

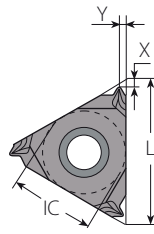

SCB  
Sintered  
Chipbreaker

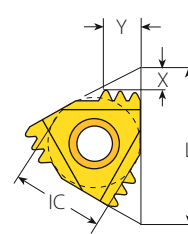

M+ Style

## Standard

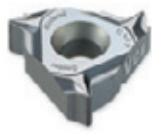
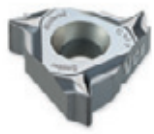
Insert Size		Pitch	Ordering Code		Dimensions mm			Anvil		Toolholder				
IC	L mm	tpi	RH	LH	h min	X	Y	RH	LH					
	1/4"	11	27	2IR27NPTF...	2IL27NPTF...	0.64	0.7	0.8	-	-	NVR..-2 (LH)			
			18	2IR18NPTF...	2IL18NPTF...	1.00	0.8	1.0						
			14	2IR14NPTF...	2IL14NPTF...	1.35	0.8	1.0						
	1/4" SCB	11	27	2JIR27NPTF...		0.64	0.7	0.8	-	-	NVR..-2			
			18	2JIR18NPTF...		1.00	0.6	0.8						
			27	3IR27NPTF...	3IL27NPTF...	0.64	0.7	0.8				YI3	YE3	AVR..-3 (LH)
			18	3IR18NPTF...	3IL18NPTF...	1.00	0.8	1.0						
			14	3IR14NPTF...	3IL14NPTF...	1.35	0.9	1.2						
11.5	3IR11.5NPTF...	3IL11.5NPTF...	1.63	1.1	1.5									
	3/8" SCB	16	8	3IR8NPTF...	3IL8NPTF...	2.38	1.3	1.8	YI3	-	AVR..-3			
			27	3JIR27NPTF...		0.64	0.7	0.8						
			18	3JIR18NPTF...		1.00	0.6	0.8						
			14	3JIR14NPTF...		1.35	1.1	1.5						
			11.5	3JIR11.5NPTF...		1.63	1.1	1.5						

## M+ Style



Insert Size		Pitch	Teeth	Ordering Code	Dimensions mm			Anvil		Toolholder
IC	L mm	tpi		RH	h min	X	Y	RH		
3/8"	16	14	2	3IR14NPTF2M+...		1.35	2.0	3.0	YI3M	AVR..-3



## NPTF (con't)



### Internal

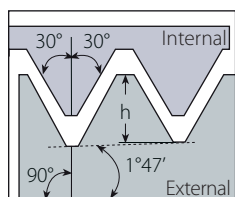

Defined by: ANSI B1.20.3-1976  
Tolerance class: Class 2

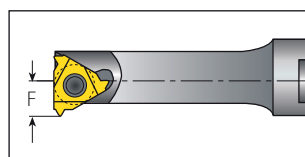
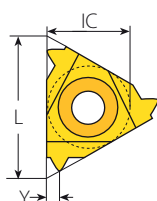

Mini-3

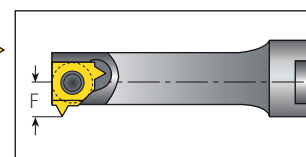
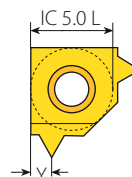

Mini-L

### Mini-3



Insert Size		Pitch	Ordering Code	Dimensions mm			Min. Bore dia.	Toolholder
IC	L mm	tpi	RH	h min	Y	F	mm	
4.0	6	27	4.0KIR27NPTF...	0.64	0.6	3.6	6.25	.NVR.5-4.0K
		27	6.0IR27NPTF...	0.64	0.8	5.3		
6.0	10	18	6.0IR18NPTF...	1.00	1.0	5.3	10.0	.NVR1.-6.0
		14	6.0IR14NPTF...	1.35	1.1	5.3		

### Mini-L



Insert Size		Pitch	Ordering Code	Dimensions mm			Min. Bore dia.	Toolholder
IC mm		tpi	RH	h min	Y	F	mm	
5.0L		27	5LIR27NPTF...	0.64	0.8	4.65	8.0	.NVR 10.-5L
		18	5LIR18NPTF...	1.00	1.0	4.65		
		14	5LIR14NPTF...	1.35	1.1	4.65		

## NPTF

### Internal

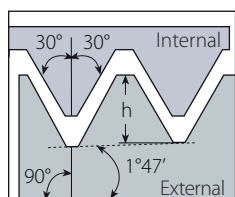

Defined by: ANSI B1.20.3-1976  
Tolerance class: Class 2

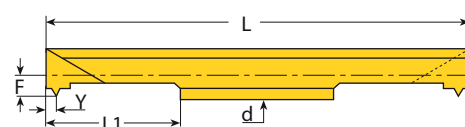

RH-Double Ended

### Micro - Double Ended

Insert dia.		Pitch	Ordering Code	Dimensions mm					Min. Bore dia.	Toolholder
Thread	d mm	tpi	RH/LH	L1	L	F	Y	h min	mm	
1/16"-27NPTF	6.0	27	6.0SIR27NPTF...	16	50	2.50	0.80	0.64	6.0	SMC.-6.0
1/4"-18NPTF		18	6.0SIR18NPTF...	16	50	2.50	1.00	1.00		

Left Handed Tool Supplied by Request. (Example: 6.0SIL18NPTF...)

# NPS

## External / Internal

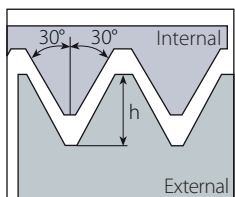

Defined by: USA NBS H28 (1957)  
Tolerance class: Standard NPS

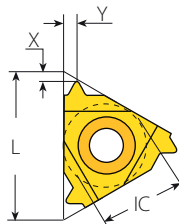

External - Standard

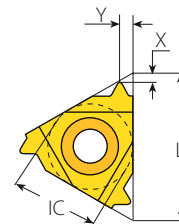

Internal - Standard

## External

### Standard



Insert Size		Pitch	Ordering Code		Dimensions mm			Anvil		Toolholder
IC	L mm	tpi	RH	LH	h min	X	Y	RH	LH	
3/8"	16	24	3ER24NPS...	3EL24NPS...	0.79	0.7	0.8	YE3	YI3	AL...-3 (LH)
		16	3ER16NPS...	3EL16NPS...	1.21	0.8	1.1			
		14	3ER14NPS...	3EL14NPS...	1.33	0.9	1.2			
		12	3ER12NPS...	3EL12NPS...	1.63	1.1	1.4			
		11.5	3ER11.5NPS...	3EL11.5NPS...	1.71	1.1	1.5			
1/2"	22	8	4ER8NPS...	4EL8NPS...	2.46	1.3	1.9	YE4	YI4	AL...-4 (LH)
		7	4ER7NPS...	4EL7NPS...	2.82	1.6	2.3			
		6	4ER6NPS...	4EL6NPS...	3.31	1.6	2.3			
5/8"	27	5	5ER5NPS...	5EL5NPS...	3.98	1.9	2.8	YE5	YI5	AL...-5 (LH)

## Internal

### Standard



Insert Size		Pitch	Ordering Code		Dimensions mm			Anvil		Toolholder
IC	L mm	tpi	RH	LH	h min	X	Y	RH	LH	
3/8"	16	24	3IR24NPS...	3IL24NPS...	0.79	0.7	0.8	YI3	YE3	AVR...-3 (LH)
		14	3IR14NPS...	3IL14NPS...	1.33	0.9	1.2			
		12	3IR12NPS...	3IL12NPS...	1.63	1.1	1.4			
		11.5	3IR11.5NPS...	3IL11.5NPS...	1.71	1.1	1.5			
1/2"	22	8	4IR8NPS...	4IL8NPS...	2.46	1.3	1.9	YI4	YE4	AVR...-4 (LH)
		7	4IR7NPS...	4IL7NPS...	2.82	1.6	2.3			
		6	4IR6NPS...	4IL6NPS...	3.31	1.6	2.3			
5/8"	27	5	5IR5NPS...	5IL5NPS...	3.98	1.9	2.8	YI5	YE5	AVR...-5 (LH)

## Round (DIN 405)

### External

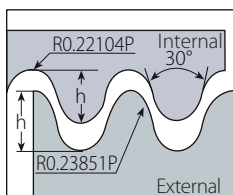

Defined by: DIN 405  
 Tolerance class: 7h/7H

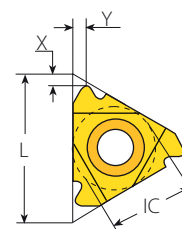

Standard

### Standard



Insert Size		Pitch	Ordering Code		Dimensions mm			Anvil		Toolholder
IC	L mm	tpi	RH	LH	h min	X	Y	RH	LH	
3/8"	16	10	3ER10RD...	3EL10RD...	1.27	1.1	1.2	YE3	YI3	AL..-3 (LH)
		8	3ER8RD...	3EL8RD...	1.59	1.4	1.3			
		6	3ER6RD...	3EL6RD...	2.12	1.5	1.7			
1/2"	22	6	4ER6RD...	4EL6RD...	2.12	1.5	1.7	YE4	YI4	AL..-4 (LH)
		4	4ER4RD...	4EL4RD...	3.18	2.2	2.3			
5/8"	27	4	5ER4RD...	5EL4RD...	3.18	2.2	2.3	YE5	YI5	AL..-5 (LH)

### Internal

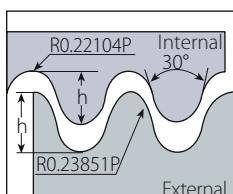

Defined by: DIN 405  
 Tolerance class: 7h/7H

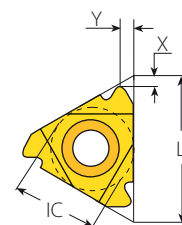

Standard

### Standard



Insert Size		Pitch	Ordering Code		Dimensions mm			Anvil		Toolholder
IC	L mm	tpi	RH	LH	h min	X	Y	RH	LH	
3/8"	16	10	3IR10RD...	3IL10RD...	1.27	1.1	1.2	YI3	YE3	AVR..-3 (LH)
		8	3IR8RD...	3IL8RD...	1.59	1.4	1.4			
		6	3IR6RD...	3IL6RD...	2.12	1.4	1.5			
1/2"	22	6	4IR6RD...	4IL6RD...	2.12	1.5	1.7	YI4	YE4	AVR..-4 (LH)
		4	4IR4RD...	4IL4RD...	3.18	2.2	2.3			
5/8"	27	4	5IR4RD...	5IL4RD...	3.18	2.2	2.3	YI5	YE5	AVR..-5 (LH)

## Round (DIN 20400)

### External

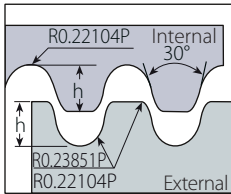

Defined by: DIN 20400  
Tolerance class: Standard

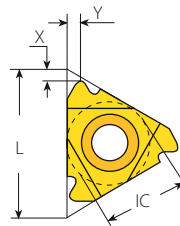

Standard

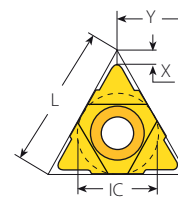

U Style

### Standard



Insert Size		Pitch	Ordering Code		Dimensions mm			Anvil		Toolholder
IC	L mm	mm	RH	LH	h min	X	Y	RH	LH	
1/2"	22	3.0	4ER3.0RD20400...	4EL3.0RD20400...	1.65	1.3	1.7	YE4	YI4	AL...-4 (LH)
		4.0	4ER4.0RD20400...	4EL4.0RD20400...	2.20	1.6	2.2			
		5.0	4ER5.0RD20400...	4EL5.0RD20400...	2.75	1.4	1.7			
		6.0	4ER6.0RD20400...	4EL6.0RD20400...	3.30	1.7	2.1			

### U Style



Insert Size		Pitch	Ordering Code	Dimensions mm			Anvil		Toolholder
IC	L mm	mm	RH+LH	h min	X	Y	RH	LH	
5/8"U	27	8.0	5UEI8.0RD20400...	4.4	2.9	13.5	YE5U	YI5U	AL...-5U (LH)

## Round (DIN 20400)

### Internal

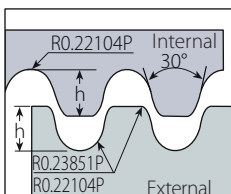

Defined by: DIN 20400  
Tolerance class: Standard

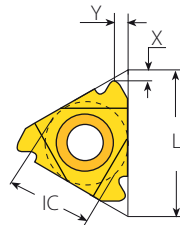

Standard

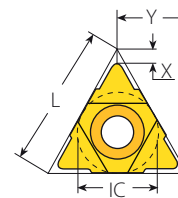

U Style

### Standard



Insert Size		Pitch	Ordering Code		Dimensions mm			Anvil		Toolholder
IC	L mm	mm	RH	LH	h min	X	Y	RH	LH	
1/2"	22	3.0	4IR3.0RD20400...	4IL3.0RD20400...	1.65	1.3	1.7	YI4	YE4	AVR...-4 (LH)
		4.0	4IR4.0RD20400...	4IL4.0RD20400...	2.20	1.6	2.2			
		5.0	4IR5.0RD20400...	4IL5.0RD20400...	2.75	1.4	1.7			
		6.0	4IR6.0RD20400...	4IL6.0RD20400...	3.30	1.7	2.1			

### U Style



Insert Size		Pitch	Ordering Code	Dimensions mm			Anvil		Toolholder
IC	L mm	mm	RH+LH	h min	X	Y	RH	LH	
5/8"U	27	8.0	5UEI8.0RD20400...	4.4	2.9	13.5	YI5U	YE5U	AVR...-5U (LH)

# Trapez

## External

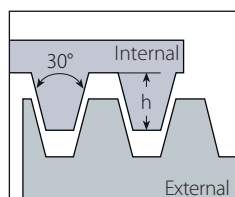

Defined by: DIN 103  
Tolerance class: 7e/7H

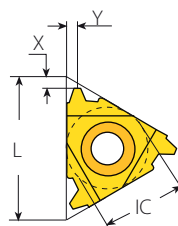

Standard

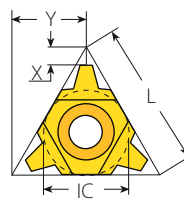

U Style

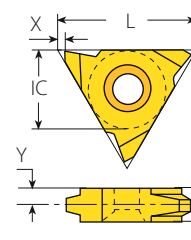

V Style

## Standard



Insert Size		Pitch	Ordering Code		Dimensions mm			Anvil		Toolholder
IC	L mm	mm	RH	LH	h min	X	Y	RH	LH	
1/4"	11	1.5	2ER1.5TR...	2EL1.5TR...	0.90	0.8	0.9	-	-	NL..-2 (LH)
		1.5	3ER1.5TR...	3EL1.5TR...	0.90	1.0	1.1			
3/8"	16	2.0	3ER2.0TR...	3EL2.0TR...	1.25	1.1	1.3	YE3	YI3	AL..-3 (LH)
		2.5	3ER2.5TR...	3EL2.5TR...	1.55	1.2	1.4			
		3.0	3ER3.0TR...	3EL3.0TR...	1.75	1.3	1.5			
1/2"	22	4.0	4ER4.0TR...	4EL4.0TR...	2.25	1.7	1.9	YE4	YI4	AL..-4 (LH)
		5.0	4ER5.0TR...	4EL5.0TR...	2.75	2.1	2.5			
		6.0	4ER6.0TR...	4EL6.0TR...	3.50	2.3	2.7			
5/8"	27	6.0	5ER6.0TR...	5EL6.0TR...	3.50	2.3	2.7	YE5	YI5	AL..-5 (LH)

## U Style



Insert Size		Pitch	Ordering Code		Dimensions mm			Anvil		Toolholder
IC	L mm	mm	RH+LH		h min	X	Y	RH	LH	
1/2"U	22	6.0	4UE6.0TR...		3.50	2.0	11.0	YE4U	YI4U	AL..-4U (LH)
		7.0	4UE7.0TR...		4.00	2.3	11.0			
		8.0	4UE8.0TR...		4.50	2.6	11.0			
5/8"U	27	8.0	5UE8.0TR...		4.50	2.6	13.7	YE5U	YI5U	AL..-5U (LH)
		9.0	5UE9.0TR...		5.00	3.0	13.7			

## V Style



Insert Size		Pitch	Ordering Code		Dimensions mm				Toolholder
IC	L mm	mm	RH	LH	h min	X	Y	T	
5/8"V	27	6.0	5VER6.0TR...	5VEL6.0TR...	3.50	1.0	3.3	6	NL..-5V-6 (LH)
		7.0	5VER7.0TR...	5VEL7.0TR...	4.00	1.0	3.3	6	
		8.0	5VER8.0TR...	5VEL8.0TR...	4.50	1.0	3.3	6	NL..-5V-8 (LH)
		9.0	5VER9.0TR...	5VEL9.0TR...	5.00	1.0	4.3	8	
		10.0	5VER10.0TR...	5VEL10.0TR...	5.50	1.0	4.3	8	
		12.0	5VER12.0TR...	5VEL12.0TR...	6.50	1.0	5.2	10	

# Trapez (con't)

## Internal

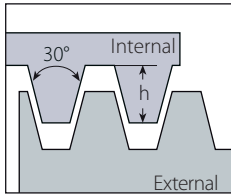

Defined by: DIN 103  
Tolerance class: 7e/7H

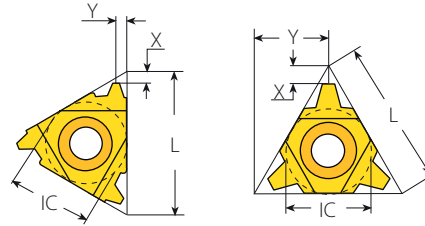

Standard

U Style

## Standard



Insert Size		Pitch	Ordering Code		Dimensions mm			Anvil		Toolholder
IC	L mm	mm	RH	LH	h min	X	Y	RH	LH	
1/4"	11	1.5	2IR1.5TR...	2IL1.5TR...	0.90	0.8	0.9	-	-	NVR 8-2 (LH)
3/8"	16	1.5	3IR1.5TR...	3IL1.5TR...	0.90	1.0	1.1	YI3	YE3	AVR.-3 (LH)
		2.0	3IR2.0TR...	3IL2.0TR...	1.25	1.1	1.3			
		2.5	3IR2.5TR...	3IL2.5TR...	1.53	1.2	1.4			
		3.0	3IR3.0TR...	3IL3.0TR...	1.75	1.3	1.5			
1/2"	22	4.0	4IR4.0TR...	4IL4.0TR...	2.25	1.7	1.9	YI4	YE4	AVR.-4 (LH)
		5.0	4IR5.0TR...	4IL5.0TR...	2.75	2.1	2.5			
		6.0	4IR6.0TR...	4IL6.0TR...	3.50	2.3	2.7			
5/8"	27	6.0	5IR6.0TR...	5IL6.0TR...	3.50	2.3	2.7	YI5	YE5	AVR.-5 (LH)

## Coarse Pitch



Thread	Insert Size		Ordering Code	Dimensions mm			Toolholder		Min Bore dia.
	IC	L mm	RH / LH	h min	X	Y			mm
TR18x4	3/8"U	16	3UIR4.0TR...158/013	2.25	2.10	8.0	NVRC11-3U	156/020	14.0
TR20x4	3/8"	16	3IR4.0TR...158/012	2.25	1.53	1.9	NVRC13-3	156/006	16.0
TR22x5	3/8"U	16	3UIR5.0TR...158/011	2.75	1.56	8.0	NVRC14-3U	156/018	17.0
TR24x5			3UIR5.0TR...158/011	2.75	1.56	8.0	NVRC15-3U	156/019	19.0
TR26x5			3UIR5.0TR...158/011	2.75	1.56	8.0	NVRC15-3U	156/019	21.0
TR28x5			1/2"	22	4IR5.0TR...	2.75	2.30	2.7	NVRC20-4
TR30x6	1/2"U	22	4UIR6.0TR...158/007	3.50	1.94	11.0	NVRC20-4U	156/011	24.0
TR36x6	5/8"	27	5IR6.0TR...	3.50	2.30	2.7	NVRC25-5	156/012	30.0
TR38x7	1/2"U	22	4UIR7.0TR...158/008	4.00	2.27	11.0	NVRC25-4U	156/013	31.0
TR40x7			4UIR7.0TR...158/008	4.00	2.27	11.0	NVRC25-4U	156/013	33.0
TR42x7			4UIR7.0TR...158/008	4.00	2.27	11.0	NVRC32-4U	156/014	35.0
TR44x7			4UIR7.0TR...158/008	4.00	2.27	11.0	NVRC32-4U	156/014	37.0
TR46x8	5/8"U	27	5UIR8.0TR...158/010	4.50	2.59	13.5	NVRC32-5U	156/015	38.0
TR48x8			5UIR8.0TR...158/010	4.50	2.59	13.5	NVRC32-5U	156/015	40.0
TR50x8			5UIR8.0TR...158/010	4.50	2.59	13.5	NVRC32-5U	156/015	42.0
TR52x8			5UIR8.0TR...158/010	4.50	2.59	13.5	NVRC32-5U	156/015	44.0

Left Handed Tool Supplied by Request.

U Type Inserts Can be Used for Both LH and RH Applications.

## Trapez (con't)

### Internal

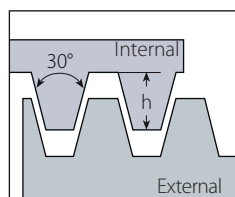

Defined by: DIN 103  
Tolerance class: 7e/7H

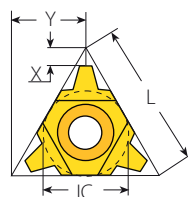

U Style

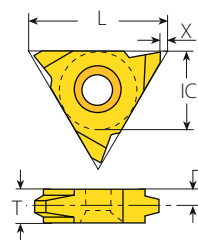

V Style

### U Style



Insert Size	Pitch	Ordering Code	Dimensions mm			Anvil		Toolholder	
			IC	L mm	mm	RH	LH		
1/2"U	22	4UI6.0TR...	6.0	3.50	2.0	11.0	YI4U	YE4U	AVR...-4U (LH)
		4UI7.0TR...	7.0	4.00	2.3	11.0			
		4UI8.0TR...	8.0	4.50	2.6	11.0			
5/8"U	27	5UI8.0TR...	8.0	4.50	2.6	13.7	YI5U	YE5U	AVR...-5U (LH)
		5UI9.0TR...	9.0	5.00	3.0	13.7			

### V Style



Insert Size	Pitch	Ordering Code	Dimensions mm						Toolholder	
			IC	L mm	mm	RH	LH	h min		X
5/8"V	27	5VIR6.0TR...	6.0	5VIR6.0TR...	5VIL6.0TR...	3.50	1.0	3.3	6	NVR...-5V (LH)
		5VIR7.0TR...	7.0	5VIR7.0TR...	5VIL7.0TR...	4.00	1.0	3.3	6	
		5VIR8.0TR...	8.0	5VIR8.0TR...	5VIL8.0TR...	4.50	1.0	3.3	6	
		5VIR9.0TR...	9.0	5VIR9.0TR...	5VIL9.0TR...	5.00	1.0	4.3	8	
		5VIR10.0TR...	10.0	5VIR10.0TR...	5VIL10.0TR...	5.50	1.0	4.3	8	
		5VIR12.0TR...	12.0	5VIR12.0TR...	5VIL12.0TR...	6.50	1.0	5.2	10	



### Internal

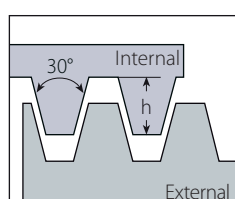

Defined by: DIN 103  
Tolerance class: 7e/7H

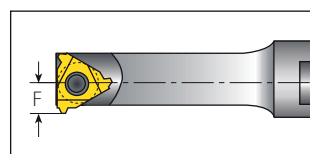
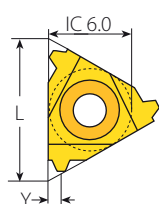

Mini-3

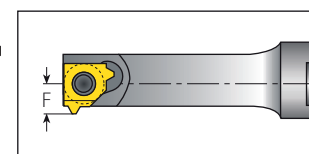
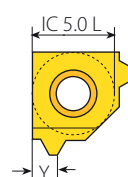

Mini-L

### Mini-3



Insert Size	Pitch	Ordering Code	Dimensions mm				Min. Bore dia.	Toolholder
			IC	L mm	mm	mm		
6.0	10	6.0IR1.5TR...	6.0	0.85	0.85	5.3	10.0	.NVR1...-6.0
		6.0IR2.0TR...	6.0	1.25	1.30	5.3	10.0	

### Mini-L



Insert Size	Pitch	Ordering Code	Dimensions mm				Min. Bore dia.	Toolholder
			IC mm	mm	mm	mm		
5.0L	1.5	5LIR1.5TR...	5.0L	0.85	0.85	4.65	8.0	.NVR 10...-5L
		5LIR2.0TR...	5.0L	1.25	1.30	4.65	8.0	

Left Handed Tool Supplied by Request. (Example: 6.0IL2.0TR...)

# American ACME

## External

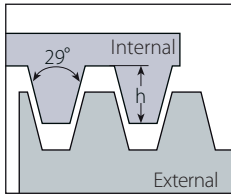

Defined by: ANSI B1.5:1988  
Tolerance class: 3G

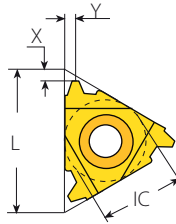

Standard

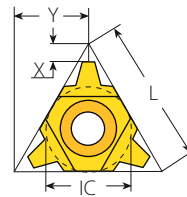

U Style

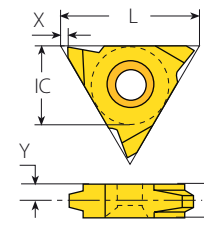

V Style

## Standard



Insert Size		Pitch	Ordering Code		Dimensions mm			Anvil		Toolholder
IC	L mm	tpi	RH	LH	h min	X	Y	RH	LH	
1/4"	11	16	2ER16ACME...	2EL16ACME...	0.92	1.0	1.1	-	-	NL...-2 (LH)
		16	3ER16ACME...	3EL16ACME...	0.92	1.0	1.1	YE3	YI3	AL...-3 (LH)
		14	3ER14ACME...	3EL14ACME...	1.03	1.0	1.2			
		12	3ER12ACME...	3EL12ACME...	1.19	1.1	1.2			
		10	3ER10ACME...	3EL10ACME...	1.52	1.3	1.4			
		8	3ER8ACME...	3EL8ACME...	1.84	1.4	1.5			
3/8"	16	7	3ER7ACME...	3EL7ACME...	2.08	1.9	2.2	YE3AC6	YI3AC6	AL...-3 (LH)
		6	3ER6ACME...	3EL6ACME...	2.37	1.7	1.9			
		7	4ER7ACME...	4EL7ACME...	2.08	1.9	2.2			
1/2"	22	6	4ER6ACME...	4EL6ACME...	2.37	1.8	2.1	YE4	YI4	AL...-4 (LH)
		5	4ER5ACME...	4EL5ACME...	2.79	2.0	2.3			
5/8"	27	4	5ER4ACME...	5EL4ACME...	3.43	2.4	2.7	YE5	YI5	AL...-5 (LH)

## U Style



Insert Size		Pitch	Ordering Code	Dimensions mm			Anvil		Toolholder
IC	L mm	tpi	RH+LH	h min	X	Y	RH	LH	
1/2"U	22	3	4UE3ACME...	4.49	3.0	11.0	YE4U	YI4U	AL...-4U (LH)
		4	4UE4ACME...	3.43	2.3	11.0			
5/8"U	27	3	5UE3ACME...	4.49	3.0	13.7	YE5U	YI5U	AL...-5U (LH)

## V Style



Insert Size		Pitch	Ordering Code		Dimensions mm				Toolholder
IC	L mm	tpi	RH	LH	h min	X	Y	T	
5/8"V	27	4	5VER4ACME...	5VEL4ACME...	3.43	1.0	3.3	6	NL...-5V-6 (LH)
		3.5	5VER3.5ACME...	5VEL3.5ACME...	3.85	1.0	3.3	6	
		3	5VER3ACME...	5VEL3ACME...	4.49	1.0	3.3	6	
		2	5VER2ACME...	5VEL2ACME...	6.60	1.0	5.2	10	NL...-5V-10 (LH)



## American ACME (con't)

### Internal

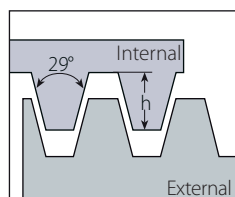

Defined by: ANSI B1.5:1988  
 Tolerance class: 3G

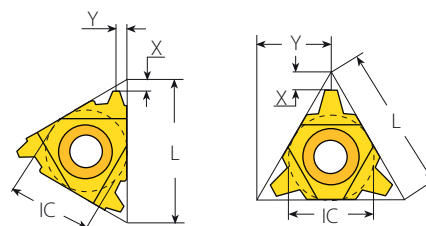

Standard

U Style

### Standard



Insert Size		Pitch	Ordering Code		Dimensions mm			Anvil		Toolholder
IC	L mm	tpi	RH	LH	h min	X	Y	RH	LH	
1/4"	11	16	2IR16ACME...	2IL16ACME...	0.92	0.9	0.9	-	-	NVR..-2 (LH)
		16	3IR16ACME...	3IL16ACME...	0.92	1.0	1.1			
3/8"	16	14	3IR14ACME...	3IL14ACME...	1.03	1.1	1.2	YI3	YE3	AVR..-3 (LH)
		12	3IR12ACME...	3IL12ACME...	1.19	1.2	1.3			
		10	3IR10ACME...	3IL10ACME...	1.52	1.2	1.3			
		8	3IR8ACME...	3IL8ACME...	1.84	1.4	1.5			
		6	3IR6ACME...	3IL6ACME...	2.37	1.7	1.9	YI3AC6	YE3AC6	
1/2"	22	6	4IR6ACME...	4IL6ACME...	2.37	1.8	2.1	YI4	YE4	AVR..-4 (LH)
		5	4IR5ACME...	4IL5ACME...	2.79	2.0	2.3			
5/8"	27	4	5IR4ACME...	5IL4ACME...	3.43	2.3	2.6	YI5	YE5	AVR..-5 (LH)

### Coarse Pitch



Thread	Insert Size		Ordering Code	Dimensions mm			Anvil	Min Bore dia.	
tpi	IC	L mm	RH / LH	h min	X	Y	RH	Toolholder	mm
1/2"x10	6.0U	10	6.0UIR10ACME...158/005	1.52	1.0	5.2	-	NVRC 8-6.0U 156/003	10.16
5/8"x8	1/4"U	11	2UIR8ACME...158/006	1.84	1.0	5.5	-	NVRC 10-2U 156/004	12.70
3/4"x6	3/8"	16	3IR6ACME...	2.37	1.7	1.8	-	NVRC 11-3 156/005	14.82
7/8"x6			3IR6ACME...	2.37	1.7	1.8	-	NVRC 13-3 156/006	18.42
1"x5	1/2"	22	4IR5ACME...	2.79	2.0	2.3	-	NVRC 17-4 156/007	20.32
1 1/8"x5			4IR5ACME...	2.79	2.0	2.3	-	NVRC 20-4 156/008	24.00
1 1/4"x5			4IR5ACME...	2.79	2.0	2.3	-	NVRC 20-4 156/009	27.18
1 1/2"x4	5/8"	27	5IR4ACME...	3.43	2.3	2.6	-	NVRC 28-5 156/010	32.38
1 3/4"x4			5IR4ACME...	3.43	2.3	2.6	YI5-1P	AVRC 32-5	38.74

Left Handed Tool Supplied by Request.

U Type Inserts Can Be Used for Both LH and RH Applications.

### U Style



Insert Size		Pitch	Ordering Code	Dimensions mm			Anvil		Toolholder
IC	L mm	tpi	RH+LH	h min	X	Y	RH	LH	
1/2"U	22	4	4UI4ACME...	3.43	2.3	11.0	YI4U	YE4U	AVR..-4U (LH)
		3	4UI3ACME...	4.49	2.9	11.0			
5/8"U	27	3	5UI3ACME...	4.49	2.9	13.7	YI5U	YE5U	AVR..-5U(LH)

## American ACME (con't)

### Internal

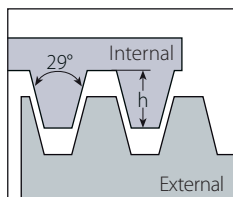

Defined by: ANSI B1.5:1988  
Tolerance class: 3G

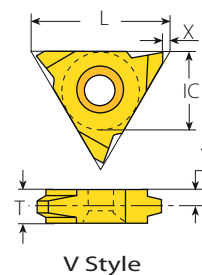

V Style

### V Style



Insert Size		Pitch	Ordering Code		Dimensions mm				Toolholder
IC	L mm	tpi	RH	LH	h min	X	Y	T	
5/8"V	27	4	5VIR4ACME...	5VIL4ACME...	3.43	1.0	3.3	6	NVR..-5V (LH)
		3.5	5VIR3.5ACME...	5VIL3.5ACME...	3.85	1.0	3.3	6	
		3	5VIR3ACME...	5VIL3ACME...	4.49	1.0	3.3	6	
		2	5VIR2ACME...	5VIL2ACME...	6.60	1.0	5.2	10	



### Internal

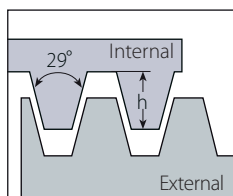

Defined by: ANSI B1.5:1988  
Tolerance class: 3G

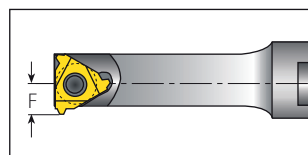
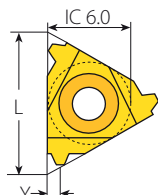

Mini-3

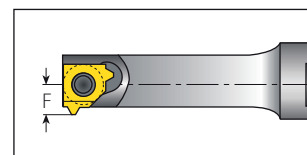
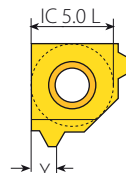

Mini-L

### Mini-3



Insert Size		Pitch	Ordering Code	Dimensions mm			Min. Bore dia.	Toolholder
IC	L mm	tpi	RH	h min	Y	F	mm	
6.0	10	12	6.0IR12ACME...	1.19	1.1	5.1	10.0	.NVR1..-6.0

### Mini-L



Insert Size	Pitch	Ordering Code	Dimensions mm			Min. Bore dia.	Toolholder
IC mm	tpi	RH	h min	Y	F	mm	
5.0L	12	5LIR12ACME...	1.19	1.1	4.42	8.0	.NVR10..-5L

Left Handed Tool Supplied by Request. (Example: 6.0IL12ACME...)

# Stub ACME

## External

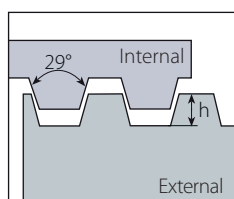

Defined by: ANSI B1.8:1988  
Tolerance class: 2G

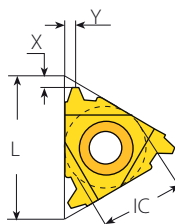

Standard

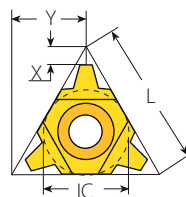

U Style

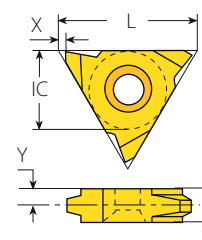

V Style

## Standard



Insert Size		Pitch	Ordering Code		Dimensions mm			Anvil		Toolholder
IC	L mm	tpi	RH	LH	h min	X	Y	RH	LH	
1/4"	11	16	2ER16STACME...	2EL16STACME...	0.60	1.0	1.0	-	-	NL..-2 (LH)
		16	3ER16STACME...	3EL16STACME...	0.60	1.0	1.0			
		14	3ER14STACME...	3EL14STACME...	0.67	1.1	1.1			
		12	3ER12STACME...	3EL12STACME...	0.76	1.2	1.2	YE3	YI3	AL..-3 (LH)
		10	3ER10STACME...	3EL10STACME...	1.02	1.2	1.3			
		8	3ER8STACME...	3EL8STACME...	1.21	1.4	1.5			
1/2"	22	6	4ER6STACME...	4EL6STACME...	1.52	1.7	1.8			
		5	4ER5STACME...	4EL5STACME...	1.78	2.1	2.3	YE4	YI4	AL..-4 (LH)
		4	4ER4STACME...	4EL4STACME...	2.16	2.3	2.3			
5/8"	27	4	5ER4STACME...	5EL4STACME...	2.16	2.3	2.4	YE5	YI5	AL..-5 (LH)
		3	5ER3STACME...	5EL3STACME...	2.79	2.9	2.9			

## U Style



Insert Size		Pitch	Ordering Code		Dimensions mm			Anvil		Toolholder
IC	L mm	tpi	RH+LH	h min	X	Y	RH	LH		
1/2"U	22	4	4UE4STACME...	2.16	2.6	11.0				
		3	4UE3STACME...	2.79	3.4	11.0	YE4U	YI4U	AL..-4U (LH)	

## V Style



Insert Size		Pitch	Ordering Code		Dimensions mm				Toolholder
IC	L mm	tpi	RH	LH	h min	X	Y	T	
5/8"V	27	4	5VER4STACME...	5VEL4STACME...	2.16	1.0	3.3	6	NL..-5V-6 (LH)
		3	5VER3STACME...	5VEL3STACME...	2.79	1.0	3.3	6	NL..-5V-6 (LH)
		2	5VER2STACME...	5VEL2STACME...	4.06	1.0	4.3	8	NL..-5V-8 (LH)

# Stub ACME (con't)

## Internal

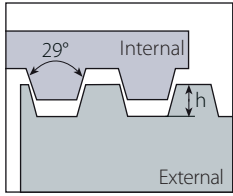

Defined by: ANSI B1.8:1988  
Tolerance class: 2G

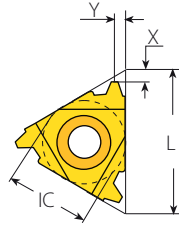

Standard

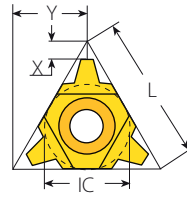

U Style

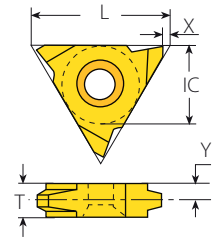

V Style

## Standard



Insert Size		Pitch	Ordering Code		Dimensions mm			Anvil		Toolholder
IC	L mm	tpi	RH	LH	h min	X	Y	RH	LH	
1/4"	11	16	2IR16STACME...	2IL16STACME...	0.60	1.0	1.0	-	-	NVR..-2 (LH)
		16	3IR16STACME...	3IL16STACME...	0.60	1.0	1.0			
		14	3IR14STACME...	3IL14STACME...	0.67	1.1	1.1			
		12	3IR12STACME...	3IL12STACME...	0.76	1.1	1.2	YI3	YE3	AVR..-3 (LH)
		10	3IR10STACME...	3IL10STACME...	1.02	1.2	1.3			
		8	3IR8STACME...	3IL8STACME...	1.21	1.4	1.5			
1/2"	22	6	4IR6STACME...	4IL6STACME...	1.52	1.7	1.8			
		5	4IR5STACME...	4IL5STACME...	1.78	2.1	2.3	YI4	YE4	AVR..-4 (LH)
		4	4IR4STACME...	4IL4STACME...	2.16	2.3	2.3			
5/8"	27	4	5IR4STACME...	5IL4STACME...	2.16	2.3	2.4			
		3	5IR3STACME...	5IL3STACME...	2.79	2.9	2.9	YI5	YE5	AVR..-5 (LH)

## U Style



Insert Size		Pitch	Ordering Code		Dimensions mm			Anvil		Toolholder
IC	L mm	tpi	RH+LH		h min	X	Y	RH	LH	
1/2"U	22	4	4UI4STACME...		2.16	2.5	11.0			
		3	4UI3STACME...		2.79	3.3	11.0	YI4U	YE4U	AVR..-4U (LH)

## V Style



Insert Size		Pitch	Ordering Code		Dimensions mm				Toolholder
IC	L mm	tpi	RH	LH	h min	X	Y	T	
5/8"V	27	4	5VIR4STACME...	5VIL4STACME...	2.16	1.0	3.3	6	
		3	5VIR3STACME...	5VIL3STACME...	2.79	1.0	3.3	6	NVR..-5V (LH)
		2	5VIR2STACME...	5VIL2STACME...	4.06	1.0	4.3	8	

# Stub ACME (con't)



## Internal

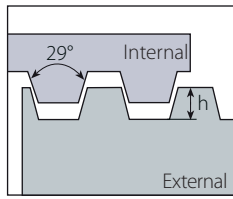

Defined by: ANSI B1.8:1988  
Tolerance class: 2G

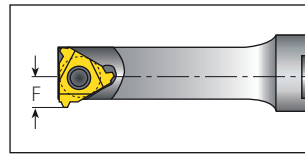
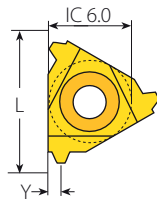

Mini-3

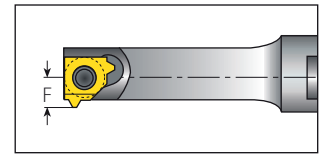
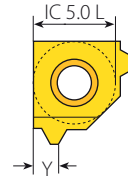

Mini-L

### Mini-3



Insert Size		Pitch	Ordering Code	Dimensions mm			Min. Bore dia.	
IC	L mm	tpi	RH	h min	Y	F	mm	Toolholder
6.0	10	12	6.0IR12STACME...	0.76	1.2	5.1	10.0	.NVR1.-6.0

### Mini-L



Insert Size		Pitch	Ordering Code	Dimensions mm			Min. Bore dia.	
IC mm	tpi		RH	h min	Y	F	mm	Toolholder
5.0L	12		5LIR12STACME...	0.76	1.2	4.42	8.0	.NVR 10. -5L

Left Handed Tool Supplied by Request. (Example: 6.0L12STACME...)

# UNJ - UNJC, UNJF, UNJEF, UNJS

## External

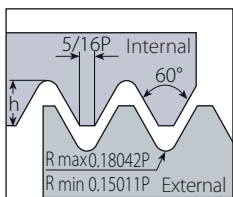

Defined by: MIL-S-8879C  
Tolerance class: 3A/3B

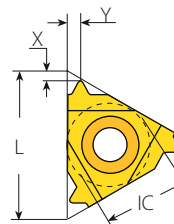

Standard

## Standard

Insert Size		Pitch	Ordering Code		Dimensions mm			Anvil		Toolholder					
IC	L mm	tpi	RH	LH	h min	X	Y	RH	LH						
1/4"	11	48	2ER48UNJ...	2EL48UNJ...	0.31	0.6	0.5	-	-	NL...-2 (LH)					
		44	2ER44UNJ...	2EL44UNJ...	0.33	0.6	0.6								
		40	2ER40UNJ...	2EL40UNJ...	0.37	0.6	0.6								
		36	2ER36UNJ...	2EL36UNJ...	0.41	0.6	0.6								
		32	2ER32UNJ...	2EL32UNJ...	0.46	0.6	0.7								
		28	2ER28UNJ...	2EL28UNJ...	0.52	0.7	0.7								
		24	2ER24UNJ...	2EL24UNJ...	0.61	0.7	0.8								
		20	2ER20UNJ...	2EL20UNJ...	0.73	0.8	0.9								
		18	2ER18UNJ...	2EL18UNJ...	0.81	0.8	1.0								
		16	2ER16UNJ...	2EL16UNJ...	0.92	0.9	1.1								
		14	2ER14UNJ...	2EL14UNJ...	1.05	1.0	1.2								
		3/8"	16	48	3ER48UNJ...	3EL48UNJ...	0.31				0.6	0.5	YE3	Y13	AL...-3 (LH)
				44	3ER44UNJ...	3EL44UNJ...	0.33				0.6	0.6			
				40	3ER40UNJ...	3EL40UNJ...	0.37				0.6	0.6			
36	3ER36UNJ...			3EL36UNJ...	0.41	0.6	0.6								
32	3ER32UNJ...			3EL32UNJ...	0.46	0.6	0.7								
28	3ER28UNJ...			3EL28UNJ...	0.52	0.7	0.7								
24	3ER24UNJ...			3EL24UNJ...	0.61	0.7	0.8								
20	3ER20UNJ...			3EL20UNJ...	0.73	0.8	0.9								
18	3ER18UNJ...			3EL18UNJ...	0.81	0.8	1.0								
16	3ER16UNJ...			3EL16UNJ...	0.92	0.9	1.1								
14	3ER14UNJ...			3EL14UNJ...	1.05	1.0	1.2								
13	3ER13UNJ...			3EL13UNJ...	1.13	1.0	1.3								
12	3ER12UNJ...			3EL12UNJ...	1.22	1.1	1.3								
11	3ER11UNJ...			3EL11UNJ...	1.33	1.2	1.5								
10	3ER10UNJ...	3EL10UNJ...	1.47	1.2	1.5										
9	3ER9UNJ...	3EL9UNJ...	1.63	1.3	1.7										
8	3ER8UNJ...	3EL8UNJ...	1.83	1.2	1.6										



Continued on next page ▶

## UNJ - UNJC, UNJF, UNJEF, UNJS (con't)

### External

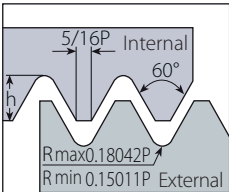

Defined by: MIL-S-8879C  
Tolerance class: 3A/3B

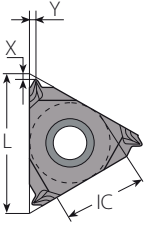

**SCB**  
Sintered  
Chipbreaker

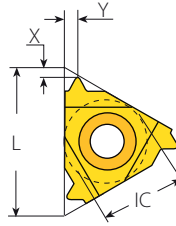

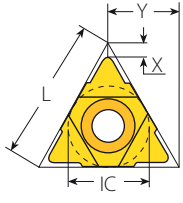

**Standard**

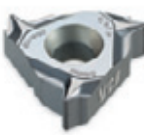

**U Style**

### Standard (con't)

Insert Size		Pitch	Ordering Code		Dimensions mm			Anvil		Toolholder	
IC	L mm	tpi	RH	LH	h min	X	Y	RH	LH		
 SCB	3/8" SCB	16	36	3JER36UNJ...		0.41	1.3	0.5	YE3	-	AL..-3
			32	3JER32UNJ...		0.46	1.2	0.5			
			28	3JER28UNJ...		0.52	0.7	0.8			
			24	3JER24UNJ...		0.61	0.7	0.8			
			20	3JER20UNJ...		0.73	0.7	0.8			
			18	3JER18UNJ...		0.81	0.7	0.8			
			16	3JER16UNJ...		0.92	0.8	0.8			
			14	3JER14UNJ...		1.05	1.3	1.5			
			12	3JER12UNJ...		1.22	1.3	1.5			
			10	3JER10UNJ...		1.47	1.3	1.5			
 Standard	1/2"	22	7	4ER7UNJ...	4EL7UNJ...	2.09	1.7	2.3	YE4	Y14	AL..-4 (LH)
			6	4ER6UNJ...	4EL6UNJ...	2.44	1.7	2.3			
			5	4ER5UNJ...	4EL5UNJ...	2.93	1.8	2.5			
 U Style	5/8"	27	4.5	5ER4.5UNJ...	5EL4.5UNJ...	3.26	2.0	2.7	YE5	Y15	AL..-5 (LH)
			4	5ER4UNJ...	5EL4UNJ...	3.67	2.2	3.1			

### U Style

Insert Size		Pitch	Ordering Code	Dimensions mm			Anvil		Toolholder	
IC	L mm	tpi	RH+LH	h min	X	Y	RH	LH		
 U Style	1/2"U	22	4.5	4UE4.5UNJ...	3.26	2.1	11.0	YE4U	Y14U	AL..-4U (LH)
			4	4UE4UNJ...	3.67	2.2	11.0			

# UNJ - UNJC, UNJF, UNJEF, UNJS (con't)

## Internal

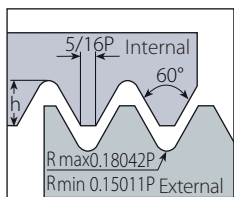

Defined by: MIL-S-8879C  
Tolerance class: 3A/3B

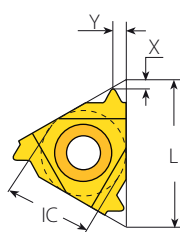

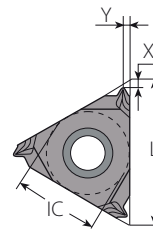

Standard



SCB  
Sintered  
Chipbreaker

## Standard

Insert Size		Pitch	Ordering Code		Dimensions mm			Anvil		Toolholder	
IC	L mm	tpi	RH	LH	h min	X	Y	RH	LH		
	1/4"	11	48	2IR48UNJ...	2IL48UNJ...	0.28	0.6	0.5	-	-	NVR..-2 (LH)
			44	2IR44UNJ...	2IL44UNJ...	0.30	0.6	0.6			
			40	2IR40UNJ...	2IL40UNJ...	0.33	0.6	0.6			
			36	2IR36UNJ...	2IL36UNJ...	0.37	0.6	0.6			
			32	2IR32UNJ...	2IL32UNJ...	0.42	0.6	0.7			
			28	2IR28UNJ...	2IL28UNJ...	0.47	0.7	0.7			
			24	2IR24UNJ...	2IL24UNJ...	0.55	0.7	0.8			
			20	2IR20UNJ...	2IL20UNJ...	0.66	0.8	0.9			
			18	2IR18UNJ...	2IL18UNJ...	0.74	0.8	1.0			
			16	2IR16UNJ...	2IL16UNJ...	0.83	0.9	1.1			
 SCB	1/4" SCB	11	36	2JIR36UNJ...		0.37	1.1	0.5	-	-	NVR..-2
			32	2JIR32UNJ...		0.42	1.2	0.5			
			28	2JIR28UNJ...		0.47	0.6	0.8			
			24	2JIR24UNJ...		0.55	0.6	0.8			
			20	2JIR20UNJ...		0.66	0.6	0.8			
			18	2JIR18UNJ...		0.74	0.6	0.8			
			16	2JIR16UNJ...		0.83	0.6	0.8			
			14	2JIR14UNJ...		0.95	0.6	0.8			

Continued on next page ▶



# UNJ - UNJC, UNJF, UNJEF, UNJS (con't)

## Internal

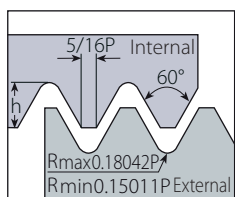

Defined by: MIL-S-8879C  
Tolerance class: 3A/3B

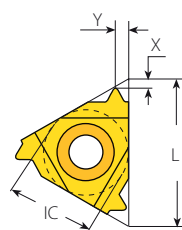

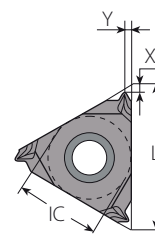

Standard

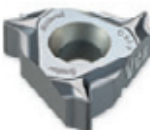

SCB  
Sintered  
Chipbreaker

## Standard (con't)

Insert Size		Pitch	Ordering Code		Dimensions mm			Anvil		Toolholder	
IC	L mm	tpi	RH	LH	h min	X	Y	RH	LH		
	3/8"	16	48	3IR48UNJ...	3IL48UNJ...	0.28	0.6	0.5	Y13	YE3	AVR..-3 (LH)
			44	3IR44UNJ...	3IL44UNJ...	0.30	0.6	0.6			
			40	3IR40UNJ...	3IL40UNJ...	0.33	0.6	0.6			
			36	3IR36UNJ...	3IL36UNJ...	0.37	0.6	0.6			
			32	3IR32UNJ...	3IL32UNJ...	0.42	0.6	0.7			
			28	3IR28UNJ...	3IL28UNJ...	0.47	0.7	0.7			
			24	3IR24UNJ...	3IL24UNJ...	0.55	0.7	0.8			
			20	3IR20UNJ...	3IL20UNJ...	0.66	0.8	0.9			
			18	3IR18UNJ...	3IL18UNJ...	0.74	0.8	1.0			
			16	3IR16UNJ...	3IL16UNJ...	0.83	0.9	1.1			
			14	3IR14UNJ...	3IL14UNJ...	0.95	1.0	1.2			
			13	3IR13UNJ...	3IL13UNJ...	1.02	1.0	1.3			
			12	3IR12UNJ...	3IL12UNJ...	1.11	1.1	1.3			
			11	3IR11UNJ...	3IL11UNJ...	1.21	1.2	1.5			
			10	3IR10UNJ...	3IL10UNJ...	1.33	1.2	1.5			
			9	3IR9UNJ...	3IL9UNJ...	1.48	1.3	1.7			
8	3IR8UNJ...	3IL8UNJ...	1.66	1.2	1.6						
	3/8" SCB	16	28	3JIR28UNJ...		0.47	0.6	0.8	Y13	-	AVR..-3
			24	3JIR24UNJ...		0.55	0.6	0.8			
			20	3JIR20UNJ...		0.66	0.6	0.8			
			18	3JIR18UNJ...		0.74	0.6	0.8			
			16	3JIR16UNJ...		0.83	0.6	0.8			
14	3JIR14UNJ...		0.95	1.1	1.5						
12	3JIR12UNJ...		1.11	1.1	1.5						
10	3JIR10UNJ...		1.33	1.1	1.5						
8	3JIR8UNJ...		1.66	1.0	1.5						
	1/2"	22	7	4IR7UNJ...	4IL7UNJ...	1.90	1.7	2.3	Y14	YE4	AVR..-4 (LH)
			6	4IR6UNJ...	4IL6UNJ...	2.21	1.7	2.3			
			5	4IR5UNJ...	4IL5UNJ...	2.66	1.8	2.5			
5/8"	27	4.5	5IR4.5UNJ...	5IL4.5UNJ...	2.95	2.0	2.7	Y15	YE5	AVR..-5 (LH)	
		4	5IR4UNJ...	5IL4UNJ...	3.32	2.2	2.4				

## UNJ - UNJC, UNJF, UNJEF, UNJS (con't)

### Internal

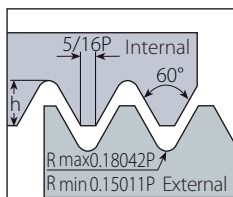

Defined by: MIL-S-8879C  
Tolerance class: 3A/3B

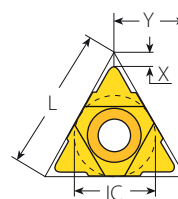

U Style

### U Style



Insert Size		Pitch	Ordering Code	Dimensions mm			Anvil		Toolholder
IC	L mm	tpi	RH+LH	h min	X	Y	RH	LH	
1/2"U	22	4.5	4UI4.5UNJ...	2.95	2.1	11.0	YI4U	YE4U	AVR..-4U (LH)
		4	4UI4UNJ...	3.32	2.2	11.0			

## UNJ - UNJC, UNJF, UNJEF, UNJS (con't)



### Internal

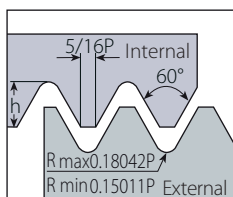

Defined by: MIL-S-8879C  
Tolerance class: 3A/3B

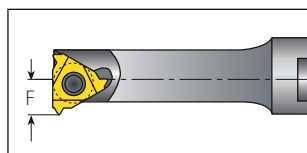
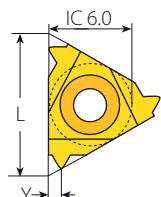

Mini-3

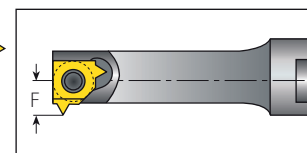
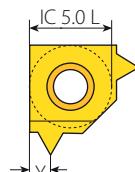

Mini-L

### Mini-3



Insert Size		Pitch	Ordering Code	Dimensions mm			Min. Bore dia.	Toolholder
IC	L mm	tpi	RH	h min	Y	F	mm	
6.0	10	20	6.0IR20UNJ...	0.66	0.9	4.90	9.8	.NVR1..-6.0

### Mini-L



Insert Size		Pitch	Ordering Code	Dimensions mm			Min. Bore dia.	Toolholder
IC mm		tpi	RH	h min	Y	F	mm	
5.0L		32	5LIR32UNJ...	0.42	0.6	3.92	7.5	.NVR 10. -5L
		28	5LIR28UNJ...	0.47	0.6	3.99	7.6	
		20	5LIR20UNJ...	0.66	0.9	4.21	7.8	
		18	5LIR18UNJ...	0.74	1.0	4.30	7.9	
		16	5LIR16UNJ...	0.83	1.0	4.41	8.0	
	14	5LIR14UNJ...	0.95	1.0	4.54	8.0		

Left Handed Tool Supplied by Request. (Example: 6.0IL20UNJ...)

# MJ

## External

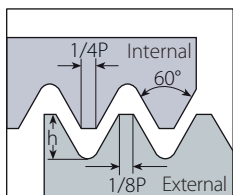

Defined by: ISO 5855  
Tolerance class: 4h/6h-4H/5H

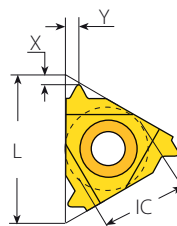

External - Standard

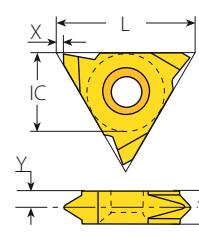

Slim Throat

## Standard



Insert Size		Pitch	Ordering Code		Dimensions mm			Anvil		Toolholder
IC	L mm	mm	RH	LH	h min	X	Y	RH	LH	
1/4"	11	1.0	2ER1.0MJ...	2EL1.0MJ...	0.58	0.7	0.7	-	-	NL..-2 (LH)
		1.25	2ER1.25MJ...	2EL1.25MJ...	0.72	0.8	0.9	-	-	
		1.5	2ER1.5MJ...	2EL1.5MJ...	0.87	0.8	1.0	-	-	
3/8"	16	0.7	3ER0.7MJ...	3EL0.7MJ...	0.40	0.6	0.6	YE3	YI3	AL..-3 (LH)
		1.0	3ER1.0MJ...	3EL1.0MJ...	0.58	0.7	0.7			
		1.25	3ER1.25MJ...	3EL1.25MJ...	0.72	0.8	0.9			
		1.5	3ER1.5MJ...	3EL1.5MJ...	0.87	0.8	1.0			
		2.0	3ER2.0MJ...	3EL2.0MJ...	1.15	1.0	1.3			
		2.5	3ER2.5MJ...	3EL2.5MJ...	1.49	1.1	1.5			
3.0	3ER3.0MJ...	3EL3.0MJ...	1.73	1.2	1.6					

## Slim Throat



Insert Size		Pitch	Ordering Code		Dimensions mm				Toolholder
IC	L mm	mm	RH	LH	h min	X	Y	T	
1/4"V	11	0.7	2VER0.7MJ	2VEL0.7MJ	0.40	0.7	2.5	3.2	NL..-2V (LH)
		0.8	2VER0.8MJ	2VEL0.8MJ	0.44	0.7	2.5	3.2	
		0.9	2VER0.9MJ	2VEL0.9MJ	0.53	0.7	2.6	3.2	
		1.0	2VER1.0MJ	2VEL1.0MJ	0.58	0.7	2.5	3.2	
		1.25	2VER1.25MJ	2VEL1.25MJ	0.72	0.7	2.3	3.2	
		1.5	2VER1.5MJ	2VEL1.5MJ	0.87	0.7	2.2	3.2	

# MJ

## Internal

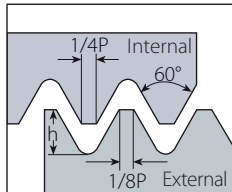

Defined by: ISO 5855  
Tolerance class: 4h/6h-4H/5H

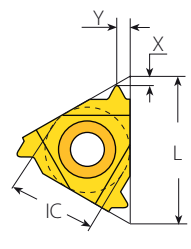

Internal - Standard

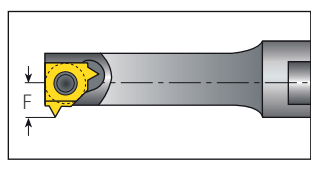
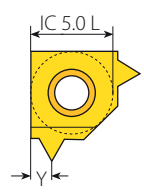

Mini-L

## Standard



Insert Size		Pitch	Ordering Code		Dimensions mm			Anvil		Toolholder
IC	L mm	mm	RH	LH	h min	X	Y	RH	LH	
1/4"	11	1.0	2IR1.0MJ...	2IL1.0MJ...	0.49	0.6	0.7	-	-	NVR..-2 (LH)
		1.25	2IR1.25MJ...	2IL1.25MJ...	0.61	0.8	0.9			
		1.5	2IR1.5MJ...	2IL1.5MJ...	0.73	0.8	1.0			
		2.0	2IR2.0MJ...	2IL2.0MJ...	0.97	0.8	1.0			
3/8"	16	0.75	3IR0.75MJ...	3IL0.75MJ...	0.37	0.6	0.6	Y13	YE3	AVR..-3 (LH)
		1.0	3IR1.0MJ...	3IL1.0MJ...	0.49	0.6	0.7			
		1.25	3IR1.25MJ...	3IL1.25MJ...	0.61	0.8	0.9			
		1.5	3IR1.5MJ...	3IL1.5MJ...	0.73	0.8	1.0			
		2.0	3IR2.0MJ...	3IL2.0MJ...	0.97	0.8	1.3			
		2.5	3IR2.5MJ...	3IL2.5MJ...	1.23	1.1	1.5			
3.0	3IR3.0MJ...	3IL3.0MJ...	1.46	1.2	1.6					

## Mini - L



Insert Size		Pitch	Ordering Code	Dimensions mm			Min. Bore Dia.	Toolholder
IC mm		mm	RH	h min	Y	F	mm	
5.0L		1.0	5LIR1.0MJ...	0.49	0.7	4.06	7.7	.NVR 10.-5L
		1.25	5LIR1.25MJ...	0.61	0.9	4.21	7.8	
		1.5	5LIR1.50MJ...	0.73	1.0	4.35	7.9	

# American Buttress

## External

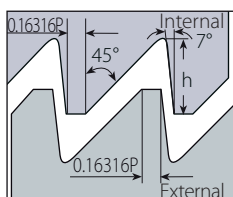

Defined by: ANSI B1.9.1973  
 Tolerance class: Class 2

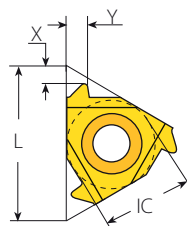

Standard

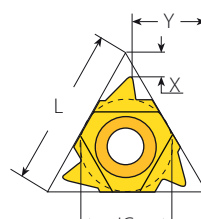

U Style

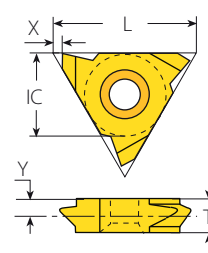

V Style

## Standard



Insert Size		Pitch	Ordering Code		Dimensions mm			Anvil		Toolholder
IC	L mm	tpi	RH	LH	h min	X	Y	RH	LH	
1/4"	11	20	2ER20ABUT...	2EL20ABUT...	0.84	1.0	1.4	-	-	NL..-2 (LH)
		16	2ER16ABUT...	2EL16ABUT...	1.05	1.3	1.9	-	-	
3/8"	16	20	3ER20ABUT...	3EL20ABUT...	0.84	1.0	1.4	YE3	YI3	AL..-3 (LH)
		16	3ER16ABUT...	3EL16ABUT...	1.05	1.3	1.9			
		12	3ER12ABUT...	3EL12ABUT...	1.40	1.4	2.0			
		10	3ER10ABUT...	3EL10ABUT...	1.68	1.5	2.3			
1/2"	22	8	4ER8ABUT...	4EL8ABUT...	2.10	2.0	3.2	YE4	YI4	AL..-4 (LH)
		6	4ER6ABUT...	4EL6ABUT...	2.80	2.2	3.5			

## U Style



Insert Size		Pitch	Ordering Code		Dimensions mm			Anvil		Toolholder
IC	L mm	tpi	RH	LH	h min	X	Y	RH	LH	
1/2"U	22	4	4UER4ABUT...	4UEL4ABUT...	4.21	2.4	9.8	YE4U-BUT4	YI4U-BUT4	AL..-4U (LH)
5/8"U	27	3	5UER3ABUT...	5UEL3ABUT...	5.61	3.1	12.1	YE5U-BUT3	YI5U-BUT3	AL..-5U (LH)

## V Style



Insert Size		Pitch	Ordering Code		Dimensions mm			Toolholder	
IC	L mm	tpi	RH	LH	h min	X	Y		T
5/8"V	27	4	5VER4ABUT...	5VEL4ABUT...	4.21	0.6	1.8	6	NL..-5V-6 (LH)
		3	5VER3ABUT...	5VEL3ABUT...	5.61	0.6	2.2	8	NL..-5V-8 (LH)
		2.5	5VER2.5ABUT...	5VEL2.5ABUT...	6.73	0.6	2.7	10	NL..-5V-10ABUT (LH)

# American Buttress (con't)

## Internal

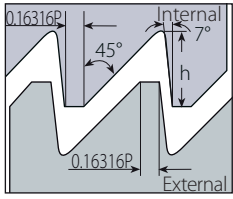

Defined by: ANSI B1.9.1973  
Tolerance class: Class 2

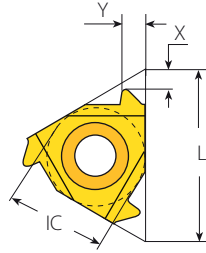

Standard

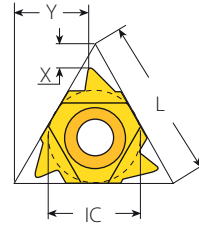

U Style

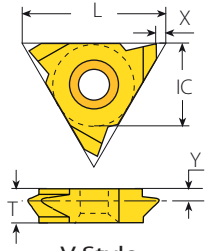

V Style

## Standard



Insert Size		Pitch	Ordering Code		Dimensions mm			Anvil		Toolholder
IC	L mm	tpi	RH	LH	h min	X	Y	RH	LH	
1/4"	11	20	2IR20ABUT...	2IL20ABUT...	0.84	1.0	1.4	-	-	NVR..-2 (LH)
		16	2IR16ABUT...	2IL16ABUT...	1.05	1.3	1.9	-	-	
3/8"	16	20	3IR20ABUT...	3IL20ABUT...	0.84	1.0	1.4	YI3	YE3	AVR..-3 (LH)
		16	3IR16ABUT...	3IL16ABUT...	1.05	1.3	1.9			
		12	3IR12ABUT...	3IL12ABUT...	1.40	1.4	2.0			
		10	3IR10ABUT...	3IL10ABUT...	1.68	1.5	2.3			
1/2"	22	8	4IR8ABUT...	4IL8ABUT...	2.10	2.0	3.2	YI4	YE4	AVR..-4 (LH)
		6	4IR6ABUT...	4IL6ABUT...	2.80	2.2	3.5			



## U Style



Insert Size		Pitch	Ordering Code		Dimensions mm			Anvil		Toolholder
IC	L mm	tpi	RH	LH	h min	X	Y	RH	LH	
1/2"U	22	4	4UIR4ABUT...	4UIL4ABUT...	4.21	2.4	9.8	YI4U-4B	YE4U-4B	AVR..-4U (LH)
5/8"U	27	3	5UIR3ABUT...	5UIL3ABUT...	5.61	3.1	12.1	YI5U-3B	YE5U-3B	AVR..-5U (LH)

## V Style



Insert Size		Pitch	Ordering Code		Dimensions mm			Toolholder	
IC	L mm	tpi	RH	LH	h min	X	Y		T
5/8"V	27	4	5VIR4ABUT...	5VIL4ABUT...	4.21	0.6	1.8	6	NVR..-5V (LH)
		3	5VIR3ABUT...	5VIL3ABUT...	5.61	0.6	2.2	8	
		2.5	5VIR2.5ABUT...	5VIL2.5ABUT...	6.73	0.6	2.7	10	

## British Buttress

### External

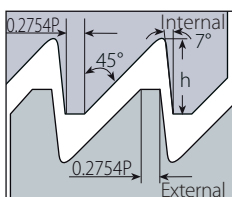

Defined by: B.S. 1657: 1950  
Tolerance class: Medium Class

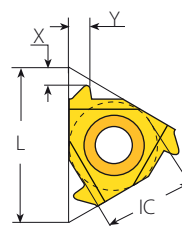

Standard

### Standard



Insert Size		Pitch	Ordering Code		Dimensions mm			Anvil		Toolholder
IC	L mm	tpi	RH	LH	h min	X	Y	RH	LH	
3/8"	16	16	3ER16BBUT...	3EL16BBUT...	0.80	1.1	1.6	YE3	YI3	AL..-3 (LH)
		12	3ER12BBUT...	3EL12BBUT...	1.07	1.4	2.1			
		10	3ER10BBUT...	3EL10BBUT...	1.28	1.4	2.2			
		8	3ER8BBUT...	3EL8BBUT...	1.61	1.6	2.5			
1/2"	22	8	4ER8BBUT...	4EL8BBUT...	1.61	1.6	2.5	YE4	YI4	AL..-4 (LH)

## British Buttress

### Internal

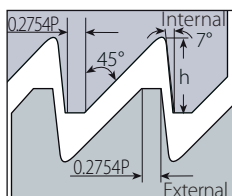

Defined by: B.S. 1657: 1950  
Tolerance class: Medium Class

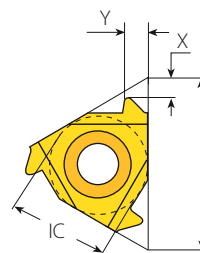

Standard

### Standard



Insert Size		Pitch	Ordering Code		Dimensions mm			Anvil		Toolholder
IC	L mm	tpi	RH	LH	h min	X	Y	RH	LH	
3/8"	16	16	3IR16BBUT...	3IL16BBUT...	0.80	1.1	1.6	YI3	YE3	AVR..-3 (LH)
		12	3IR12BBUT...	3IL12BBUT...	1.07	1.4	2.1			
		10	3IR10BBUT...	3IL10BBUT...	1.28	1.4	2.2			
		8	3IR8BBUT...	3IL8BBUT...	1.61	1.6	2.5			
1/2"	22	8	4IR8BBUT...	4IL8BBUT...	1.61	1.6	2.5	YI4	YE4	AVR..-4 (LH)

# Metric Buttress (Sägengewinde)

## External / Internal

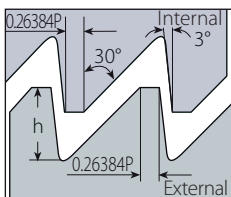

Defined by: DIN 513  
Tolerance class: Medium Class

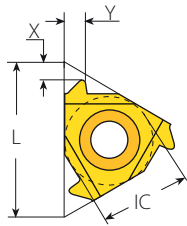

External Standard

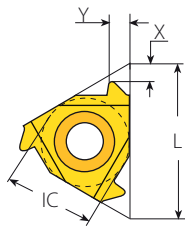

Internal Standard

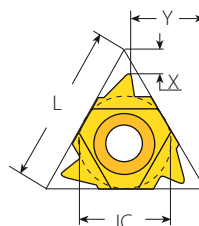

External U Style

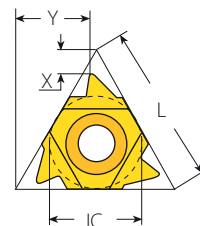

Internal U Style

## Standard - External



Insert Size		Pitch	Ordering Code		Dimensions mm			Anvil		Toolholder
IC	L mm	mm	RH	LH	h min	X	Y	RH	LH	
3/8"	16	2.0	3ER2.0SAGE...	3EL2.0SAGE...	1.74	1.5	2.1	YE3	YI3	AL..-3 (LH)
		2.0	4ER2.0SAGE...	4EL2.0SAGE...	1.74	1.5	2.1			
1/2"	22	3.0	4ER3.0SAGE...	4EL3.0SAGE...	2.60	1.8	2.6	YE4	YI4	AL..-4 (LH)
		4.0	4ER4.0SAGE...	4EL4.0SAGE...	3.55	1.75	3.1			
5/8"	27	4.0	5ER4.0SAGE...	5EL4.0SAGE...	3.55	1.9	3.2	YE5 082/038	YI5 082/039	AL..-5 (LH)

## U Style - External



Insert Size		Pitch	Ordering Code		Dimensions mm			Anvil		Toolholder
IC	L mm	mm	RH	LH	h min	X	Y	RH	LH	
1/2"U	22	5	4UER5.0SAGE...	4UEL5.0SAGE...	4.41	1.27	10.35	YE4U-SAGE5	YI4U-SAGE5	AL..-4U (LH)
		6	4UER6.0SAGE...	4UEL6.0SAGE...	5.29	1.25	10.28	YE4U-SAGE6	YI4U-SAGE6	

## Standard - Internal



Insert Size		Pitch	Ordering Code		Dimensions mm			Anvil		Toolholder
IC	L mm	mm	RH	LH	h min	X	Y	RH	LH	
3/8"	16	2.0	3IR2.0SAGE...	3IL2.0SAGE...	1.50	1.5	2.2	YI3	YE3	AVR..-3 (LH)
		3.0	4IR3.0SAGE...	4IL3.0SAGE...	2.25	1.7	2.9	YI4	YE4	AVR..-4 (LH)
1/2"	22	4.0	4IR4.0SAGE...	4IL4.0SAGE...	3.09	2.03	3.25			
5/8"	27	4.0	5IR4.0SAGE...	5IL4.0SAGE...	3.09	2.1	3.2	YI5 082/039	YE5 082/038	AVR..-5 (LH)

## U Style - Internal



Insert Size		Pitch	Ordering Code		Dimensions mm			Anvil		Toolholder
IC	L mm	mm	RH	LH	h min	X	Y	RH	LH	
1/2"U	22	5	4UIR5.0SAGE...	4UIL5.0SAGE...	3.76	1.8	10.3	YI4U-5S	YE4U-5S	AVR..-4U (LH)
		6	4UIR6.0SAGE...	4UIL6.0SAGE...	4.54	1.9	10.15	YI4U-6S	YE4U-6S	



# API

## External / Internal

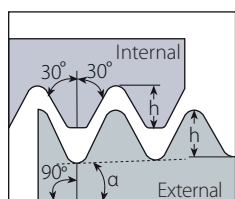

$$\alpha = \arctg (IPF/24)$$

Defined by: API SPEC. 7:1990  
Tolerance class: Standard API

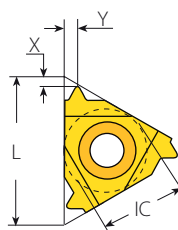

External - Standard

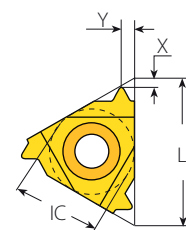

Internal - Standard

## Standard - External



Insert Size		Pitch	Thread	Taper	Ordering Code	Size	Dimensions mm			Anvil	
IC	L mm	tpi	IPF	RH			h min	X	Y	RH	Toolholder
1/2"	22	4	V-0.038R	2	4ER4API382...	NC23-NC50	3.09	2.1	2.8	YE4	AL..-4 (LH)
		4	V-0.038R	3	4ER4API383...	NC56-NC77	3.08	2.1	2.8		
		4	V-0.050	2	4ER4API502...	6 5/8" REG	3.75	2.0	2.9		
		4	V-0.050	3	4ER4API503...	5 1/2", 7 5/8", 8 5/8" REG	3.74	2.0	2.9		
		5	V-0.040	3	4ER5API403...	2 3/8"-4 1/2" REG	2.99	1.8	2.6		
		6	V-0.055	1.5	4ER6API551...	NC10-NC16	1.41	2.6	2.0		
5/8"	27	4	V-0.038R	2	5ER4API382...	NC23-NC50	3.09	2.1	2.8	YE5OIL	AL..-5 OIL (LH)
		4	V-0.038R	3	5ER4API383...	NC56-NC77	3.08	2.1	2.8		
		4	V-0.050	2	5ER4API502...	6 5/8" REG	3.75	2.1	3.1		
		4	V-0.050	3	5ER4API503...	5 1/2", 7 5/8", 8 5/8" REG	3.74	2.1	3.1		
		5	V-0.040	3	5ER5API403...	2 3/8"-4 1/2" REG	2.99	1.9	2.7		

## Standard - Internal



Insert Size		Pitch	Thread	Taper	Ordering Code	Size	Dimensions mm			Anvil	
IC	L mm	tpi	IPF	RH			h min	X	Y	RH	Toolholder
1/2"	22	4	V-0.038R	2	4IR4API382...	NC23-NC50	3.09	2.1	2.8	YI4	AVR..-4 (LH)
		4	V-0.038R	3	4IR4API383...	NC56-NC77	3.08	2.1	2.8		
		4	V-0.050	2	4IR4API502...	6 5/8" REG	3.75	2.1	3.1		
		4	V-0.050	3	4IR4API503...	5 1/2", 7 5/8", 8 5/8" REG	3.74	2.0	2.9		
		5	V-0.040	3	4IR5API403...	2 3/8"-4 1/2" REG	2.99	1.8	2.6		
		6	V-0.055	1.5	4IR6API551...	NC10-NC16	1.41	2.6	2.0		
5/8"	27	4	V-0.038R	2	5IR4API382...	NC23-NC50	3.09	2.1	2.8	YI5OIL	AVR..-5 OIL (LH)
		4	V-0.038R	3	5IR4API383...	NC56-NC77	3.08	2.1	2.8		
		4	V-0.050	2	5IR4API502...	6 5/8" REG	3.75	2.1	3.1		
		4	V-0.050	3	5IR4API503...	5 1/2", 7 5/8", 8 5/8" REG	3.74	2.1	3.1		
		5	V-0.040	3	5IR5API403...	2 3/8"-4 1/2" REG	2.99	1.9	2.7		

# API Buttress Casing

## External

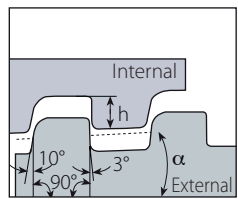

Defined by: STD.5B:1979  
Tolerance class: Standard API

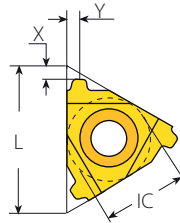

Standard

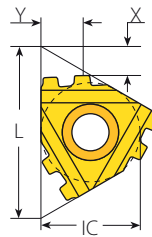

M+ Style

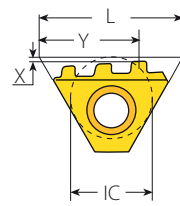

T+ Style

## Standard



Insert Size		Pitch	Taper	Ordering Code	Size	Dimensions mm			Anvil
IC	L mm	tpi	IPF	RH		h min	X	Y	RH Toolholder
1/2"	22	5	0.75	4ER5BUT75...	4 1/2"-13 3/8"	1.55	3.1	1.9	YE4 AL...-4
		5	1	4ER5BUT1...	16"-20"	1.55	3.1	1.9	

## M+ Style



Insert Size		Pitch	Taper	Teeth	Ordering Code	Size	Dimensions mm			Anvil
IC	L mm	tpi	IPF		RH		h min	X	Y	RH Toolholder
5/8"	27	5	0.75	2	5ER5BUT752M+...	4 1/2"-13 3/8"	1.55	4.8	6.8	YE5M AL...-5M

## T+ Style



Insert Size		Pitch	Taper	Teeth	Ordering Code	Size	Dimensions mm			Anvil
IC	L mm	tpi	IPF		RH		h min	X	Y	RH Toolholder
1/2"	22	5	0.75	3	4ER5BUT753T+...	4 1/2"-13 3/8"	1.55	0.1	16.1	Y4T AL...-4T

# API Buttress Casing

## Internal

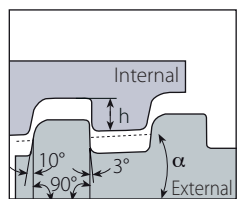

Defined by: STD.5B:1979  
Tolerance class: Standard API

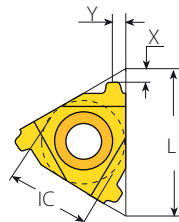

Standard

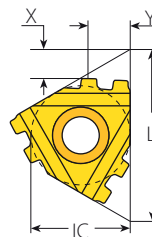

M+ Style

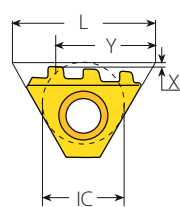

T+ Style

## Standard



Insert Size		Pitch	Taper	Ordering Code	Size	Dimensions mm			Anvil
IC	L mm	tpi	IPF	RH		h min	X	Y	RH Toolholder
1/2"	22	5	0.75	4IR5BUT75...	4 1/2"-13 3/8"	1.55	2.8	1.9	YI4 AVR...-4
		5	1	4IR5BUT1...	16"-20"	1.55	2.8	1.9	

## M+ Style



Insert Size		Pitch	Taper	Teeth	Ordering Code	Size	Dimensions mm			Anvil
IC	L mm	tpi	IPF		RH		h min	X	Y	RH Toolholder
5/8"	27	5	0.75	2	5IR5BUT752M+...	4 1/2"-13 3/8"	1.55	4.8	6.7	YI5M AVR...-5M

## T+ Style



Insert Size		Pitch	Taper	Teeth	Ordering Code	Size	Dimensions mm			Anvil
IC	L mm	tpi	IPF		RH		h min	X	Y	RH Toolholder
1/2"	22	5	0.75	3	4IR5BUT753T+...	4 1/2"-13 3/8"	1.55	0.1	16.1	Y4T AVR...-4T

# API Round Casing & Tubing

## External

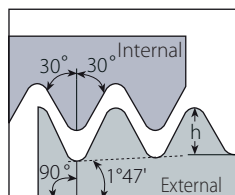

Defined by: API STD. 5B:1979  
Tolerance class: Standard API RD

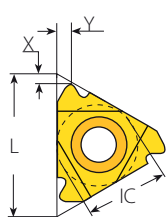

Standard

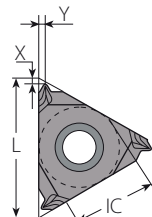

SCB  
Sintered  
Chipbreaker

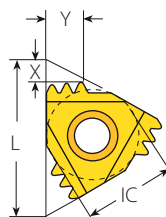

M+ Style

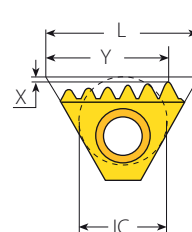

T+ Style

## Standard



SCB

Insert Size		Pitch	Ordering Code		Dimensions mm			Anvil	Toolholder
IC	L mm	tpi	RH		h min	X	Y	RH	Toolholder
3/8"	16	10	3ER10APIRD...		1.41	1.2	1.4	YE3	AL..-3
		8	3ER8APIRD...		1.81	1.3	1.5		
3/8" SCB	16	10	3JER10APIRD...		1.41	1.2	1.5	YE3	AL..-3
		8	3JER8APIRD...		1.81	1.3	1.5		

## M+ Style



Insert Size		Pitch	Teeth	Ordering Code		Dimensions mm			Anvil	Toolholder
IC	L mm	tpi		RH		h min	X	Y	RH	Toolholder
5/8"	27	10	3	5ER10APIRD3M+...		1.41	3.9	6.3	YE5M	AL..-5M
		8	2	5ER8APIRD2M+...		1.81	2.9	4.5		

## T+ Style



Insert Size		Pitch	Teeth	Ordering Code		Dimensions mm			Anvil	Toolholder
IC	L mm	tpi		RH		h min	X	Y	RH	Toolholder
1/2"T	22	10	6	4ER10APIRD6T+...		1.41	0.2	16.2	Y4T	AL..-4T
		8	3	4ER8APIRD3T+...		1.81	0.2	14.2		
		8	5	4ER8APIRD5T+...		1.81	0.2	16.7		

## API Round Casing & Tubing (con't)

### Internal

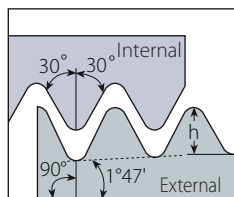

Defined by: API STD. 5B:1979  
Tolerance class: Standard API RD

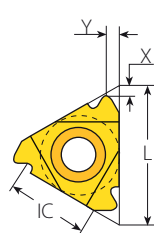

Standard

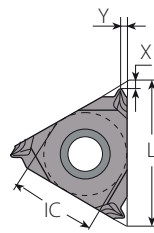

SCB  
Sintered  
Chipbreaker

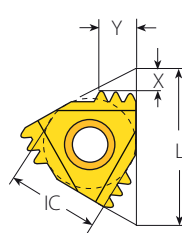

M+ Style

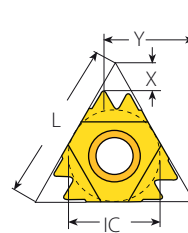

Z+ Style

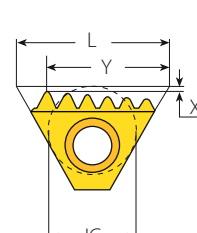

T+ Style

### Standard

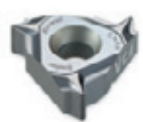

SCB

Insert Size		Pitch	Ordering Code	Dimensions mm			Anvil	Toolholder
IC	L mm	tpi	RH	h min	X	Y	RH	
3/8"	16	10	3IR10APIRD...	1.41	1.2	1.4	Y13	AVR..-3
		8	3IR8APIRD...	1.81	1.3	1.5		
3/8" SCB	16	10	3JIR10APIRD...	1.41	1.2	1.5	Y13	AVR..-3
		8	3JIR8APIRD...	1.81	1.3	1.5		

### M+ Style



Insert Size		Pitch	Teeth	Ordering Code	Dimensions mm			Anvil	Toolholder
IC	L mm	tpi		RH	h min	X	Y	RH	
1/2"	22	10	2	4IR10APIRD2M+...	1.41	2.4	3.7	Y14M	AVR..-4
		8	2	4IR8APIRD2M+...	1.81	2.9	4.5		
5/8"	27	10	3	5IR10APIRD3M+...	1.41	3.9	6.3	Y15M	AVR..-5M
		8	2	5IR8APIRD2M+...	1.81	2.9	4.5		

### Z+ Style



Insert Size		Pitch	Teeth	Ordering Code	Dimensions mm			Anvil	Toolholder
IC	L mm	tpi		RH	h min	X	Y	RH	
1/2"	22	8	2	4IR8APIRD2Z+...	1.81	3.7	9.6	Y14Z	AVR..-4Z

### T+ Style



Insert Size		Pitch	Teeth	Ordering Code	Dimensions mm			Anvil	Toolholder
IC	L mm	tpi		RH	h min	X	Y	RH	
1/2"	22	10	6	4IR10APIRD6T+...	1.43	0.2	16.8	Y4T	AVR..-4T
		8	3	4IR8APIRD3T+...	1.81	0.2	14.2		
		8	5	4IR8APIRD5T+...	1.81	0.2	16.7		

# VAM

## External / Internal

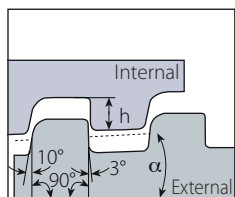

$\alpha = \arctg (IPF/24)$

Defined by: VAM  
Tolerance class: Standard VAM

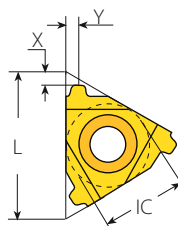

External - Standard

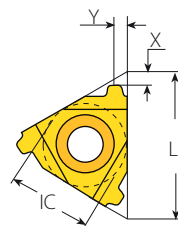

Internal - Standard

## Standard - External



Insert Size		Pitch	Taper	Ordering Code	Size	Dimensions mm			Anvil	Toolholder
IC	L mm	tpi	IPF	RH		h min	X	Y	RH	
3/8"	16	8	0.75	3ER8VAM...	2 3/8", 2 7/8"	0.97	1.7	1.8	YE3	AL...-3
1/2"	22	6	0.75	4ER6VAM...	3 1/2"	0.97	2.4	2.4	YE4	AL...-4
		5	0.75	4ER5VAM...	5"-9 5/8"	1.54	2.4	2.7		

## Standard - Internal



Insert Size		Pitch	Taper	Ordering Code	Size	Dimensions mm			Anvil	Toolholder
IC	L mm	tpi	IPF	RH		h min	X	Y	RH	
3/8"	16	8	0.75	3IR8VAM...	2 3/8", 2 7/8"	0.97	1.7	1.8	YI3	AVR...-3
1/2"	22	6	0.75	4IR6VAM...	3 1/2"	0.97	2.5	2.5	YI4	AVR...-4
		5	0.75	4IR5VAM...	5"-9 5/8"	1.54	2.4	2.5		

# EL-Extreme Line

## External / Internal

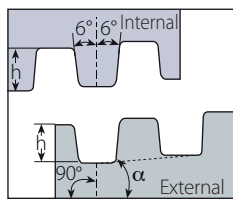

$\alpha = \arctg (IPF/24)$

Defined by: API STD,5B:1979  
Tolerance class: Standard

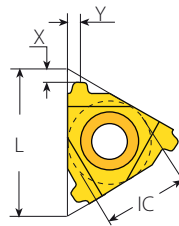

External - Standard

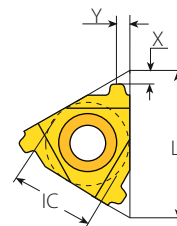

Internal - Standard

## Standard - External



Insert Size		Pitch	Taper	Ordering Code	Connection No. or Size	Dimensions mm			Anvil	
IC	L mm	tpi	IPF	RH		h min	X	Y	RH	Toolholder
1/2"	22	6	1.5	4ER6EL15...	5"-7 5/8"	1.21	1.9	1.9	YE4	AL...-4 (LH)
		5	1.25	4ER5EL125...	8 5/8"-10 3/4"	1.71	2.3	2.4		

## Standard - Internal



Insert Size		Pitch	Taper	Ordering Code	Connection No. or Size	Dimensions mm			Anvil	
IC	L mm	tpi	IPF	RH		h min	X	Y	RH	Toolholder
1/2"	22	6	1.5	4IR6EL15...	5"-7 5/8"	1.39	1.8	1.9	YI4	AVR...-4 (LH)
		5	1.25	4IR5EL125...	8 5/8"-10 3/4"	1.91	2.2	2.4		

# Hughes H-90

## External / Internal

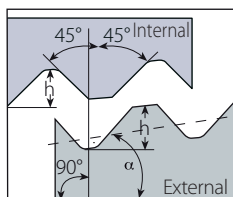

$$\alpha = \arctg (IPF/24)$$

Defined by: API STD,5B:1979  
Tolerance class: Standard

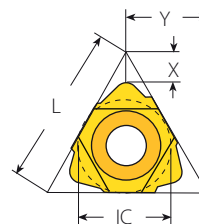

U Style

## U Style - External



Insert Size		Pitch	Taper	Ordering Code	Size	Dimensions mm			Anvil	
IC	L mm	tpi	IPF	RH		h min	X	Y	RH	Toolholder
1/2" U	22	3.5	2	4UER3.5H902...	3 1/2"-6 5/8"	2.50	4.2	11	YE4U-H90	AL...-4U (LH)
		3.5	3	4UER3.5H903...	7"-8 5/8"	2.50	4.2	11		
5/8" U	27	3	1.25*	5UER3H90SL...	2 3/8"-3 1/2"	2.24	5.5	13.7	YE5U-H90	AL...-5U (LH)

\* H-90 Slimline

## U Style - Internal



Insert Size		Pitch	Taper	Ordering Code	Size	Dimensions mm			Anvil	
IC	L mm	tpi	IPF	RH		h min	X	Y	RH	Toolholder
1/2" U	22	3.5	2	4UIR3.5H902...	3 1/2"-6 5/8"	2.50	4.2	11	YI4U-H90	AVR...-4U (LH)
		3.5	3	4UIR3.5H903...	7"-8 5/8"	2.50	4.2	11		
5/8" U	27	3	1.25*	5UIR3H90SL...	2 3/8"-3 1/2"	2.24	5.5	13.7	YI5U-H90	AVR...-5U (LH)

\* H-90 Slimline

# Pg

## External / Internal

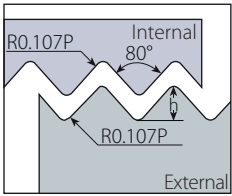

Defined by: DIN 40430  
Tolerance class: Standard

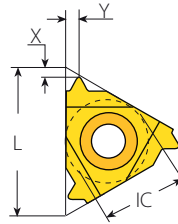

Standard External

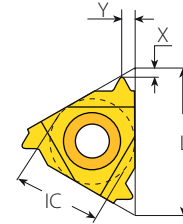

Standard Internal

### Standard - External



Insert Size		Pitch	Thread	Ordering Code		Dimensions mm			Anvil		Toolholder
IC	L mm	tpi		RH	LH	h min	X	Y	RH	LH	
1/4"	11	20	Pg7	2ER20PG...	2EL20PG...	0.61	0.8	0.9	-	-	NL..-2 (LH)
		18	Pg9/11/13.5/16	2ER18PG...	2EL18PG...	0.67	0.8	1.0	-	-	
		16	Pg21/29/36/42/48	2ER16PG...	2EL16PG...	0.76	0.9	1.1	-	-	
3/8"	16	20	Pg7	3ER20PG...	3EL20PG...	0.61	0.8	0.9	YE3	YI3	AL..-3 (LH)
		18	Pg9/11/13.5/16	3ER18PG...	3EL18PG...	0.67	0.8	1.0	YE3	YI3	
		16	Pg21/29/36/42/48	3ER16PG...	3EL16PG...	0.76	0.9	1.1	YE3	YI3	

### Standard - Internal



Insert Size		Pitch	Thread	Ordering Code		Dimensions mm			Anvil		Toolholder
IC	L mm	tpi		RH	LH	h min	X	Y	RH	LH	
1/4"	11	20	Pg7	2IR20PG...	2IL20PG...	0.64	0.8	0.9	-	-	NVR..-2 (LH)
		18	Pg9/11/13.5/16	2IR18PG...	2IL18PG...	0.67	0.8	1.0	-	-	
		16	Pg21/29/36/42/48	2IR16PG...	2IL16PG...	0.76	0.9	1.1	-	-	
3/8"	16	20	Pg7	3IR20PG...	3IL20PG...	0.64	0.8	0.9	YI3	YE3	AVR..-3 (LH)
		18	Pg11/13.5/16	3IR18PG...	3IL18PG...	0.67	0.8	1.0	YI3	YE3	
		16	Pg21/29/36/42/48	3IR16PG...	3IL16PG...	0.76	0.8	1.1	YI3	YE3	



# Pg



## Internal

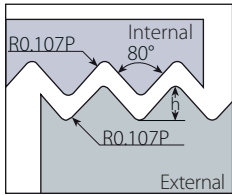

Defined by: DIN 40430  
Tolerance class: Standard

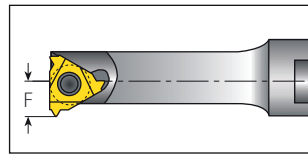
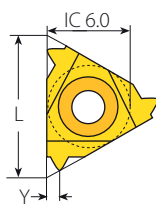

Mini-3

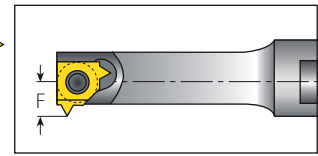
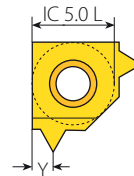

Mini-L

### Mini-3



Insert Size		Pitch	Thread	Ordering Code	Dimensions mm			Min. Bore dia.	Toolholder
IC	L mm	tpi		RH	h min	Y	F	mm	
6.0	10	20	Pg7	6.0IR20PG...	0.61	0.8	5.3	10.0	.NVR1..-6.0
		18	Pg9/11/13.5/16	6.0IR18PG...	0.67	0.9	5.3		

### Mini-L



Insert Size		Pitch	Thread	Ordering Code	Dimensions mm			Min. Bore dia.	Toolholder
IC		tpi		RH	h min	Y	F	mm	
5.0L		20	Pg7	5LIR20PG...	0.61	0.8	4.65	8.0	.NVR10..-5L
		18	Pg9/11/13.5/16	5LIR18PG...	0.67	0.9	4.65		





# Thread Turning

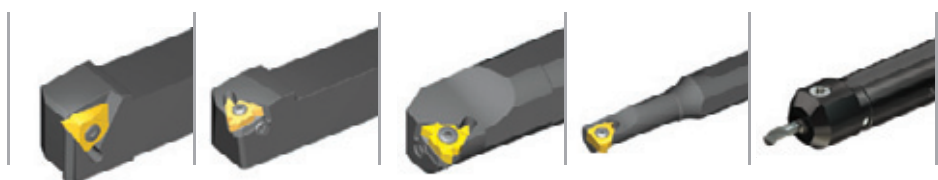

> Toolholders

# THREAD TURNING TOOLHOLDERS

■ VARDEX Ordering Code System.....	Page 99
------------------------------------	---------

## External Toolholders

■ Standard.....	Page 100
■ Standard with clamp.....	Page 101
■ API.....	Page 101
■ U style.....	Page 102
■ U style with clamp.....	Page 102
■ Slim Throat.....	Page 103
■ V style.....	Page 104
■ Z+ style.....	Page 104
■ M+ style.....	Page 105
■ T+ style.....	Page 105
■ Off-Set Qualified (FO).....	Page 106
■ Drop Head - Qualified (CQ).....	Page 106
■ Miniature Square Shank (External+Internal Toolholders).....	Page 107
■ Miniature Round Shank (External+Internal Toolholders).....	Page 107

## Internal Toolholders

■ Standard.....	Page 108
■ Standard for V6.....	Page 109
■ Standard for Coarse Pitch.....	Page 110
■ U style for Coarse Pitch.....	Page 110
■ Standard with clamp.....	Page 111
■ U style.....	Page 111
■ U style with clamp.....	Page 112
■ V style.....	Page 112
■ Z+ style.....	Page 113
■ M+ style.....	Page 113
■ T+ style.....	Page 114
■ API.....	Page 114
■ Standard with Carbide Shank.....	Page 115
■ Standard Kits.....	Page 116
■ Mini-3.....	Page 118
■ Mini-3-Adjustable.....	Page 118
■ Mini-L.....	Page 119
■ Mini-L-Adjustable.....	Page 119
■ Micro-Double Ended.....	Page 120
■ Micro-Single Ended.....	Page 121
■ Microscope Kits.....	Page 122
■ Spare Parts.....	Page 123

# Vardex Ordering Code System

## External Toolholders







<b>A</b>	<b>L</b>	<b>32</b>	<b>-</b>	<b>4</b>	<b>U</b>	<b>C</b>			
<b>1</b>	<b>2</b>	<b>3</b>		<b>4</b>	<b>5</b>	<b>6</b>	<b>7</b>	<b>8</b>	<b>9</b>

1 - Anvil
A - Anvil required N - No Anvil required O - Miniature holder

2 - Holder Style
L - External V - Miniature Square Shank VR - Miniature Round Shank

3 - Shank Square [mm]
8, 10, 12, 16, 20, 25, 32, 40, 50, 60

4 - Insert Size
2 - IC1/4" 3 - IC3/8" 4 - IC1/2" 5 - IC5/8"

5 - Insert Style
      <p>T+      Z+      M+</p> <p>U      V</p>

6 - Clamping
C - with Clamping

7 - Insert Width
(for IC5/8"V) 6, 8, 10

8 - Tool Type
CQ - Drop Head FQ - Off-Set Oil - For API Inserts

9 - RH/LH Holder
None - Right Hand LH - Left Hand

## Internal Toolholders

<b>C</b>	<b>A</b>	<b>VR</b>	<b>C</b>	<b>20</b>		<b>-</b>	<b>3</b>					
<b>1</b>	<b>2</b>	<b>3</b>	<b>4</b>	<b>5</b>	<b>6</b>		<b>7</b>	<b>8</b>	<b>9</b>	<b>10</b>	<b>11</b>	<b>12</b>

1 - Shank Type
B - Anti Vibration System C - Carbide Shank S - Mini Holders

2 - Anvil
A - Anvil required N - No Anvil required O - Miniature holder

3 - Tool Type
VR - Internal Round shank
4 - Cooling
C - With Coolant Channel

5 - Shank front Dia
10, 10D, 12, 13, 16 16D, 20, 25, 25D, 32, 40, 50 6.2 (Mini Adjust) 8.0 (Mini Adjust)

6 - Holder Length
(Mini Holders) U - Ultra Short S - Short M - Medium L - Long T - Adjustable

7 - Insert Size
5L - IC5.0L mm 4.0K - IC4.0 mm 6.0 - IC6.0 mm 2 - IC1/4" 3 - IC3/8" 4 - IC1/2" 5 - IC5/8"

8 - Insert style
U V T M Z L

9 - Clamping
C - with Clamp
10 - Oil Field
OIL - For API Inserts
11 - RH/LH Holder
None - Right Hand LH - Left Hand

12 - Serial No.
156/... (Coarse Pitch Holder) 206/... (V6 Holder)

## Micro, Microscope & Adjustable Toolholders (Sleeves)

<b>S</b>	<b>M</b>	<b>C</b>	<b>16</b>	<b>-</b>	<b>3</b>
<b>1</b>	<b>2</b>	<b>3</b>	<b>4</b>		<b>5</b>

1 - Holder Shape
S - Sleeve (Double Ended) M - Microscope (Single Ended)

2 - Holder Type
V - Adjustable Holders for Mini M - Micro (Double Ended) H - Microscope Holder (Single Ended)

3 - Cooling
C - Coolant Channel

4 - Holder Dia.
10, 12, 16, 20

5 - Holder Bore Size
Micro Size 3, 4, 5, 6, 7, 8, 10 Adjustable Holders (for Mini) 6.2 8

## External Toolholders

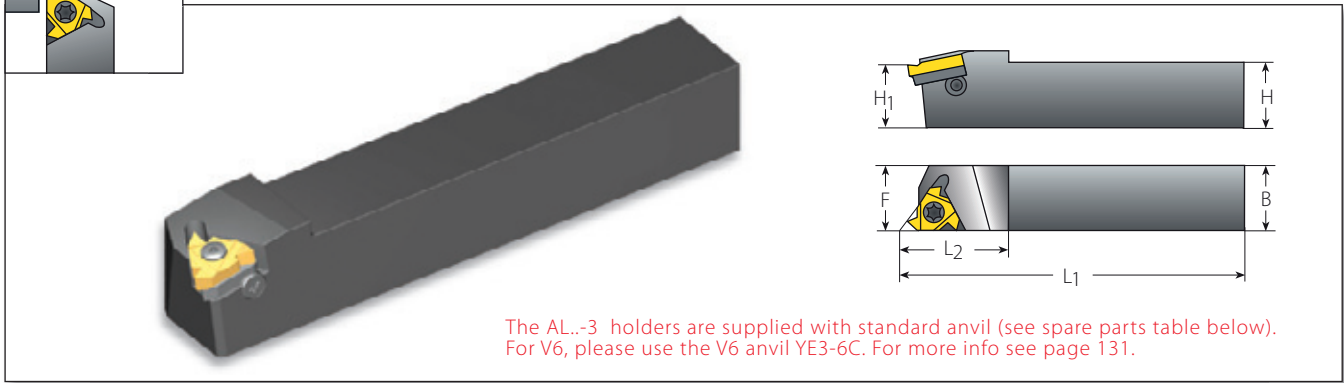

### Standard

### Spare Parts

Insert Size	Ordering Code	Dimensions mm										
		IC	RH/LH	H=H1=B	F	L1	L2	Insert Screw	Anvil Screw	Torx Key	Anvil RH	Anvil LH
1/4"	NL8-2			8	11	136.4	17.5					
	NL10-2			10	11	70	17.5	SN2T	-	K2T	-	-
	NL12-2			12	12	80	17.5					
3/8"	NL12-3			12	16	83.2	22	SA3T	-	K3T	-	-
	AL3/8-3			9.52	16	63.6	20.5					
	AL12-3			12	16	83.2	22					
	AL16-3			16	16	100.0	20.5					
	AL20-3			20	20	128.6	30	SA3T	SY3T	K3T	YE3	YI3
	AL25-3			25	25	153.6	30					
	AL32-3			32	32	173.6	30					
1/2"	AL25-4			25	25	155.7	36					
	AL32-4			32	32	175.7	36	SA4T	SY4T	K4T	YE4	YI4
	AL40-4			40	40	205.7	36					
5/8"	AL25-5			25	32	151.6	35					
	AL32-5			32	32	176.6	40					
	AL40-5			40	40	206.6	40	SA5T	SY5T	K5T	YE5	YI5
	AL50-5			50	50	256.6	40					

The above toolholders have a 1.5° helix angle. For other helix angles, see page 131. Toolholders with prefix "N" cannot be used with an anvil.

## External Toolholders

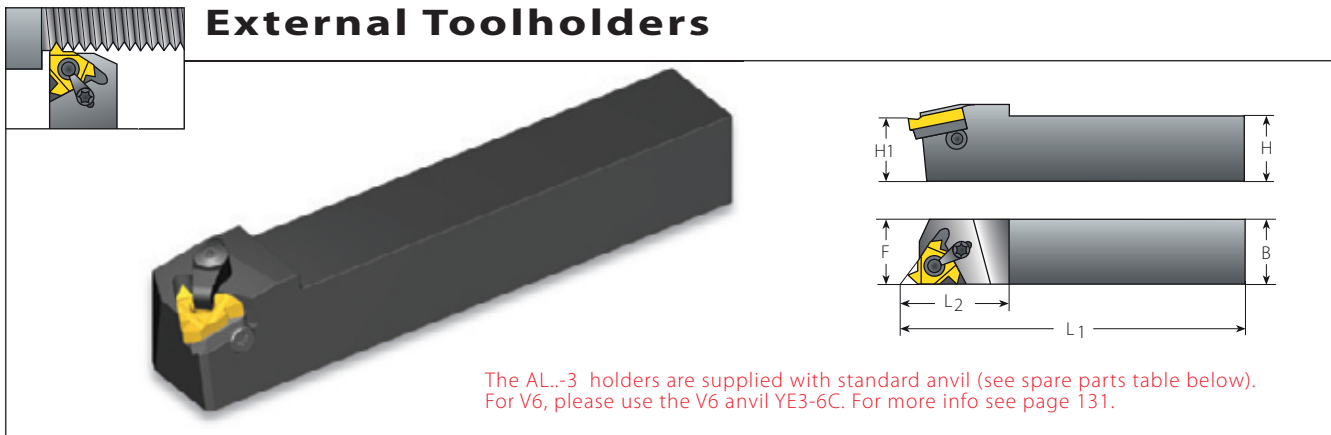

The AL..-3 holders are supplied with standard anvil (see spare parts table below). For V6, please use the V6 anvil YE3-6C. For more info see page 131.

### Standard with Clamp

(Dual System, Screw or Clamp)

#### Spare Parts

Insert Size	Ordering Code	Dimensions mm									
		IC	RH/LH	H=H1=B	F	L1	L2	Insert Screw	Anvil Screw	Clamp	Torx Key
3/8"	AL16-3C	16	16	100.0	20.5	SA3T	SY3T	C3	K3CT	YE3	YI3
	AL20-3C	20	20	128.6	30						
	AL25-3C	25	25	153.6	30						
	AL32-3C	32	32	173.6	30						
1/2"	AL25-4C	25	25	155.7	36	SA4T	SY4T	C4	K4T	YE4	YI4
	AL32-4C	32	32	175.7	36						
	AL40-4C	40	40	205.7	36						
5/8"	AL25-5C	25	32	151.6	35	SA5T	SY5T	C5	K5T	YE5	YI5
	AL32-5C	32	32	176.6	40						
	AL40-5C	40	40	206.6	40						
	AL50-5C	50	50	256.6	40						

## External Toolholders

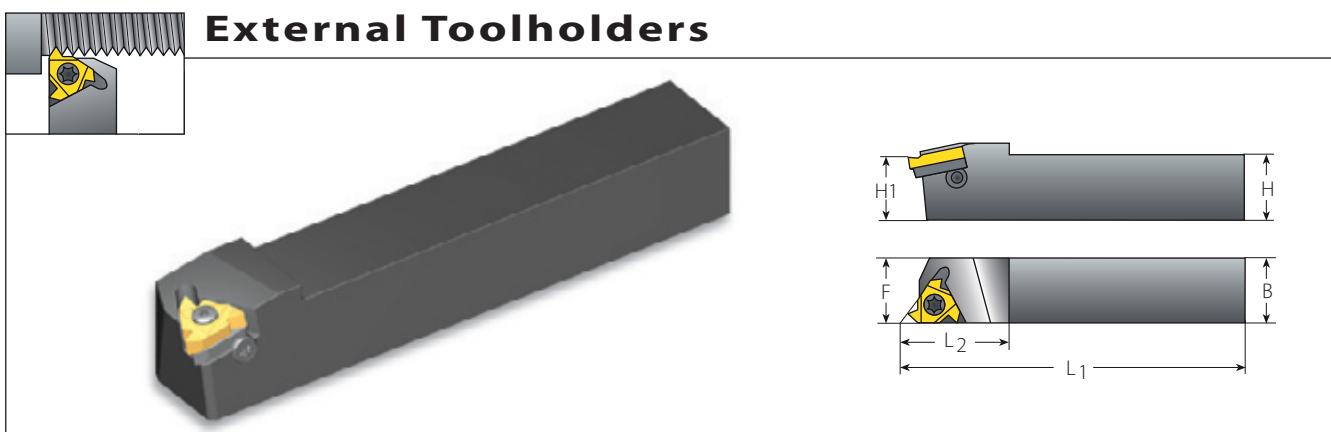

### Standard for API

#### Spare Parts

Insert Size	Ordering Code	Thread Form	Connection no. or size	Dimensions mm								
				IC	RH/LH	H=H1=B=F	L1	L2	Insert Screw	Anvil Screw	Torx Key	Anvil RH
5/8"	AL32-5OIL	V0.038R	V0.050	NC23-NC77 all sizes	32	175.9	40	SA5T	SY5T	K5T	YE5OIL	YI5OIL
	AL40-5OIL	V0.038R	V0.050	NC23-NC77 all sizes	40	205.9	40					

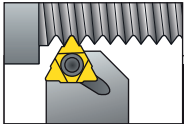

## External Toolholders

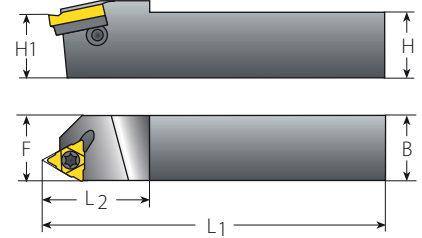
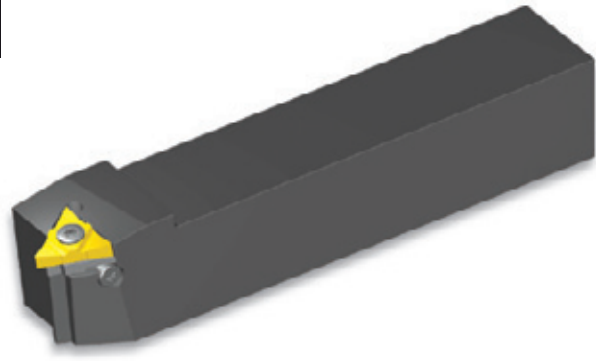

### U Style

Insert Size	Ordering Code	Dimensions mm			
IC	RH/LH	H=H1=B	F	L1	L2
1/2"U	AL25-4U	25	25	178.4	38
	AL32-4U	32	32	178.4	38
	AL40-4U	40	40	208.4	38
5/8"U	AL25-5U	25	25	179.1	40
	AL32-5U	32	32	179.1	40
	AL40-5U	40	40	209.1	40
	AL50-5U	50	50	259.1	40

### Spare Parts

Insert Screw	Anvil Screw	Torx Key	Anvil RH	Anvil LH
SA4T	SY4T	K4T	YE4U	YI4U
SA5T	SY5T	K5T	YE5U	YI5U

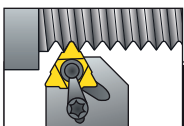

## External Toolholders

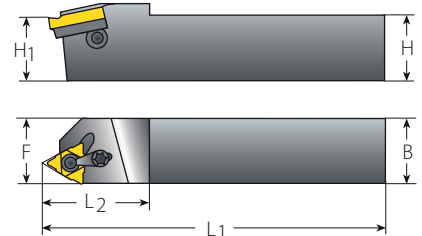
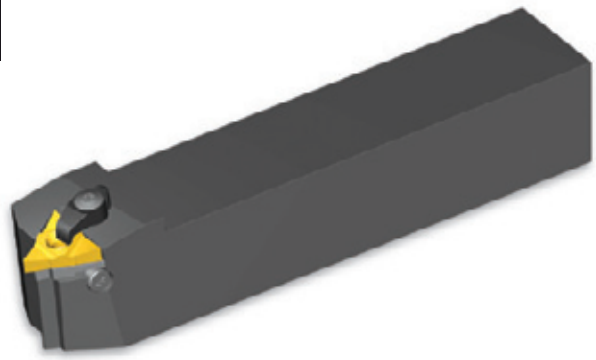

### U Style with Clamp

(Dual System, Screw or Clamp)

Insert Size	Ordering Code	Dimensions mm			
IC	RH/LH	H=H1=B	F	L1	L2
1/2"U	AL32-4UC	32	32	178.4	38
	AL40-4UC	40	40	208.4	38
5/8"U	AL32-5UC	32	32	179.1	40
	AL40-5UC	40	40	209.1	40
	AL50-5UC	50	50	259.1	40

### Spare Parts

Insert Screw	Anvil Screw	Clamp	Torx Key	Anvil RH	Anvil LH
SA4T	SY4T	C4	K4T	YE4U	YI4U
SA5T	SY5T	C5	K5T	YE5U	YI5U



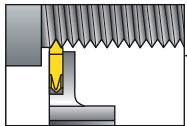

## External Toolholders

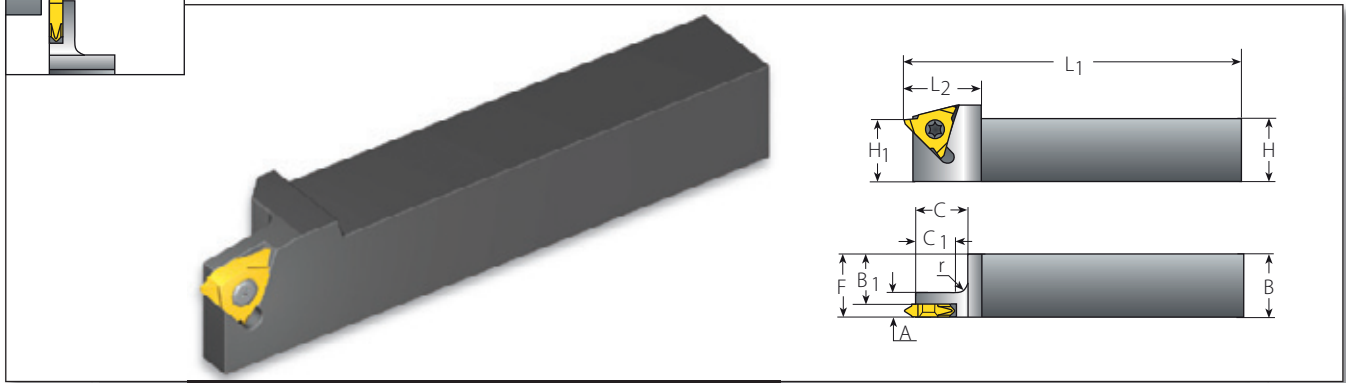

### Slim Throat

Spare Parts

Insert Size		Ordering Code	Dimensions mm								Spare Parts	
IC	RH/LH	H=B=F	H1	A	B1	C	C1	L1	L2	r	Insert Screw	Torx Key
1/4"V	NL8-2V	8	10	7	4.8	12.5	11.5	60	14.0	1	SN2T	K2T
	NL10-2V	10	10	7	6.8	12.5	11.5	70	14.0	1		
	NL12-2V	12	12	7	8.8	14.5	11.5	80	14.0	3		
	NL16-2V	16	16	7	12.8	14.5	11.5	100	14.0	3		
3/8"V	NL10-3V	10	14	7	6.4	14.5	11.5	70	18.5	3	SN3TV	K3T
	NL12-3V	12	14	7	8.4	14.5	11.5	80	18.5	3		
	NL16-3V	16	16	7	12.4	14.5	11.5	100	25.0	3		
	NL20-3V	20	20	7	16.4	16.5	11.5	125	30.0	3		
	NL25-3V	25	25	7	21.4	16.5	11.5	150	30.0	5		
	NL32-3V	32	32	7	28.4	16.5	11.5	170	30.0	5		
1/2"V	NL40-3V	40	40	7	36.4	16.5	11.5	200	30.0	5	SN4T	K4T
	NL25-4V	25	25	12	20.2	16.5	11.5	150	30.0	5		
	NL32-4V	32	32	12	27.2	16.5	11.5	170	30.0	5		
	NL40-4V	40	40	12	35.2	16.5	11.5	200	30.0	5		

All Slim Throat toolholders have a 1.5° helix angle.

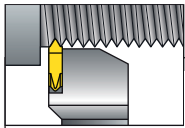

## External Toolholders

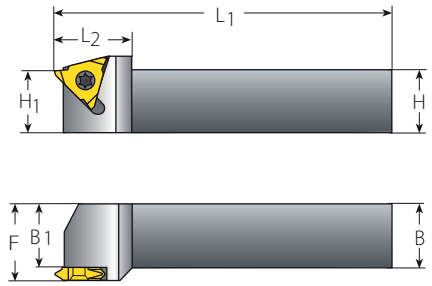
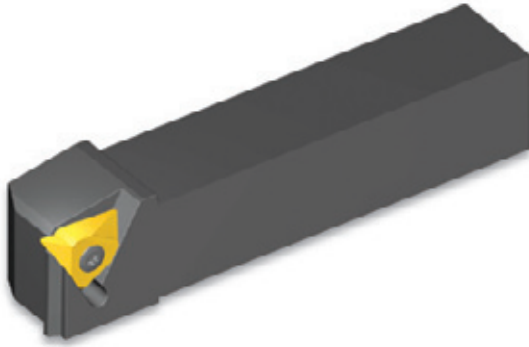

### V Style

Insert Size		Ordering Code		Dimensions mm			Spare Parts	
IC	RH/LH	H=H1=B	B1	F	L1	L2	Insert Screw	Torx key
5/8"V	NL32-5V-6	32	25.5	32.0	170	40	SN6T	K6T
	NL32-5V-8	32	25.5	34.1	170	40		
	NL32-5V-10	32	25.5	35.8	170	40		
	NL32-5V-10ABUT*	32	25.5	35.8	170	40		
	NL40-5V-6	40	33.5	40.0	200	40		
	NL40-5V-8	40	33.5	42.1	200	40		
	NL40-5V-10	40	33.5	43.8	200	40		
	NL40-5V-10ABUT*	40	33.5	43.8	200	40		

All V Style toolholders have a 1° helix angle.

The above toolholders are for RH inserts. For LH inserts, add LH to the toolholder's ordering code. (Example NL32-5V-6 **LH**)

\* To be used only with inserts 5VR2.5ABUT...

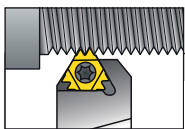

## External Toolholders

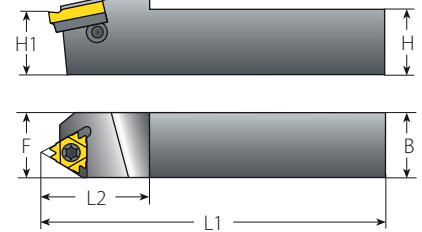
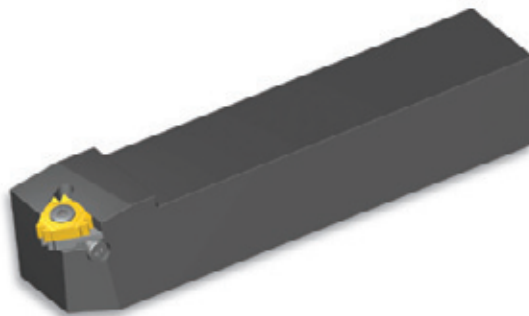

### Z+ Style

Insert Size		Ordering Code		Dimensions mm			Spare Parts				
IC	RH	H=H1=B	F	L1	L2	Insert Screw	Anvil Screw	Torx Key	Anvil RH	Anvil LH	
1/2"Z	AL32-4Z	32	32	178.4	38	SA4T	SY4T	K4T	YE4Z	YI4Z	
	AL40-4Z	40	40	208.4	38						
5/8"Z	AL32-5Z	32	32	179.1	40	SA5T	SY5T	K5T	YE5Z	YI5Z	
	AL40-5Z	40	40	209.1	40						
	AL50-5Z	50	50	259.1	40						

All Z Style toolholders have a 1.5° helix angle.



## External Toolholders

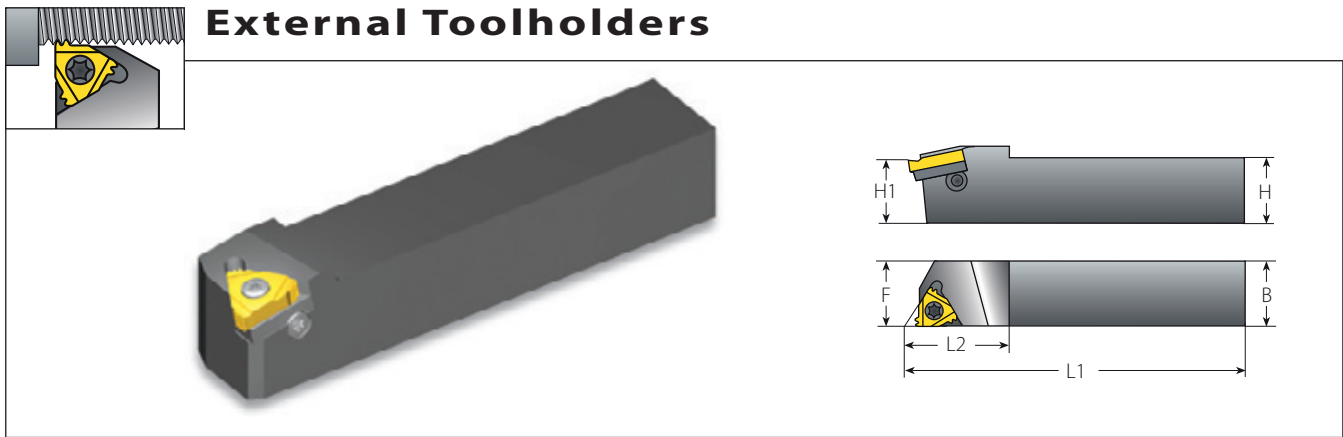

### M+ Style

Insert Size	Ordering Code	Dimensions mm			
IC	RH	H=H1=B	F	L1	L2
5/8" M	AL32-5M	32	32	176.6	40
	AL40-5M	40	40	206.6	40
	AL50-5M	50	50	256.6	40

### Spare Parts



Insert Screw	Anvil Screw	Torx Key	Anvil RH	Anvil LH
SA5T	SY5T	K5T	YE5M	YI5M

All M Style toolholders have a 1.5° helix angle.

## External Toolholders

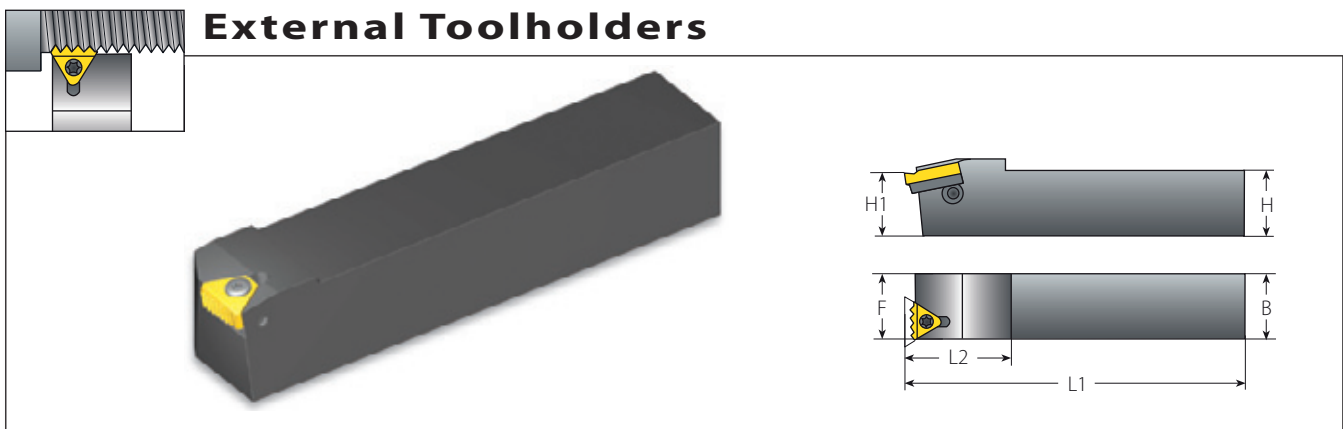

### T+ Style

Insert Size	Ordering Code	Dimensions mm			
IC	RH	H=H1=B	F	L1	L2
1/2" T	AL25-4T	25	27	150	30
	AL32-4T	32	34	170	30
	AL40-4T	40	42	200	30

### Spare Parts



Insert Screw	Anvil Screw	Insert Torx Key	Anvil Torx Key	Anvil RH/LH
SA4T	SY4K2	K4T	K2	Y4T

All T Style toolholders have a 0° helix angle.

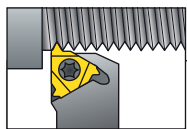

## External Toolholders

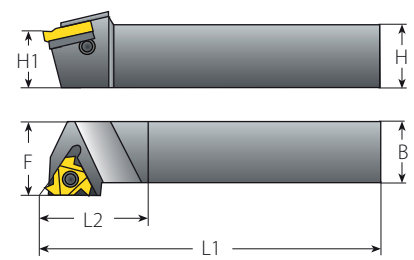
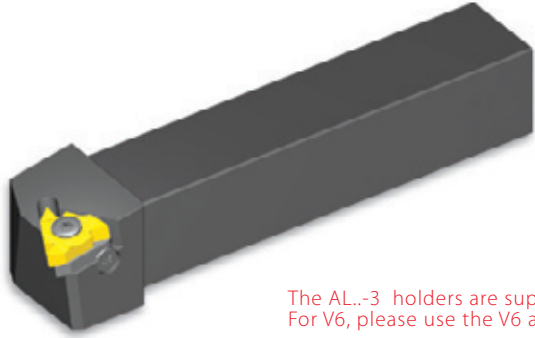

The AL..-3 holders are supplied with standard anvil (see spare parts table below). For V6, please use the V6 anvil YE3-6C. For more info see page 131.

### Off-Set Qualified (FQ)

#### Spare Parts

Insert Size	Ordering Code	Dimensions mm				Spare Parts						
		IC	RH/LH	H=H1=B	F	L1	L2	Insert Screw	Anvil Screw	Torx Key	Anvil RH	Anvil LH
3/8"	AL20-3FQ			20	25	125	25	SA3T	SY3T	K3T	YE3	YI3
	AL25-3FQ			25	32	150	25					
	AL32-3FQ			32	40	170	32					
1/2"	AL25-4FQ			25	32	150	30	SA4T	SY4T	K4T	YE4	YI4
	AL32-4FQ			32	40	170	30					
5/8"	AL32-5FQ			32	40	170	35	SA5T	SY5T	K5T	YE5	YI5

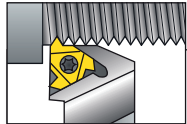

## External Toolholders

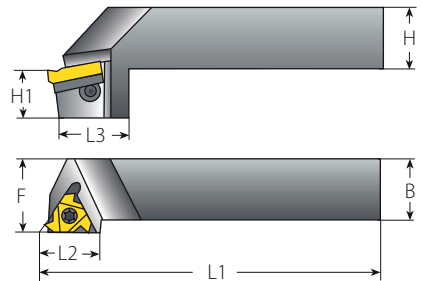
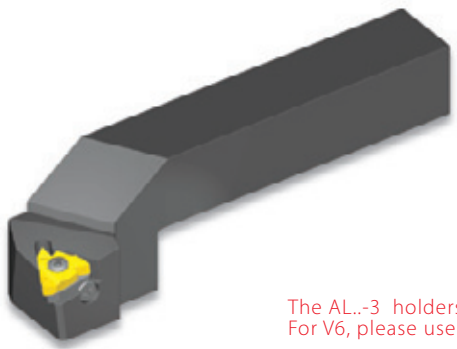

The AL..-3 holders are supplied with standard anvil (see spare parts table below). For V6, please use the V6 anvil YE3-6C. For more info see page 131.

### Drop Head-Qualified (CQ)

#### Spare Parts

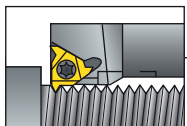

Insert Size	Ordering Code	Dimensions mm							Spare Parts					
		IC	RH/LH	H=B	F	L1	L2	L3	H1	Insert Screw	Anvil Screw	Torx Key	Anvil RH	Anvil LH
3/8"	AL20-3CQ			20	25	125	24	38	17.5	SA3T	SY3T	K3T	YE3	YI3
	AL25-3CQ			25	32	150	24	38	22.2					
	AL32-3CQ			32	40	170	24	38	22.2					
1/2"	AL25-4CQ			25	32	150	30	38	22.2	SA4T	SY4T	K4T	YE4	YI4
	AL32-4CQ			32	40	170	30	38	22.2					
5/8"	AL32-5CQ			32	40	170	33	43	25.4	SA5T	SY5T	K5T	YE5	YI5

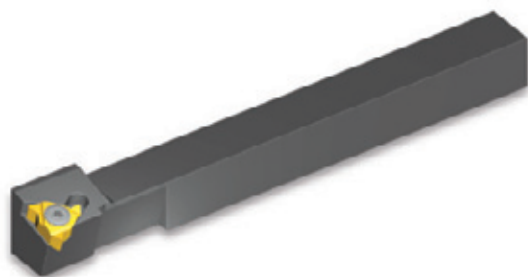

## External + Internal Toolholders



### Miniature Square Shank\*

Miniature Square Shank*						Spare Parts	
Insert Size	Ordering Code	Dimensions mm			Min. Bore dia.		
IC	RH/LH	A	L	F	mm	Insert Screw	Torx Key
1/4"	OV 8-2	8	100	12	14	SN2T	K2T
	OV 10-2	10	100	14	19		

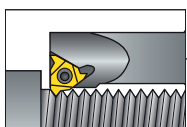

Miniature toolholders have a 0.5° helix angle.



## External + Internal Toolholders



### Miniature Round Shank\*

Miniature Round Shank*									Spare Parts	
Insert Size	Ordering Code	Dimensions mm					Min. Bore dia.			
IC	RH/LH	A	L	L1	D	D1	F	mm	Insert Screw	Torx Key
1/4"	OVR 12-2	11.4	100	25	12	10	7.4	13	SN2T	K2T
	OVR 15-2	14.3	100	32	15	13	8.9	16		
	OVR 16D-2	15.3	100	32	16	13	8.9	16		

Miniature toolholders have a 0.5° helix angle.

\* Miniature square and round toolholders are designed for use on automatic lathes for the optical and other precision industries. They can be used for both external and internal threading, as follows:

<b>Thread</b>	ER	EL	IR	IL
<b>Insert</b>	ER	EL	IR	IL
<b>Holder</b>	LH	RH	RH	LH

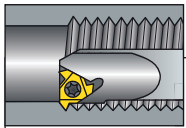



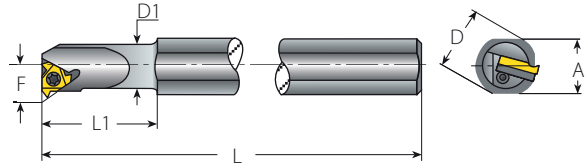
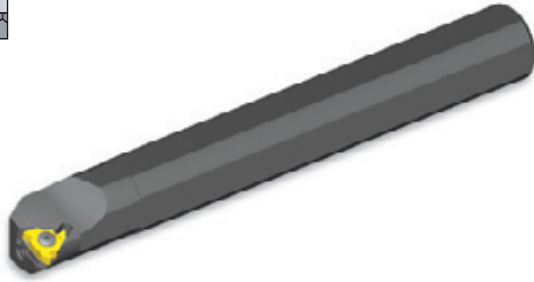

## Internal Toolholders



The AVR..-3 holders are supplied with standard anvil (see spare parts table below).  
For V6, please use the V6 anvil Y13-6C. For more info see page 131.

### Standard

### Spare Parts

Insert Size	Ordering Code	Dimensions mm							Min. Bore dia.					
IC	RH/LH	A	L	L1	D	D1	F	mm				Anvil RH	Anvil LH	
1/4"	NVR10D-2	100			10	10.0	7.3	13				-	-	
	NVR10-2	18.0	180	25	20	10.0	7.3	13	SN2T	-	K2T	-	-	
	NVR13-2	18.0	180	32	20	13.0	8.9	16						
3/8"	NVR13-3	18.0	180	32	20	12.7	10.3	17						
	NVR16-3	18.0	180	40	20	16.0	11.5	20	SN3T	-	K3T	-	-	
	NVR16D-3	15.2	150	32	16	16.0	11.3	20						
	AVR20-3	18.0	180	40	20	20.0	13.4	24						
	AVR25-3	29.0	250	60	32	25.0	16.3	29						
1/2"	AVR25D-3	22.6	200	45	25	24.6	16.1	29	SA3T	SY3T	K3T	Y13	YE3	
	AVR32-3	29.0	250	60	32	32.0	19.6	36						
	AVR40-3	36.0	300	60	40	40.0	23.8	44						
	NVR20-4	18.0	180	50	20	20.0	15.6	27	SN4T	-	K4T	-	-	
	AVR25-4	29.0	250	60	32	25.0	17.4	32						
5/8"	AVR25D-4	22.6	200	45	25	24.6	17.2	32	SA4T	SY4T	K4T	Y14	YE4	
	AVR32-4	29.0	250	60	32	32.0	21.5	39						
	AVR40-4	36.0	300	60	40	40.0	25.8	47						
	AVR50-4	45.0	350	75	50	50.0	30.8	57						
	AVR32-5	29.0	250	60	32	32.0	22.4	40	SN5T	SY5T	K5T	Y15	YE5	
5/8"	AVR40-5	36.0	300	60	40	40.0	26.4	48						
	AVR50-5	45.0	350	75	50	50.0	31.4	58	SA5T	SY5T	K5T	Y15	YE5	
	AVR60-5	54.0	400	75	60	60.0	36.4	69						

The above toolholders have a 1.5° helix angle. For other helix angles, see page 131.  
Toolholders with prefix "N" cannot be used with an anvil.

Holders with coolant channel are available as standard. (Example NVRC 10D-2)

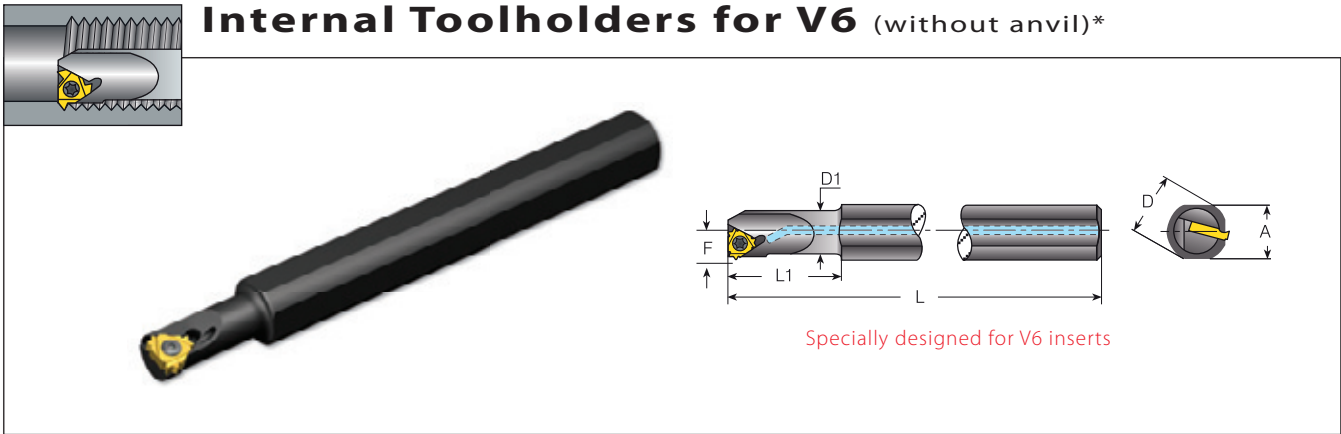

### V6 Style

Spare Parts

Insert Size	Ordering Code	Dimensions mm							Min. Bore dia. mm	Spare Parts		
		IC	RH	A	L	L1	D	D1		F		
3/8" V6	NVRC 13-3 206/001			18	180	32	20	12.7	10.3	17	SN3TM	K3T
	NVRC 16-3 206/002			18	180	40	20	16	11.5	20	SN3T	
	NVRC 16D-3 206/003			15.2	150	40	16	16	11.3	20	SN3T	



The above toolholders have 1.5° helix angle.

\* V6 inserts cannot be used on standard internal toolholders without anvil. For this purpose you must use one of these special V6 toolholders.

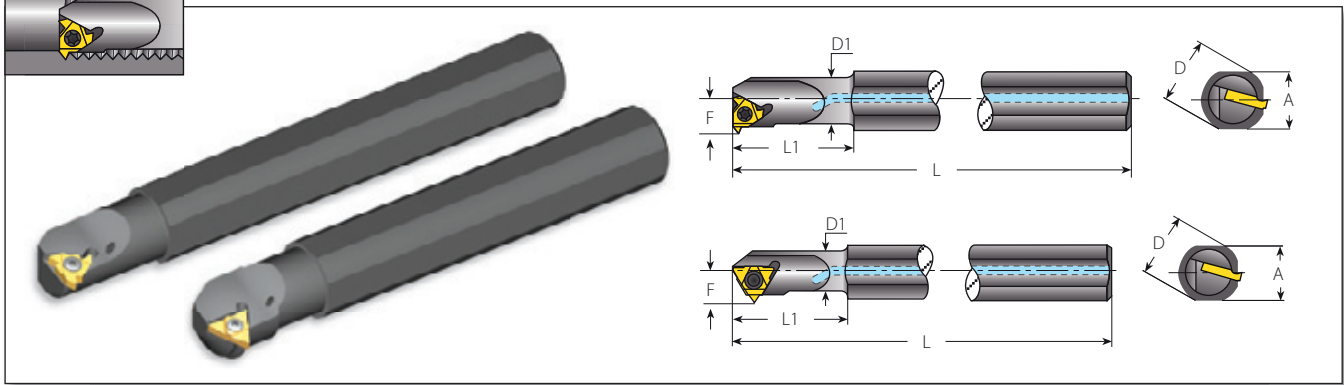

## Internal Toolholders



### Standard for Coarse Pitch

Insert Size	Ordering Code	Dimensions mm				F to insert		Holder Helix	Spare Parts	
		A	L	L1	D	D1	mm	Deg.		
1/4"	NVRC10-2 156/001	18.0	180	25.0	20	10.1	6.53	3.0	SN2T	K2T
	NVRC11-3 156/005	18.0	180	25.4	20	11.2	8.30	4.5	SN3TM	K3T
3/8"	NVRC13-3 156/006	18.0	180	32.0	20	13.0	9.05	4.0	SN3T	K3T
	NVRC13-3 156/016	18.0	180	34.0	20	13.8	8.90	2.5		
1/2"	NVRC17-4 156/007	18.0	180	40.0	20	16.7	11.45	4.0	SN4TM	K4T
	NVRC20-4 156/008	18.0	180	50.0	20	19.6	12.55	3.5	SN4T	K4T
	NVRC20-4 156/009	18.0	180	50.0	20	19.6	12.55	3.0		
5/8"	NVRC25-5 156/012	29.0	250	60.0	32	25.0	16.78	3.3	SN5TM	K5T
	NVRC28-5 156/010	29.0	250	50.0	32	28.0	17.80	3.5		

### U Style for Coarse Pitch

Insert Size	Ordering Code	Dimensions mm				F to insert		Holder Helix	Spare Parts	
		A	L	L1	D	D1	mm	Deg.		
6.0U	NVRC8-6.0U 156/003	18.0	180	24.0	20	8.0	5.86	4.0	SN6MT	K6MT
1/4"U	NVRC10-2U 156/004	18.0	180	32.0	20	10.0	7.40	4.0	SM2T8	K2T
	NVRC11-2U 156/002	18.0	180	32.0	20	11.2	7.30	3.0		
3/8"U	NVRC11-3U 156/020	18.0	180	32.0	20	11.0	8.23	4.5	SN3TM	K3T
	NVRC14-3U 156/018	18.0	180	38.0	20	13.4	9.99	4.5		
	NVRC15-3U 156/019	18.0	180	38.0	20	15.4	10.99	4.0		
1/2"U	NVRC20-4U 156/011	18.0	180	40.0	20	19.2	13.68	4.0	SN4T	K4T
	NVRC25-4U 156/013	29.0	250	60.0	32	25.0	17.63	3.5		
	NVRC32-4U 156/014	29.0	250	60.0	32	29.7	18.76	3.3		
5/8"U	NVRC32-5U 156/015	29.0	250	60.0	32	31.6	20.96	3.2	SA5T	K5T



## Internal Toolholders

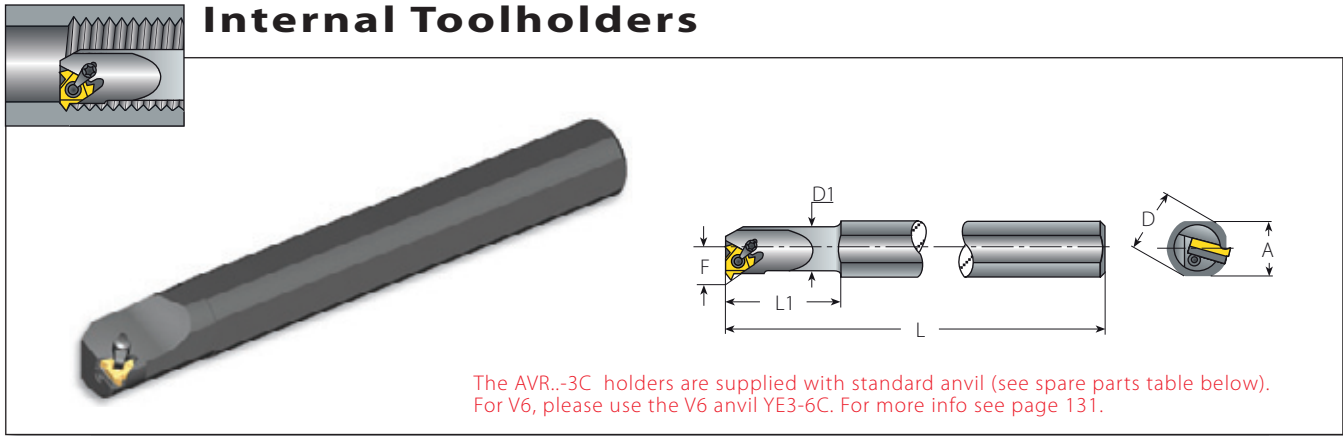

The AVR.-3C holders are supplied with standard anvil (see spare parts table below). For V6, please use the V6 anvil YE3-6C. For more info see page 131.

### Standard with Clamp

(Dual System, Screw or Clamp)

#### Spare Parts

Insert Size	Ordering Code	Dimensions mm						Min. bore dia.						
IC	RH/LH	A	L	L1	D	D1	F	mm	Insert Screw	Anvil Screw	Clamp	Torx Key	Anvil RH	Anvil LH
3/8"	AVR20-3C	18.0	180	50	20	20.0	13.4	24	SA3T	SY3T	C3	K3CT	YI3	YE3
	AVR25-3C	28.0	250	60	32	25.0	16.3	29						
	AVR25D-3C	22.6	200	45	25	24.6	16.1	29						
	AVR32-3C	29.0	250	60	32	32.0	19.6	36						
1/2"	AVR40-3C	36.0	300	60	40	40.0	23.8	44	SA4T	SY4T	C4	K4T	YI4	YE4
	AVR25-4C	29.0	250	60	32	25.0	17.4	32						
	AVR25D-4C	22.6	200	45	25	24.6	17.2	32						
	AVR32-4C	29.0	250	60	32	32.0	21.5	39						
5/8"	AVR40-4C	36.0	300	60	40	40.0	25.8	47	SN5T	SY5T	C5	K5T	YI5	YE5
	AVR32-5C	29.0	250	60	32	32.0	22.4	40						
	AVR40-5C	36.0	300	60	40	40.0	26.4	48						
	AVR50-5C	45.0	350	75	50	50.0	31.4	58						
	AVR60-5C	54.0	400	75	60	60.0	36.4	69	SA5T	SY5T	C5	K5T	YI5	YE5

## Internal Toolholders

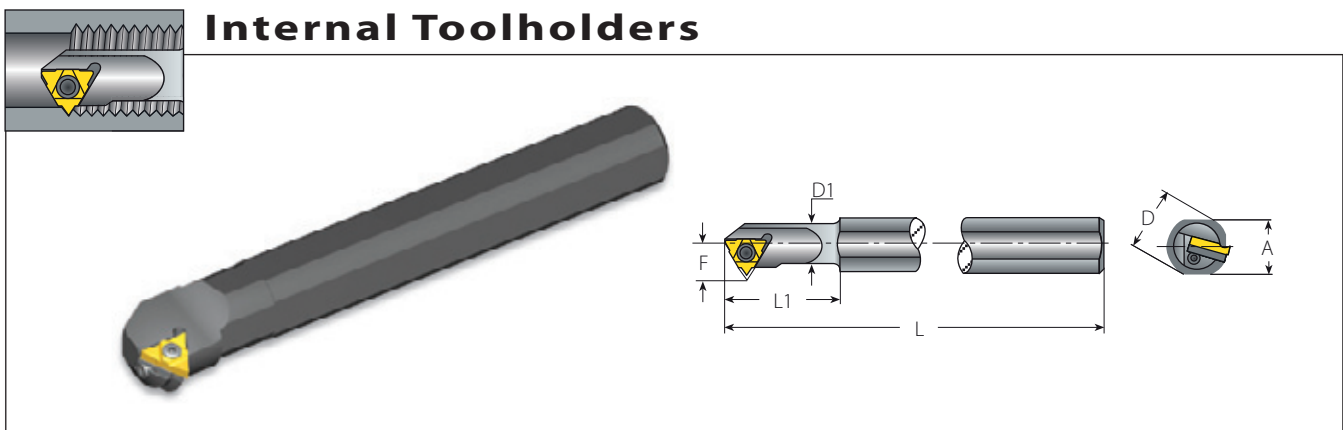

### U Style

#### Spare Parts

Insert Size	Ordering Code	Dimensions mm						Min. bore dia.					
IC	RH/LH	A	L	L1	D	D1	F	mm	Insert Screw	Anvil Screw	Torx Key	Anvil RH	Anvil LH
1/2"U	AVR32-4U	29	250	60	32	32	25.5	42	SA4T	SY4T	K4T	YI4U	YE4U
	AVR40-4U	36	300	60	40	40	29.5	51					
5/8"U	NVR32-5U	29	250	60	32	32	24.7	42	SN5T	-	K5T	-	-
	AVR40-5U	36	300	60	40	40	29.4	53	SA5T	SY5T	K5T	YI5U	YE5U
	AVR50-5U	45	350	75	50	50	34.3	63					
	AVR60-5U	54	400	75	60	60	39.3	74					

## Internal Toolholders

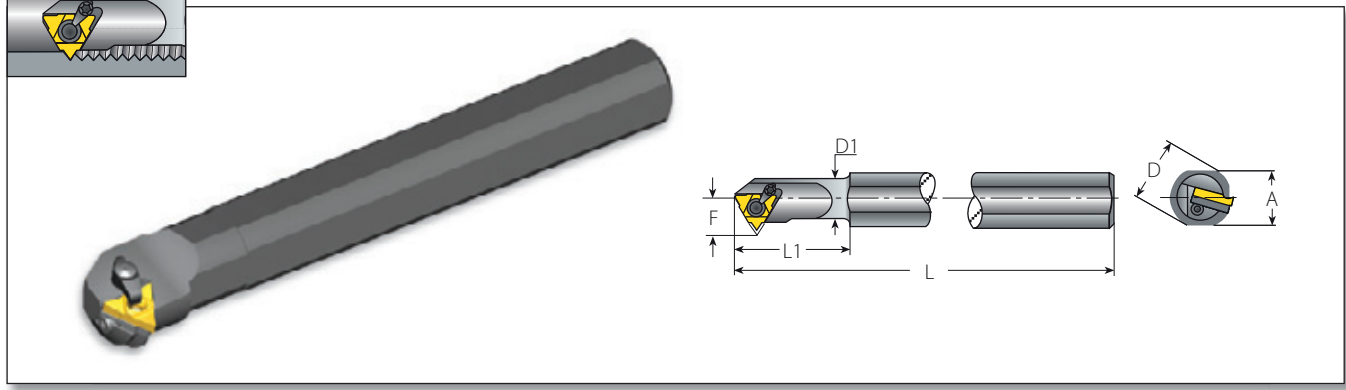

### U style with Clamp (Dual System, Screw or Clamp)

Insert Size	Ordering Code	Dimensions mm							Min. bore dia.	Spare Parts					
		IC	RH/LH	A	L	L1	D	D1		F	mm	Insert Screw	Anvil Screw	Clamp	Torx Key
1/2"U	AVR32-4UC	29.0	250	60	32	32.0	25.5	42	SA4T	SY4T	C4	K4T	YI4U	YE4U	
	AVR40-4UC	36.0	300	60	40	40.0	29.5	51							
	AVR40-5UC	36.0	300	60	40	40.0	29.4	53							
5/8"U	AVR50-5UC	45.0	350	75	50	50.0	34.4	63	SA5T	SY5T	C5	K5T	YI5U	YE5U	
	AVR60-5UC	54.0	400	75	60	60.0	39.3	74							

The above toolholders have a 1.5° helix angle. For other helix angles, see page 131.

## Internal Toolholders

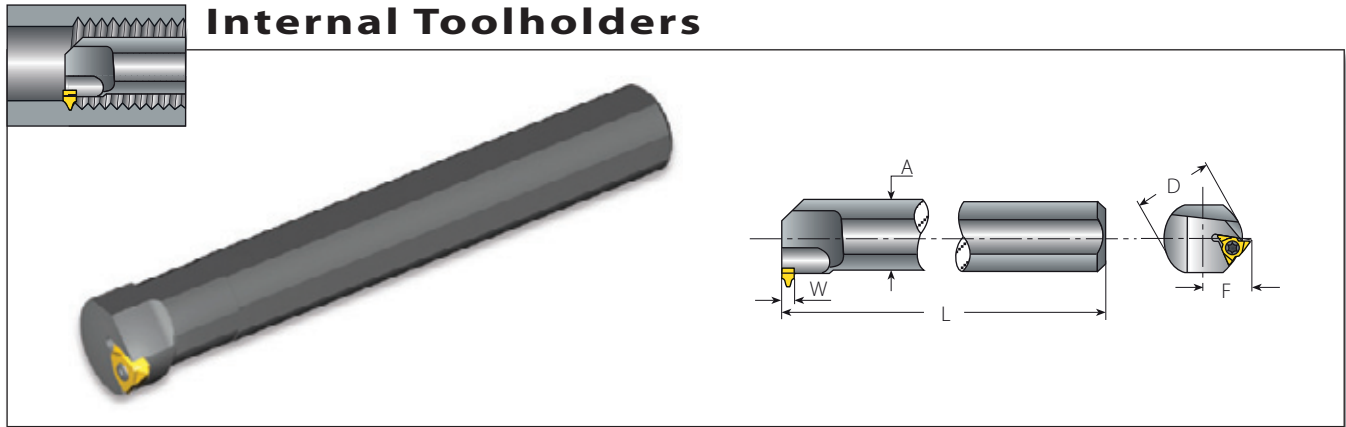

### V Style

Insert Size	Ordering Code	Dimensions mm					Spare Parts	
		IC	RH/LH	A	L	D	F	W
5/8"V	NVR40-5V	36	300	40	28.4	6.5	SN6T	K6T
	NVR50-5V	45	350	50	33.4	6.5		
	NVR60-5V	54	400	60	38.0	6.5		

The above toolholders have a 1.0° helix angle.

### Minimum Bore Dia

	Pitch mm	6.0 ISO	8.0 ISO	10.0 ISO	2.5 W
	Pitch tpi	4 UN	3 UN		
NVR40-5V		48	54	62	68
NVR50-5V		58	58	62	68
NVR60-5V		68	68	68	68

## Internal Toolholders

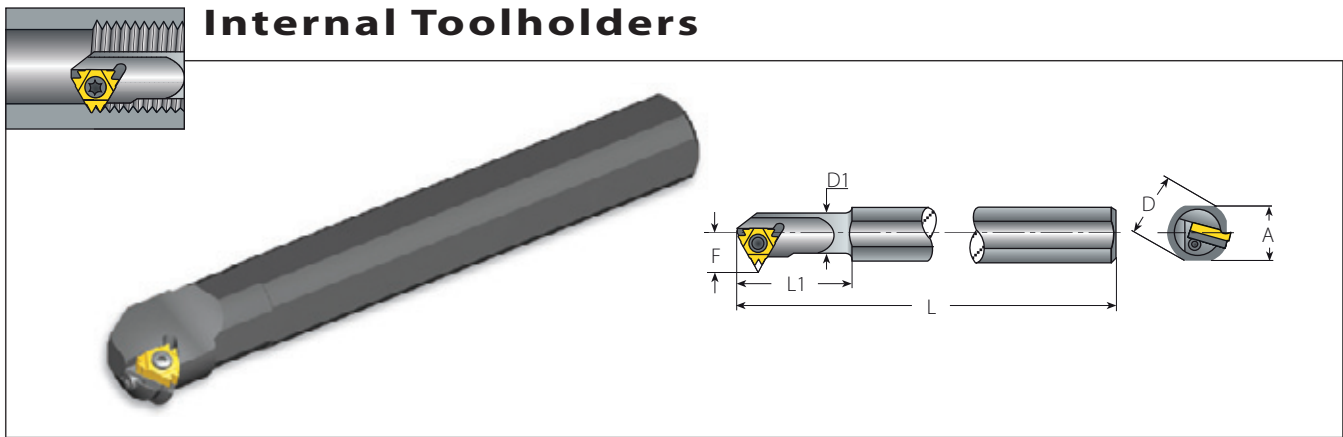

### Z+ Style

Insert Size	Ordering Code	Dimensions mm							Min. bore dia	Spare Parts				
		A	L	L1	D	D1	F	mm		Insert Screw	Anvil Screw	Torx Key	Anvil RH	Anvil LH
1/2"Z	AVR32-4Z	29	250	60	32	32	25.5	42	SA4T	SY4T	K4T	YI4Z	YE4Z	
	AVR40-4Z	36	300	60	40	40	29.5	51						
5/8"Z	NVR32-5Z	29	250	60	32	32	24.7	42	SN5T	-	K5T	-	-	
	AVR40-5Z	36	300	60	40	40	29.4	53						
	AVR50-5Z	45	350	75	50	50	34.3	63	SA5T	SY5T	K5T	YI5Z	YE5Z	
	AVR60-5Z	54	400	75	60	60	39.3	74						

All Z style toolholders have a 1.5° helix angle.

## Internal Toolholders

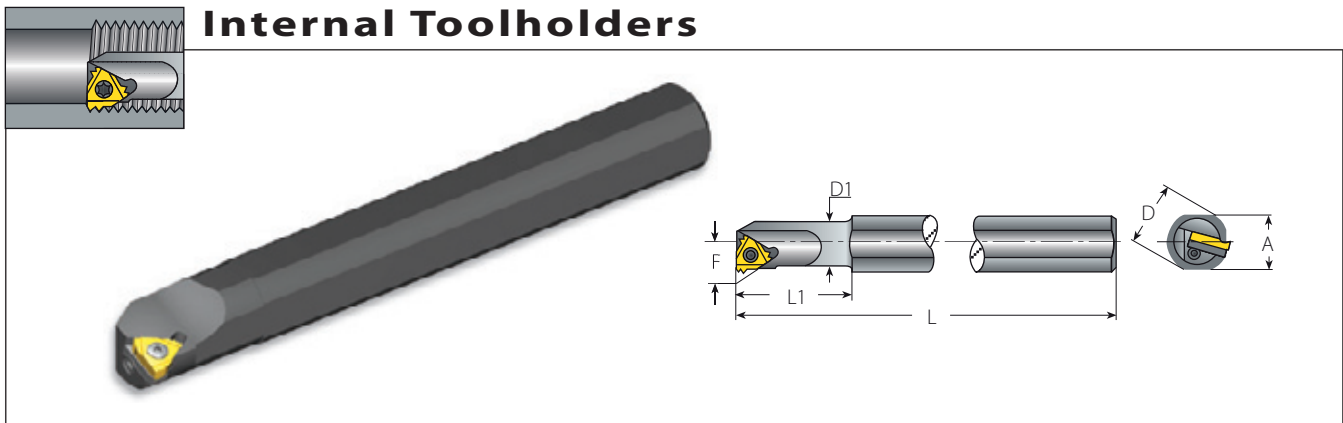

### M+ Style

Insert Size	Ordering Code	Dimensions mm							Min. bore dia	Spare Parts				
		A	L	L1	D	D1	F	mm		Insert Screw	Anvil Screw	Torx Key	Anvil RH	Anvil LH
5/8"M	AVR32-5M	29	250	60	32	32	22.4	40	SN5T	SY5T	K5T	YI5M	YE5M	
	AVR40-5M	36	300	60	40	40	26.4	48						
	AVR50-5M	45	350	75	50	50	31.4	58	SA5T	SY5T	K5T	YI5M	YE5M	
	AVR60-5M	54	400	75	60	60	36.4	69						

All M style toolholders have a 1.5° helix angle.

## Internal Toolholders

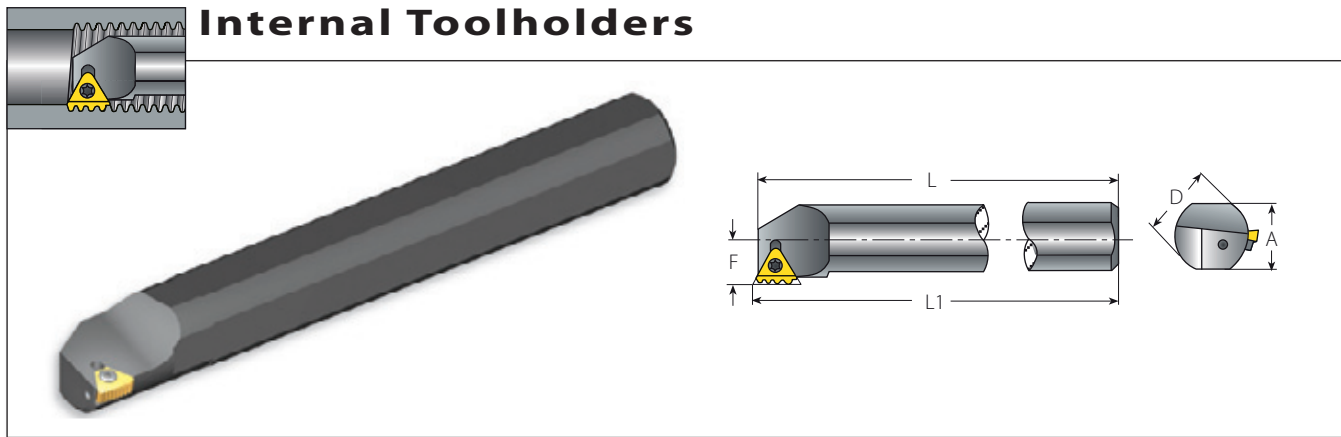

### T+ Style

### Spare Parts



Insert Size	Ordering Code	Dimensions mm					Min. bore dia	Spare Parts				
		A	L	L1	D	F		Insert Screw	Anvil Screw	Torx Key	Anvil Torx Key	Anvil RH/LH
1/2" T	AVR40-4T	36	300	302	40	23.3	60					
	AVR50-4T	45	350	352	50	28.3	70	SA4T	SY4K2	K4T	K2	Y4T
	AVR60-4T	54	400	402	60	33.3	80					

All toolholders have a 0° helix angle.  
 Holders with coolant channel available as standard. (Example: AVRC-4T)

## Internal Toolholders

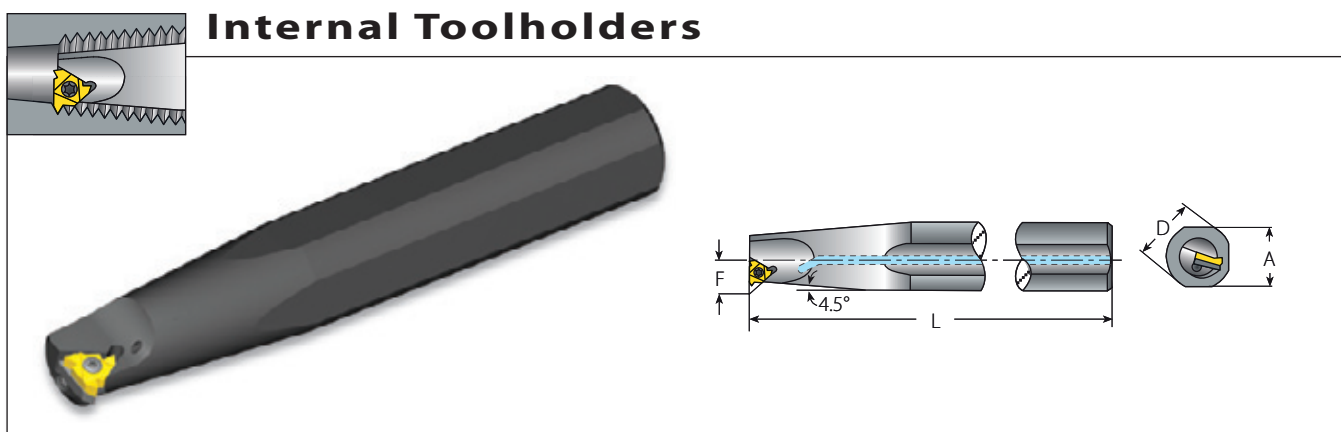

### API

### Spare Parts

Insert Size	Ordering Code	Thread Form	Connection no. or size	Dimensions mm				Spare Parts				
				A	L	D	F	Insert Screw	Anvil Screw	Torx Key	Anvil RH	Anvil LH
5/8"	AVR50-5OIL	V0.038R	NC23-NC38	45	300	50	22.6					
	AVRC50-5OIL	V0.038R	NC23-NC38					SA5T	SY5T	K5T	Y15OIL	YE5OIL
	AVR80-5OIL	V0.050R	NC40-NC77	72	400	80	39.7					
	AVRC80-5OIL	V0.050R	NC40-NC77									

The above toolholders have a 1.5° helix angle.  
 Toolholders ordered with an internal coolant channel have an internal BSP 1/2" thread for connection to the flexible coolant pipe.  
 The above toolholders are for RH inserts. For LH inserts, add LH to the toolholder's ordering code. (Example AVR50-5OIL LH)

# Internal Toolholders

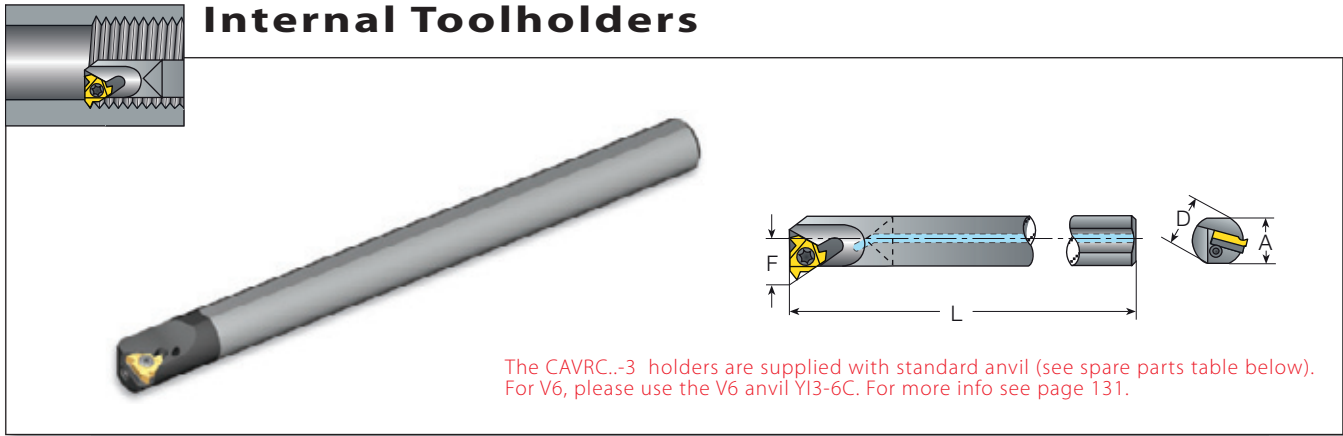

The CAVRC...-3 holders are supplied with standard anvil (see spare parts table below). For V6, please use the V6 anvil YI3-6C. For more info see page 131.

## Standard with Carbide Shank

Standard with Carbide Shank							Spare Parts				
Insert Size	Ordering Code	Min. bore dia									
IC	RH/LH	D	A	F	L	mm	Insert Screw	Anvil Screw	Torx Key	Anvil RH	Anvil LH
1/4"	CNVRC10-2	10	9.5	7.3	150	13	SN2T	-	K2T	-	-
	CNVRC12-2	12	11.7	8.3	180	15					
3/8"	CNVRC16-3	16	15.6	11.5	200	20	SN3T	-	K3T	-	-
	CAVRC20-3	20	19.5	13.4	250	24	SA3T	SY3T	K3T	YI3	YE3
1/2"	CNVRC20-4	20	19.5	13.8	250	25	SN4T	-	K4T	-	-

The above toolholders have 1.5° helix angle. For other helix angles see page 131.

Toolholders with prefix "CN" cannot be used with an anvil. The above Toolholders have coolant channel as standard.

Carbide Shank toolholders should be used when extra accuracy is required or when the bar length to bar diameter ratio exceeds 3:1.

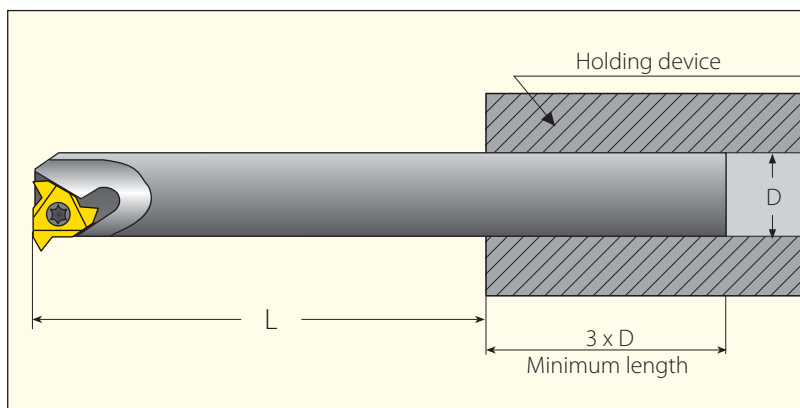

The overhang to bar diameter ratio should be as small as possible to eliminate the chance of chatter (vibration). The minimum length inside a holding device should be 3 times the diameter of the bar shank.

# Thread Turning Kits\*

Thread Turning  
KITS



## TT External + Internal Kit

Ordering Code		Content		
KHTT3EI- ...	Holder External+Internal	10 x External Inserts	10 x Internal Inserts	Torx Key 
	AL 20-3 AVRC 20-3	3ERA60...	3IRA60...	K3T
		3ERG60...	3IRG60...	
		3ER11W...	3IR11W...	
		3ER14W...	3IR14W...	
		3ER1.0ISO...	3IR1.0ISO...	
		3ER1.25ISO...	3IR1.25ISO...	
		3ER1.5ISO...	3IR1.5ISO...	
		3ER2.0ISO...	3IR2.0ISO...	
		3ER2.5ISO...	3IR2.5ISO...	
3ER3.0ISO...	3IR3.0ISO...			

## TT External Kit

Ordering Code		Content	
KHTT3E- ...	Holder External	10 x External Inserts	Torx Key 
	AL 20-3	3ERA60...	K3T
		3ERG60...	
		3ER11W...	
		3ER14W...	
		3ER1.0ISO...	
		3ER1.25ISO...	
		3ER1.5ISO...	
		3ER2.0ISO...	
		3ER2.5ISO...	
3ER3.0ISO...			

## TT Internal Kit

Ordering Code		Content	
KHTT3I- ...	Holder Internal	10 x Internal Inserts	Torx Key 
	AVRC 20-3	3IRA60...	K3T
		3IRG60...	
		3IR11W...	
		3IR14W...	
		3IR1.0ISO...	
		3IR1.25ISO...	
		3IR1.5ISO...	
		3IR2.0ISO...	
		3IR2.5ISO...	
3IR3.0ISO...			



Ordering Code Example: KHTT3I-VKX  
\* Additional kits are available by request.

## Thread Turning Inserts Kits\*





TT Inserts Kit

### TT External Insert Kit



Ordering Code	Content		Torx Key 	Insert Screw 
KITT3E- ...	10 x External Inserts		K3T	SA3T
	3ERA60...			
	3ERG60...			
	3ER11W...			
	3ER14W...			
	3ER1.0ISO...			
	3ER1.25ISO...			
	3ER1.5ISO...			
	3ER2.0ISO...			
	3ER2.5ISO...			
3ER3.0ISO...				

### TT Internal Insert Kit

Ordering Code	Content		Torx Key 	Insert Screw 
KITT3I- ...	10 x External Inserts		K3T	SA3T
	3IRA60...			
	3IRG60...			
	3IR11W...			
	3IR14W...			
	3IR1.0ISO...			
	3IR1.25ISO...			
	3IR1.5ISO...			
	3IR2.0ISO...			
	3IR2.5ISO...			
3IR3.0ISO...				

### TT External+Internal V6 Insert Kit



Ordering Code	Content		Torx Key 	Insert Screw 
KITT3V6EI- ...	5 x Internal Inserts	5 x External Inserts	K3T	SA3T
	3IRS60-6C...	3ERS60-6C...		
	3IR1.0ISO-6C...	3ER1.0ISO-6C...		
	3IR1.25ISO-6C...	3ER1.25ISO-6C...		
	3IR1.5ISO-6C...	3ER1.5ISO-6C...		
	3IR2.0ISO-6C...	3ER2.0ISO-6C...		

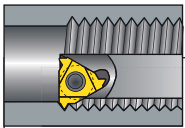

## Internal Toolholders

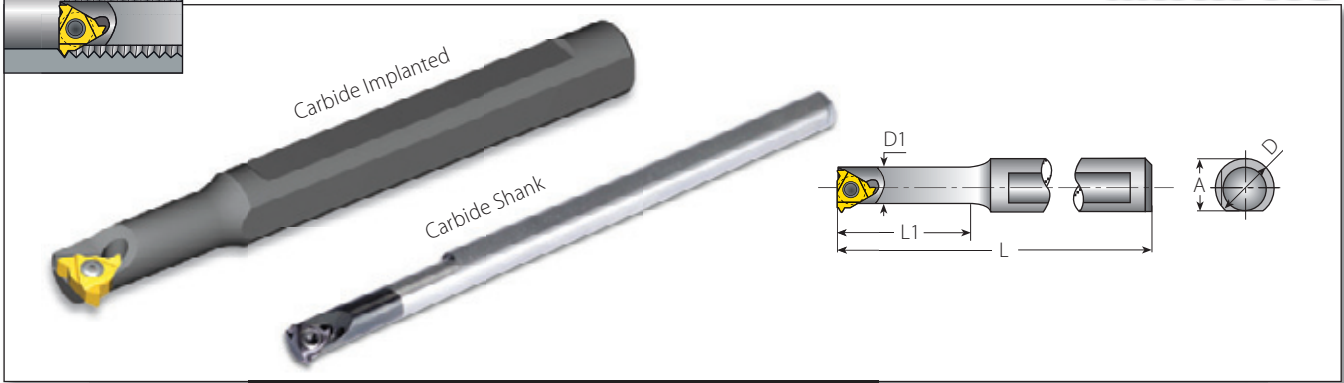

### Mini-3

Insert Size	Ordering Code	Dimensions mm					Anti-Vibration System	Spare Parts	
		A	L	L1	D	D1			
4.0	CNVR 5-4.0K	5.2	100	26	6	5.1	Carbide Shank	SN4MT	K6MT
	SNVR 5-4.0K	11.0	100	12	12	5.1	No		
6.0	SNVR 12U-6.0	11.4	82	16	12	8	No	SN6MT	K6MT
	BNVR 10S-6.0	9.4	89	22	10	8	Carbide Implanted		
	BNVR 10M-6.0	9.4	98	31	10	8	Carbide Implanted		
	BNVR 10L-6.0	9.4	110	43	10	8	Carbide Implanted		

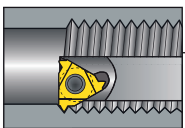

## Internal Toolholders

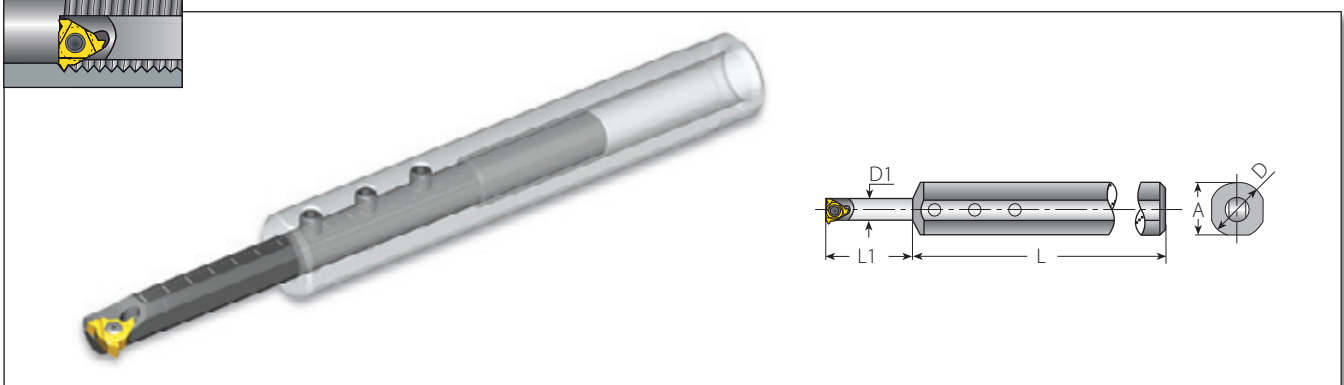

### Mini-3 Adjustable

Insert Size	Ordering Code		Dimensions mm					Spare Parts			
	Sleeve	Holder LH/RH	A	L	L1	D	D1				
6.0	SV16-8.0	BNVR8.0T-6.0	15.6	100	8-56	16	8	SN6MT	K6MT	S4.0	K2.0



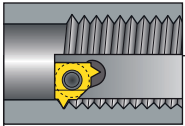

## Internal Toolholders

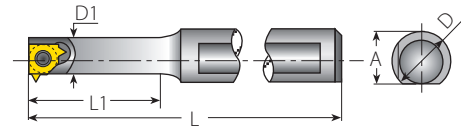

Thread Turning Toolholders

### Mini-L

Insert Size		Ordering Code	Dimensions mm				Anti-Vibration System	Spare Parts	
IC	RH/LH	A	L	L1	D	D1		Insert Screw	Torx Key
5.0L	SNVR 10U-5L	9.4	81	16	10	6.2	No	SN5LT	K5LT
	BNVR 10S-5L	9.4	87	22	10	6.2	Carbide Implanted		
	BNVR 10M-5L	9.4	97	31	10	6.2	Carbide Implanted		
	BNVR 10L-5L	9.4	109	43	10	6.2	Carbide Implanted		

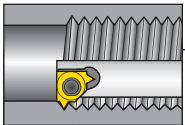

## Internal Toolholders

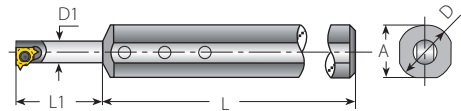
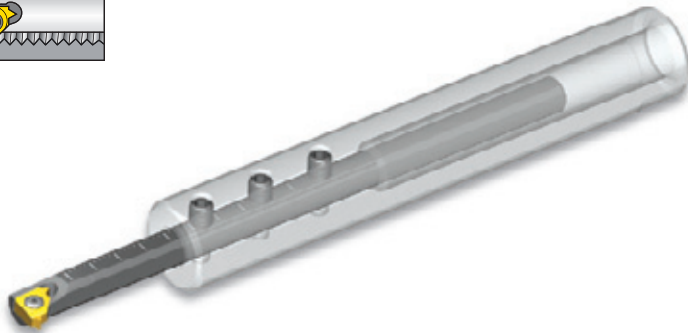

### Mini-L-Adjustable

Insert Size		Ordering Code	Dimensions mm					Spare Parts			
IC	Sleeve	Holder LH/RH	A	L	L1	D	D1	Insert Screw	Torx Key for Insert Screw	Holder Screw x3	Key for Holder Screw
5.0L	SV16-6.2	BNVR6.2T-5L	15.6	100	8-44	16	6.2	SN5LT	K5LT	S4.0	K2.0

# Internal Toolholders



Thread Turning Toolholders

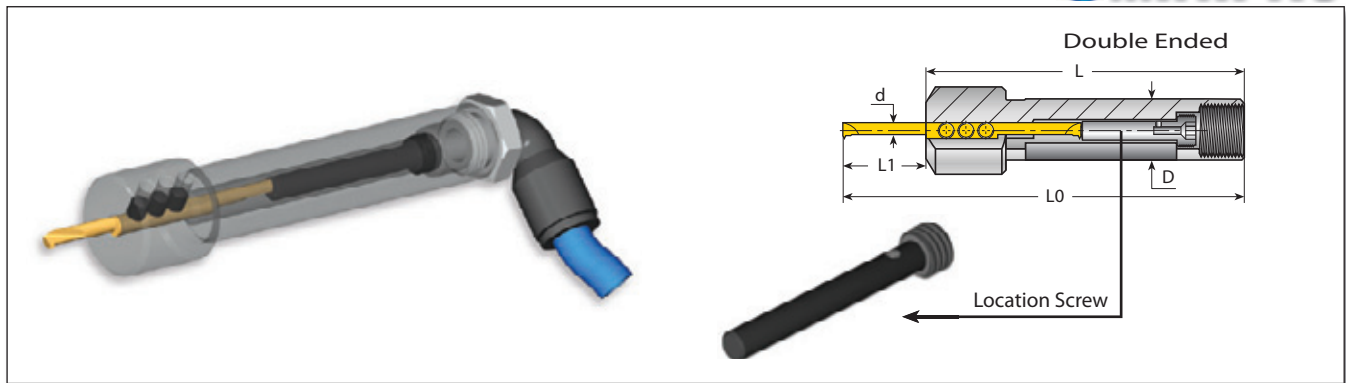

### Spare Parts



### Micro - Double Ended

Micro Insert Dia.	Shank Dia.	Ordering Code	Dimensions mm			Location Screw*			Clamping Screw x 3	
			d [mm]	D	L	L1	L0	Screw	M	Key
3	10	SMC10-3.0	80	9- Short	89	4GISM8X28	28	K4.0	M4X0.7X4.0	K2.0
	12	SMC12-3.0		16- Medium	96	4GISM8X21	21			
	16	SMC16-3.0	95	9- Short	104	4GISM8X49	49			
	20	SMC20-3.0		16- Medium	111	4GISM8X42	42			
4	10	SMC10-4.0	80	9- Short	89	4GISM8X28	28			
	12	SMC12-4.0		16- Medium	96	4GISM8X21	21			
				21- Long	101	4GISM8X16	16			
	16	SMC16-4.0	95	9- Short	104	4GISM8X49	49			
	20	SMC20-4.0		16- Medium	111	4GISM8X42	42			
			21- Long	116	4GISM8X37	37				
6	12	SMC12-6.0	80	9- Short	89	4GISM8X28	28			
				16- Medium	96	4GISM8X21	21			
				21- Long	101	4GISM8X16	16			
	16	SMC16-6.0	95	9- Short	104	4GISM8X49	49			
				16- Medium	111	4GISM8X42	42			
				21- Long	116	4GISM8X37	37			

\* Every toolholder package contains the full range of location screws needed.

# Internal Toolholders



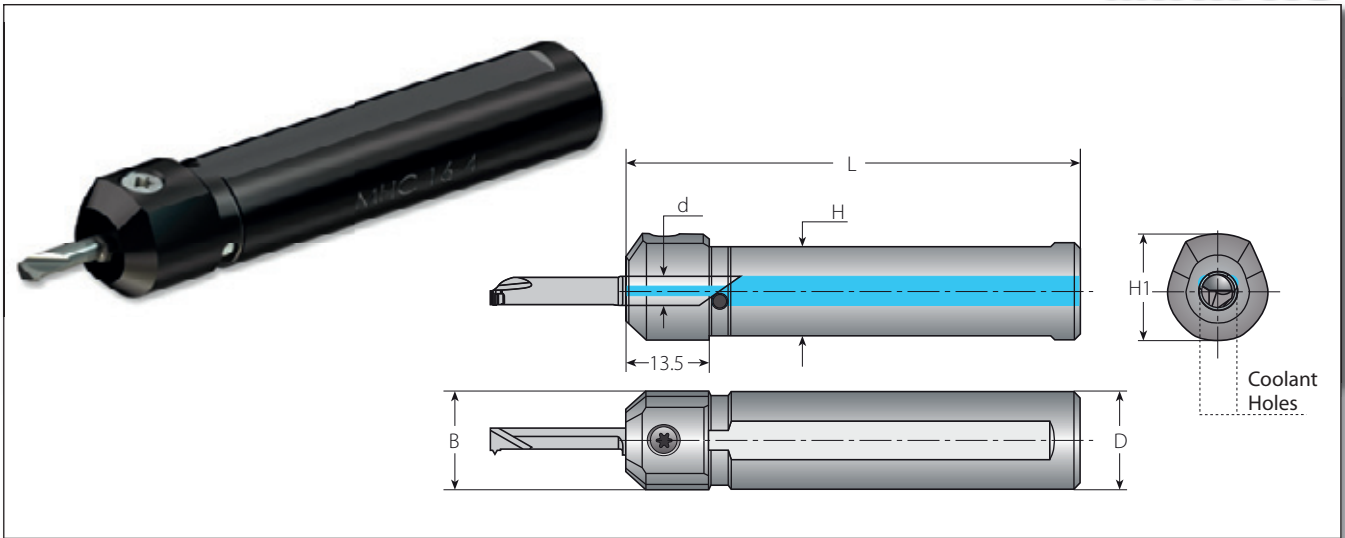

Thread Turning Toolholders



## Micro - Single Ended

Spare Parts **microscope**

Micro Insert Dia.	Ordering Code	Dimensions (mm)					
d [mm]		D=B	H1	H	L	Clamping Screw	Key
4.0	MHC 10-4	10	14	8.8	65	SL7DT15	KT15
	MHC 12-4	12	16	10.8	70		
	MHC 16-4	16	17.6	14.8	75		
	MHC 20-4	20	22	18.8	84		
5.0	MHC 10-5	10	14	8.8	65		
	MHC 12-5	12	16	10.8	70		
	MHC 16-5	16	18.6	14.8	75		
	MHC 20-5	20	22	18.8	84		
6.0	MHC 12-6	12	16	10.8	70		
	MHC 16-6	16	18.6	14.8	75		
	MHC 20-6	20	22	18.8	84		
7.0	MHC 16-7	16	18.6	14.8	75		
	MHC 20-7	20	22	18.8	84		

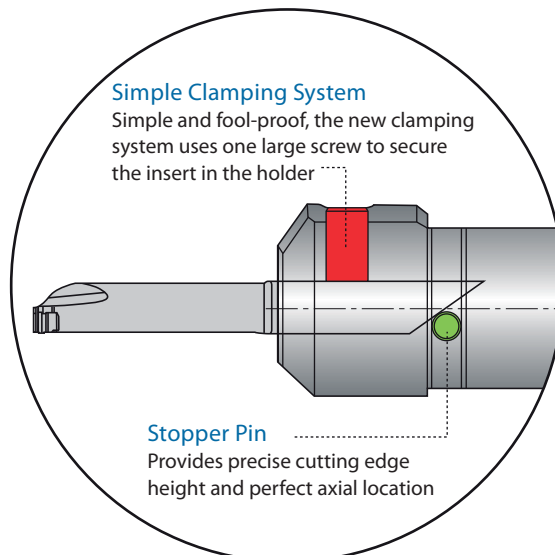

## microscope Kits\*



### microscope Kit 4

Ordering Code	Content			
	Holder	Inserts	Torx Key 	
KMS4-...	MHC16-4	M429TH F55 L16R...	Threading	KT15
		M429TH F60 L16R...		
		M432BC R15 L16R...	Boring	
		M422BC R10 L09R...		
		M442CL R15 L16R...	Copy Long Nose	
		M442GS W100 L15R...	Grooving Square	

### microscope Kit 5

Ordering Code	Content			
	Holder	Inserts	Torx Key 	
KMS5-...	MHC16-5	M542TH 0.75ISO L16R...	Threading	KT15
		M549TH 1.00ISO L16R...		
		M552BC R20 L16R...	Boring	
		M552BC R20 L26R...		
		M552CL R20 L25R...	Copy Long Nose	
		M552GS W100 L15R...	Grooving Square	

### microscope Kit 6

Ordering Code	Content			
	Holder	Inserts	Torx Key 	
KMS6-...	MHC16-6	M659TH A60 L16R...	Threading	KT15
		M659TH A55 L16R...		
		M662BC R20 L21R...	Boring	
		M662BC R20 L30R...		
		M662CL R20 L30R...	Copy Long Nose	
		M662GS W100 L15R...	Grooving Square	

## Spare Parts

### External and Internal Toolholders (not including Micro and Microscope)



Toolholder	IC	Designation	Thread	Designation	Thread	Key	EX RH / IN LH	IN RH / EX LH
Standard	1/4"	SN2T	M2.6x0.45x6.5	-	-	K2T	-	-
	3/8", 3/8"V6*	SA3T	UNC5x12.0	SY3T	UNC5x7.3	K3T	YE3/YE3-6C	Y13/Y13-6C
	1/2"***	SA4T	UNC8x15.2	SY4T	UNC8x9.3	K4T	YE4	Y14
	5/8"	SA5T	M5x0.8x22.0	SY5T	M5x0.8x9.5	K5T	YE5	Y15
Standard with clamp	3/8"	SA3T/C3	UNC5x12.0/M5x0.8x22.0	SY3T	UNC5x7.3	K3CT	YE3	Y13
	1/2"	SA4T/C4	UNC8x15.2/M6x1.0x29.5	SY4T	UNC8x9.3	K4T	YE4	Y14
	5/8"	SA5T/C5	M5x0.8x22.0/M8x1.25x28.0	SY5T	M5x0.8x9.5	K5T	YE5	Y15
U Style	1/2"U	SA4T	UNC8x15.2	SY4T	UNC8x9.3	K4T	YE4U	Y14U
	5/8"U	SA5T	M5x0.8x22.0	SY5T	M5x0.8x9.5	K5T	YE5U	Y15U
U Style with clamp	1/2"	SA4T/C4	UNC8x15.2/M6x1.0x29.5	SY4T	UNC8x9.3	K4T	YE4U	Y14U
	5/8"	SA5T/C5	M5x0.8x22.0/M8x1.25x28.0	SY5T	M5x0.8x9.5	K5T	YE5U	Y15U
V Style	1/4"V	SN2T	M2.6x0.45x6.5	-	-	K2T	-	-
	3/8"V	SN3TV	UNC5x7.5	-	-	K3T	-	-
	1/2"V	SN4T	UNC8x15.2	-	-	K4T	-	-
	5/8"V	SN6T	M6x1.0x29.5	-	-	K6T	-	-
Z+ Style	1/2"Z	SA4T	UNC8x15.2	SY4T	UNC8x9.3	K4T	YE4Z	Y14Z
	5/8"Z	SA5T	M5x0.8x22.0	SY5T	M5x0.8x9.5	K5T	YE5Z	Y15Z
M+ Style	3/8"M	SA3T	UNC5x12.0	SY3T	UNC5x7.3	K3T	YE3M	Y13M
	1/2"M	SA4T	UNC8x15.2	SY4T	UNC8x9.3	K4T	YE4M	Y14M
	5/8"M	SA5T	M5x0.8x22.0	SY5T	M5x0.8x9.5	K5T	YE5M	Y15M
T+ Style	1/2"T	SA4T	UNC8x15.2	SY4K2	UNC8x7.3	K4T/K2	Y4T	Y4T
API	5/8"	SA5T/C5	M5x0.8x22.0/M8x1.25x28.0	SY5T	M5x0.8x9.5	K5T	YE5OIL	Y15OIL
Mini-L	5.0L	SN5LT	M2x0.4x4.1	-	-	K5LT	-	-
Mini-3	4.0mm	SN4MT	M2x0.4x4.0	-	-	K6MT	-	-
	6.0mm	SN6MT	M1.8x0.35x4.5	-	-	K6MT	-	-
Mini Adjustable Holder	-	S4.0	M4x0.7x4.0	-	-	K2.0	-	-

\* NVR16-3 requires insert screw SN3T (UNC5x9.5) \*\* NVR20-4 requires insert screw SN4T (UNC8x12.0) SN5T (M5x0.8x18) for holders A/NVR32-5...

For Micro and Microscope Toolholders see pages 120-121.





# Thread Turning

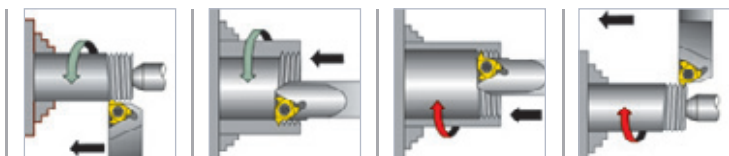

[> Technical Data](#)

# THREAD TURNING TECHNICAL DATA

■ Thread Terminology .....	Page 127
■ Machining a Multi-Start Thread .....	Page 128
■ Insert Profile Styles .....	Page 128
■ Thread Turning Methods .....	Page 129
■ Thread Infeed Methods .....	Page 129
■ Calculating the Helix Angle and Choosing the Right Anvil .....	Page 130
■ Anvils and Anvil Kits .....	Page 131
■ Grades and Their Applications .....	Page 132
■ Recommended Grades and Cutting Speeds - (not including Mini and Micro) .....	Page 133
■ Recommended Grades and Cutting Speeds - (Mini and Micro) .....	Page 134
■ Number of Passes .....	Page 135
■ Cutting Conditions Depends On... ..	Page 135
■ Number of Passes and Depth of Cut per Pass for Multi+ Inserts .....	Page 136
■ Step by Step Thread Turning - Examples .....	Page 138
■ Material Comparison Table .....	Page 142
■ Troubleshooting .....	Page 146



# Thread Terminology

## External Thread

A thread on the external surface of a cylinder screw or cone

## Depth of Thread

The distance between crest and root measured normal to the axis.

## Pitch

The distance between corresponding points on adjacent thread forms measured parallel to the axis. This distance can be defined in millimeters or by the tpi (threads per inch), which is the reciprocal of the pitch.

## Nominal Diameter

The diameter from which the diameter limits are derived by the application of deviation allowances and tolerances.

## External Thread

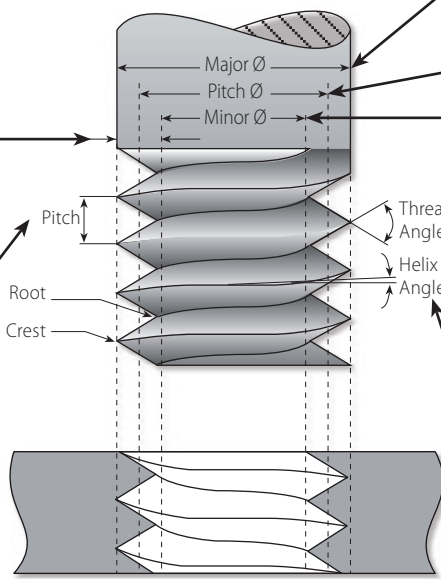

## Internal Thread

A thread on the internal surface of a cylinder or cone.

## Major Diameter

The largest diameter of a screw thread.

## Pitch Diameter

On a straight thread, the diameter of an imaginary cylinder, the surface of which cuts the thread forms where the width of the thread and groove are equal.

## Minor Diameter

The smallest diameter of a screw thread.

## Helix Angle

For a straight thread, where the lead of the thread and the pitch diameter circle circumference form a right angled triangle, the helix angle is the angle opposite the lead.

## Straight Thread

A thread formed on a cylinder

## Taper Thread

A thread formed on a cone

## Left-hand thread

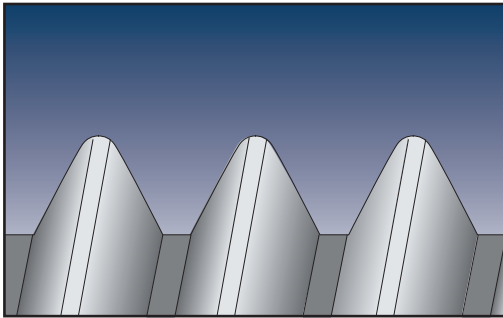

A thread which, when viewed axially, winds in a counterclockwise and receding direction. All left-hand threads are designated LH.

## Right-hand thread

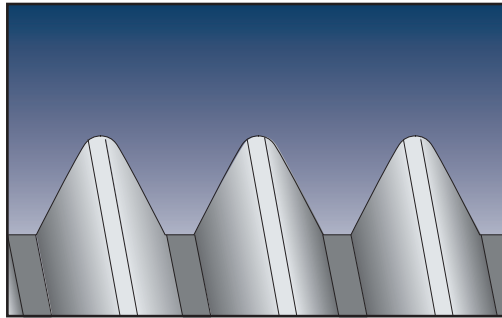

A thread which, when viewed axially, winds in a clockwise and receding direction. Threads are always right-hand unless otherwise specified.

## The Helix Angle $\beta$

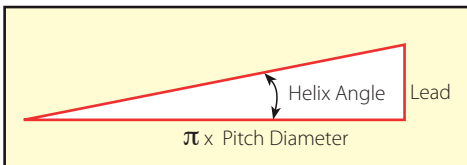

## Lead

The distance a threaded part moves axially, with respect to a fixed mating part, in one complete revolution.

The lead is equal to the pitch multiplied by the number of thread starts.

# Machining a Multi-Start Thread

A thread in which the lead is an integral multiple, greater than one, of the pitch.  
 A multi-start thread permits a more rapid advance without a coarser (larger) thread form.

First Start Machined

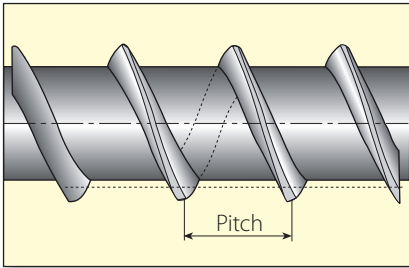

Second Start Machined

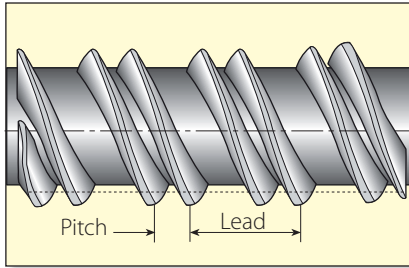

Third Start Machined  
(Final, 3 Starts Thread)

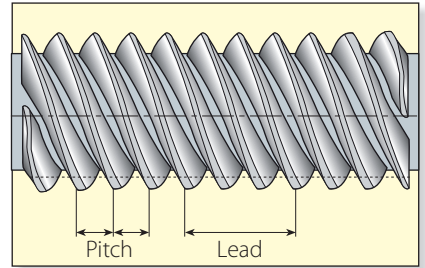

Lead = 3 x Pitch

## Insert Profile Styles

Partial Profile

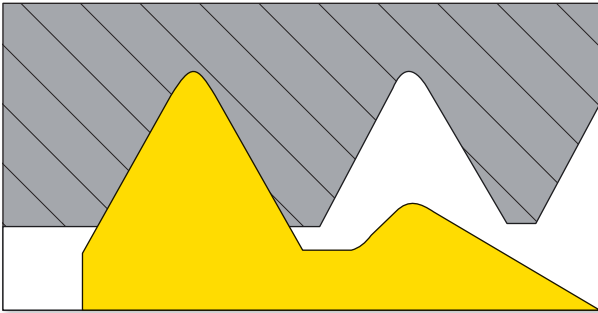

The V partial profile insert cuts without topping the outer diameter of the thread. The same insert can be used for a range of different thread pitches which have a common thread angle.

Full Profile

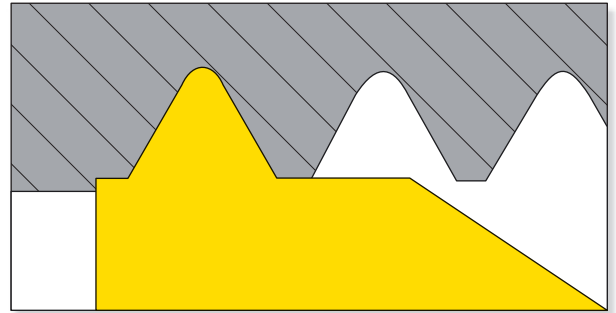

The full profile insert will form a complete thread profile including the crest. For every thread pitch and standard, a separate insert is required.

Full Profile for Fine Pitches

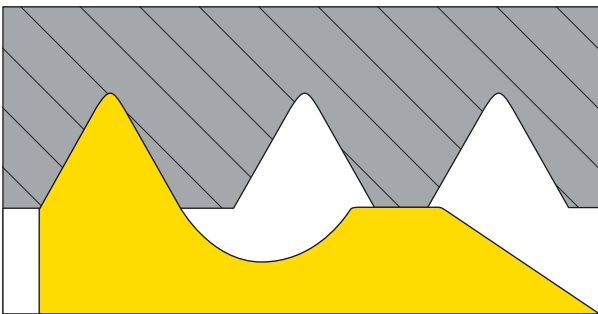

The full profile for Fine Pitches will form a complete thread. The topping of the outer diameter is generated by the second tooth.

Semi Full

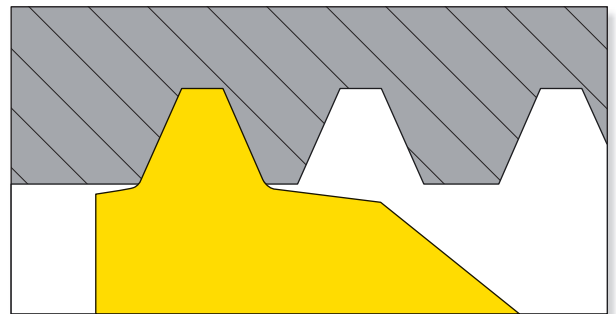

The Semi profile insert will form a complete thread including crest radius but without topping the outer diameter. Mainly used for trapezoidal profiles.

# Thread Turning Methods

Thread	Inserts & Toolholder	Rotation	Feed Direction	Helix Method	Drawing No.
Right Hand External	EX RH	Counterclockwise	Towards chuck	Regular	1
	EX LH	Clockwise	From chuck	Reversed	2
Right Hand Internal	IN RH	Counterclockwise	Towards chuck	Regular	3
	IN LH	Clockwise	From chuck	Reversed	4
Left Hand External	EX LH	Clockwise	Towards chuck	Regular	5
	EX RH	Counterclockwise	From chuck	Reversed	6
Left Hand Internal	IN LH	Clockwise	Towards chuck	Regular	7
	IN RH	Counterclockwise	From chuck	Reversed	8

External RH Thread

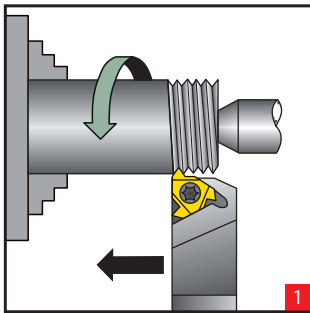

1

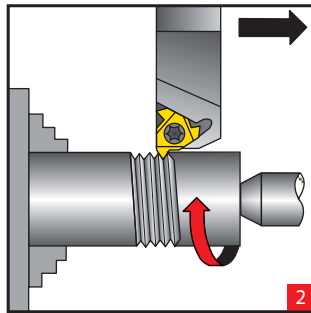

2

External LH Thread

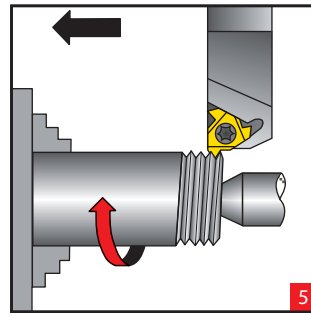

5

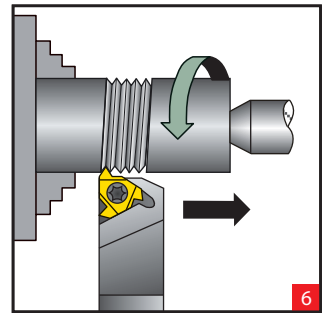

6

Internal RH Thread

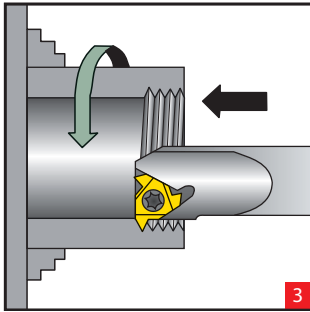

3

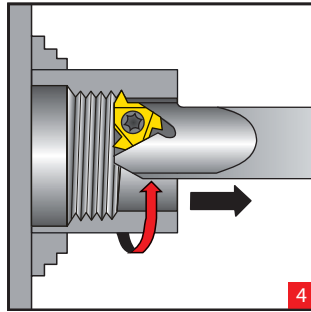

4

Internal LH Thread

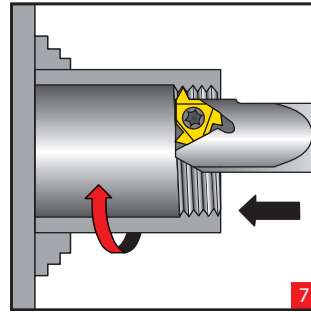

7

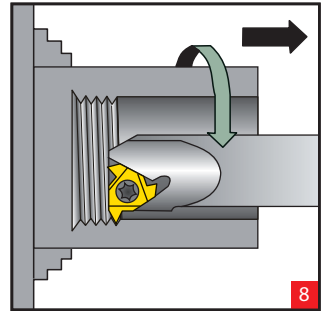

8

# Thread Infeed Methods

Radial Infeed

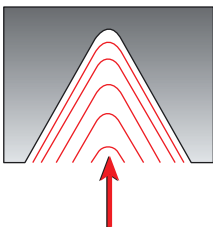

Radial infeed is the simplest and quickest method. The feed is perpendicular to the turning axis, and both flanks of the insert perform the cutting operation. Radial infeed is recommended in 3 cases:

- When the pitch is smaller than 16 tpi
- For material with short chips
- For work with hardened material

Flank Infeed (modified)

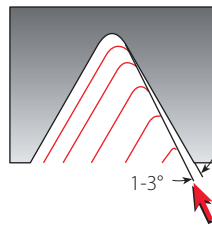

Flank infeed is recommended in the following cases:

- When the thread pitch is greater than 16 tpi, using the radial method, the effective cutting edge length is too large, resulting in chatter.
- For TRAPEZ and ACME. The radial method result in three cutting edges, making chip flow very difficult.

Alternate Flank Infeed

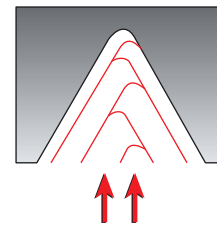

Use of the alternate flank method is recommended especially in large pitches and for materials with long chips. This method divides the load equally on both flanks, resulting in equal wear along the cutting edges. Alternate flank infeed requires more complicated programming, and is not available on all lathes.

# Calculating the Helix Angle and Choosing The Right Anvil

## Flank Clearance Angle $\alpha$ (For External Inserts)

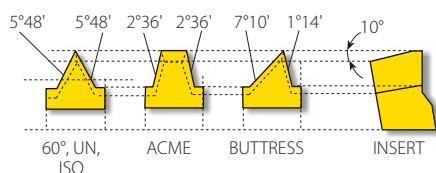

Vardex toolholders are designed to tilt the insert when seated in the toolholder (10° for external, 15° for internal tooling).

This results in the differing flank clearance angles, based on the geometry of the insert. To ensure that the side of the insert cutting edge will not rub on the workpiece, it is most important that the insert helix angle be correct - especially in profiles with small enclosed flank angles. This correction is provided by Vardex anvils.

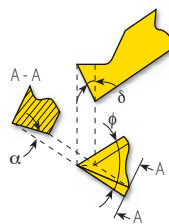

$$\alpha = \arctan(\tan \frac{\phi}{2} \times \tan \delta)$$

Where:  $\alpha$  - Flank clearance angle  
 $\delta$  - Tilt angle  
 $\phi$  - Enclosed flank angle

## Calculating the Helix Angle $\beta$

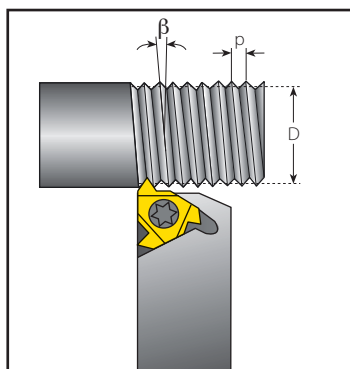

The helix angle is calculated by the following formula:

$$\beta = \arctan \frac{P \times N}{\pi \times D}$$

$\beta$  - Helix angle [°]  
 P - Pitch [mm]  
 N - No. of starts  
 D - Pitch diameter [mm]  
 Lead = P x N

The helix angle can also be found from the diagram below.

## Helix Angle Diagram

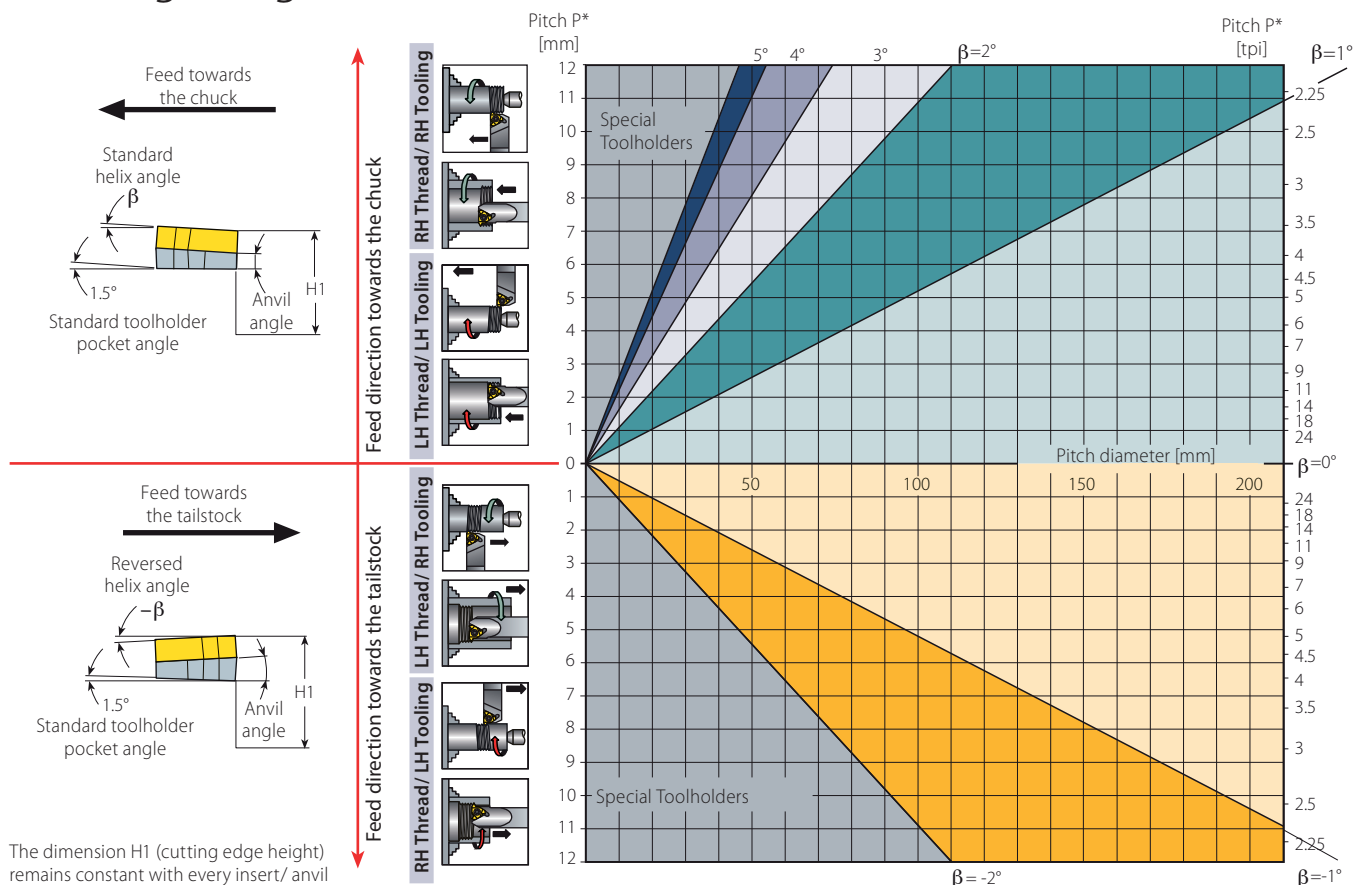

The dimension H1 (cutting edge height) remains constant with every insert/ anvil combination.

\*For Multi-start threads, use the lead value instead of the pitch

# Anvils

Resultant Helix Angle		4.5°	3.5°	2.5°	1.5°	0.5°	0°	-0.5°	-1.5°	
Insert Size	Holder	Ordering Code								
IC	L mm									
3/8"	16	ER / IL	YE3-3P	YE3-2P	YE3-1P	YE3	YE3-1N	YE3-1.5N	YE3-2N	YE3-3N
		EL / IR	YI3-3P	YI3-2P	YI3-1P	YI3	YI3-1N	YI3-1.5N	YI3-2N	YI3-3N
3/8" V6	16	ER	YE3-6C-3P	YE3-6C-2P	YE3-6C-1P	YE3-6C	YE3-6C-1N	YE3-6C-1.5N	YE3-6C-2N	YE3-6C-3N
		IR	YI3-6C-3P	YI3-6C-2P	YI3-6C-1P	YI3-6C	YI3-6C-1N	YI3-6C-1.5N	YI3-6C-2N	YI3-6C-3N
1/2"	22	ER / IL	YE4-3P	YE4-2P	YE4-1P	YE4	YE4-1N	YE4-1.5N	YE4-2N	YE4-3N
		EL / IR	YI4-3P	YI4-2P	YI4-1P	YI4	YI4-1N	YI4-1.5N	YI4-2N	YI4-3N
1/2"U	22	ER / IL	YE4U-3P	YE4U-2P	YE4U-1P	YE4U	YE4U-1N	YE4U-1.5N	YE4U-2N	YE4U-3N
		EL / IR	YI4U-3P	YI4U-2P	YI4U-1P	YI4U	YI4U-1N	YI4U-1.5N	YI4U-2N	YI4U-3N
5/8"	27	ER / IL	YE5-3P	YE5-2P	YE5-1P	YE5	YE5-1N	YE5-1.5N	YE5-2N	YE5-3N
		EL / IR	YI5-3P	YI5-2P	YI5-1P	YI5	YI5-1N	YI5-1.5N	YI5-2N	YI5-3N
5/8"U	27	ER / IL	YE5U-3P	YE5U-2P	YE5U-1P	YE5U	YE5U-1N	YE5U-1.5N	YE5U-2N	YE5U-3N
		EL / IR	YI5U-3P	YI5U-2P	YI5U-1P	YI5U	YI5U-1N	YI5U-1.5N	YI5U-2N	YI5U-3N
3/8"M	16	ER / IL			YE3M-1P	YE3M	YE3M-1N	YE3M-1.5N	YE3M-2N	
		EL / IR			YI3M-1P	YI3M	YI3M-1N	YI3M-1.5N		
1/2"M	22	ER / IL			YE4M-1P	YE4M	YE4M-1N	YE4M-1.5N	YE4M-2N	
		EL / IR			YI4M-1P	YI4M	YI4M-1N	YI4M-1.5N		
5/8"M	27	ER / IL				YE5M	YE5M-1N	YE5M-1.5N		
		EL / IR				YI5M	YI5M-1N	YI5M-1.5N		
1/2"Z	22	ER / IL			YE4Z-1P	YE4Z	YE4Z-1N			
		EL / IR			YI4Z-1P	YI4Z	YI4Z-1N			
5/8"Z	27	ER / IL				YE5Z				
		EL / IR				YI5Z				
1/2"T	22	ER / IL EL / IR					Y4T			

Standard Anvil		V6 Anvil		U Style Anvil		M Style Anvil		Z Style Anvil		T Style Anvil	
ER/IL	EL/IR	ER	IR	ER/IL	EL/IR	ER/IL	EL/IR	ER/IL	EL/IR	ER/IL	EL/IR
		V6 is indicated on the backside								Same anvil turned over	

## Anvil Kits

Anvil Size	Ordering Code	Included Anvils:	
IC	L mm		
3/8"	16	ABY3	YE3-2P, 1P, 1N, 2N, 3N YI3-2P, 1P, 1N, 2N, 3N
		ABY3-6C	YE3-6C-2P, 1P, 1N, 2N, 3N YI3-6C-2P, 1P, 1N, 2N, 3N
1/2"	22	ABY4	YE4-2P, 1P, 1N, 2N, 3N YI4-2P, 1P, 1N, 2N, 3N
		ABY4U	YE4U-2P, 1P, 1N, 2N, 3N YI4U-2P, 1P, 1N, 2N, 3N
5/8"	27	ABYE5	YE5-2P, 1P, 1N, 2N, 3N
		ABYI5	YI5-2P, 1P, 1N, 2N, 3N
5/8"U	27	ABYE5U	YE5U-2P, 1P, 1N, 2N, 3N
		ABYI5U	YI5U-2P, 1P, 1N, 2N, 3N

To ensure that you always have on hand an assortment of anvils for any job, we recommend that anvil kits be readily available.

**Important!**

**Use a V6 anvil when using a V6 insert.**





For External RH  
use YE3-6C anvil.





For Internal RH  
use YI3-6C anvil.



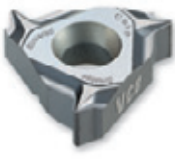





# Grades and Their Applications

General Use		
VKX	VTX	VCB
 <p>Superior general purpose grade, excellent in steels and stainless steels, recommended for rigid cutting conditions, ground or sintered chipbreaker styles. TiN coated.</p>	 <p>General purpose grade with tough submicron substrate. Provides good fracture toughness in non-rigid cutting conditions. TiAlN coated.</p>	 <p>Vardex sintered chipbreaker with ground profile for machining materials with long chips. TiAlN coated.</p>

Stainless Steel	Non Ferrous, High Temperature Alloys and Titanium	
VM7	VK2	VK2P
 <p>Specialty grade for threading stainless steel. Multi-layer PVD coated.</p>	 <p>Uncoated grade for non-ferrous, aluminium, high temperature and titanium alloys.</p>	 <p>Highly-polished version of the VK2 uncoated grade for high quality surface finish in aluminium.</p>

## MINIPRO

Micro & MicroScope	Mini "5L" & Mini IC 6.0	Mini IC 4.0
VMX	VHX	VTX
 <p>General purpose carbide grade for Micro double-ended inserts. TiN coated.</p>	 <p>HSS grade for Mini "L" and Mini 6.0 inserts; for low cutting speeds, TiN coated.</p>	 <p>Carbide grade for Mini 4.0. For machining stainless steel and general use. TiAlN coated.</p>
VBX	VKP	VBX
 <p>General purpose carbide grade for single-ended MicroScope inserts. TiCN coated.</p>	 <p>General purpose carbide grade for Mini "L" and Mini 6.0 inserts, TiN coated.</p>	 <p>Carbide grade for Mini 4.0. For machining steel and general use. TiCN coated.</p>

# Recommended Grades and Cutting Speeds Vc [m/min] not Including MiniPro Line

Material Group	Vardex No.	Material	Hardness Brinell HB	Vc [m/min]					
				Coated				Uncoated VK2 / VK2P	
				VKX	VCB	VM7	VTX		
<b>P</b> Steel	1	Unalloyed steel	Low carbon (C=0.1-0.25%)	125	115-190	115-190		115-190	
	2		Medium carbon (C=0.25-0.55%)	150	100-175	100-165		100-175	
	3		High carbon (C=0.55-0.85%)	170	90-165	90-155		90-165	
	4	Low alloy steel (alloying elements ≤5%)	Non hardened	180	100-180	100-180		100-180	
	5		Hardened	275	75-140	75-140		75-140	
	6		Hardened	350	70-135	70-135		70-135	
	7	High alloy steel (alloying elements >5%)	Annealed	200	80-120	80-120		80-120	
	8		Hardened	325	50-100	50-100		50-100	
	9	Cast steel	Low alloy (alloying elements <5%)	200	70-130	70-130		70-130	
	10		High alloy (alloying elements >5%)	225	60-120	60-120		60-120	
<b>M</b> Stainless Steel	11	Stainless steel Ferritic	Non hardened	200	70-130	70-130	70-150	70-130	
	12		Hardened	330	60-115	50-95	60-125	60-115	
	13	Stainless steel Austenitic	Austenitic	180	90-140	80-120	90-160	90-140	
	14		Super Austenitic	200	40-110	30-100	40-120	40-110	
	15	Stainless steel Cast ferritic	Non hardened	200	90-120	90-120	90-150	90-120	
	16		Hardened	330	65-110	65-110	65-120	65-110	
	17	Stainless steel Cast austenitic	Austenitic	200	85-110	85-110	85-120	85-110	
	18		Hardened	330	60-100	60-100	60-110	60-100	
<b>K</b> Cast Iron	28	Malleable Cast iron	Ferritic (short chips)	130	60-70	70-120		60-70	
	29		Pearlitic (long chips)	230	60-145	70-120		60-145	
	30	Grey Cast iron	Low tensile strength	180	70-130	70-130		70-130	
	31		High tensile strength	260	60-115	60-100		60-115	
	32	Nodular SG iron	Ferritic	160	125-160	125-160		125-160	
	33		Pearlitic	260	90-120	90-120		90-120	
<b>N(K)</b> Non-Ferrous Metals	34	Aluminium alloys Wrought	Non aging	60	100-365	100-250		100-365	100-250
	35		Aged	100	80-220	80-180		80-220	80-160
	36	Aluminium alloys	Cast	75	200-400	200-400		200-400	80-120
	37		Cast & aged	90	200-280	200-280		200-280	70-100
	38		Cast Si 13-22%	130	60-180	60-150		60-180	50-120
	39	Copper and copper alloys	Brass	90	80-225	80-210		80-225	70-170
	40		Bronze and non leaded copper	100	80-255	80-210		80-255	70-170
<b>S(M)</b> Heat Resistant Material	19	High temperature alloys	Annealed (Iron based)	200	45-60	45-60		45-60	30-50
	20		Aged (Iron based)	280	30-50	30-50		30-50	25-40
	21		Annealed (Nickel or Cobalt based)	250	20-30	20-30		20-30	20-30
	22		Aged (Nickel or Cobalt based)	350	15-25	15-25		15-25	15-25
	23	Titanium alloys	Pure 99.5 Ti	400Rm	140-170	140-170		140-170	60-100
24	α+β alloys		1050Rm	50-70	50-70		50-70	40-60	
<b>H(K)</b> Hardened Material	25	Extra hard steel	Hardened & tempered	45-50HRC	45-60	45-60		45-60	
	26			51-55HRC	40-50	40-50		40-50	

Thread Turning  
Technical Data

## Calculation of N [RPM]

$$N = \frac{1000 \times V_c}{\pi \times D}$$

$$V_c = \frac{N \times \pi \times D}{1000}$$

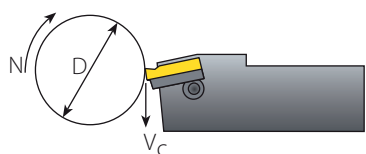

N - Revolution Per Minute [RPM]  
V<sub>c</sub> - Cutting Speed [m/min]  
D - Workpiece Diameter [mm]

## Recommended Grades and Cutting Speeds Vc [m/min] Mini, Micro and Microscope

Material Group	Vardex No.	Material	Hardness Brinell HB	Vc [m/min]				
				Coated				
				VMX (Micro)	VKP/VBX (Mini&Microscope)	VTX (Mini)	VHX (Mini)	
<b>P</b> Steel	1	Unalloyed steel	Low carbon (C=0.1-0.25%)	125	50-120	140-200	150-200	20-50
	2		Medium carbon (C=0.25-0.55%)	150	40-100	120-180	130-180	15-40
	3		High Carbon (C=0.55-0.85%)	170	30-80	110-180	120-180	15-30
	4	Low alloy steel (alloying elements ≤5%)	Non hardened	180	50-70	100-155	110-155	20-45
	5		Hardened	275	40-60	90-145	100-145	10-25
	6		Hardened	350	30-50	80-135	90-135	10-25
	7	High alloy steel (alloying elements >5%)	Annealed	200	30-50	65-115	70-115	
	8		Hardened	325	25-40	50-100	60-100	
	9	Cast steel	Low alloy (alloying elements <5%)	200	30-50	30-50	30-50	25-40
	10		High alloy (alloying elements >5%)	225	25-40	25-40	30-40	25-40
<b>M</b> Stainless Steel	11	Stainless steel Ferritic	Non hardened	200	60-100	80-120	90-120	
	12		Hardened	330	40-60	55-95	60-95	
	13	Stainless steel Austenitic	Austenitic	180	50-90	60-100	70-100	
	14		Super Austenitic	200	40-60	50-90	60-90	
	15	Stainless steel Cast Ferritic	Non hardened	200	40-60	60-80	70-80	
	16		Hardened	330	30-50	45-65	50-65	
	17	Stainless steel Cast austenitic	Austenitic	200	40-60	50-70	60-70	
	18		Hardened	330	30-50	40-60	40-60	
<b>K</b> Cast Iron	28	Malleable Cast iron	Ferritic (short chips)	130	50-70	60-80	70-80	
	29		Pearlitic (long chips)	230	50-70	60-80	70-80	
	30	Grey cast iron	Low tensile strength	180	50-70	60-80	70-80	
	31		High tensile strength	260	40-60	40-70	40-70	
	32	Nodular SG iron	Ferritic	160	50-70	60-80	70-80	
	33		Pearlitic	260	60-80	70-90	80-90	
<b>N(K)</b> Non-Ferrous Metals	34	Aluminium alloys Wrought	Non aging	60	100-300	80-240	90-240	30-60
	35		Aged	100	100-150	100-170	110-170	25-50
	36	Aluminium alloys	Cast	75	100-150	100-150	110-150	25-50
	37		Cast & aged	90	60-100	60-100	70-100	20-40
	38	Aluminium alloys	Cast Si 13-22%	130	100-150	100-150	110-150	15-30
	39	Copper and copper alloys	Brass	90	60-100	80-200	90-200	15-35
	40		Bronze and non leaded copper	100	60-100	80-200	90-200	15-35
	<b>S(M)</b> Heat Resistant Material	19	High temperature alloys	Annealed (Iron based )	200	25-45	25-45	30-45
20		Aged (Iron based)		280	20-30	20-30	20-30	
21		Annealed (Nickel or Cobalt based)		250	15-20	15-20	15-20	
22		Aged (Nickel or Cobalt based)		350	10-15	10-15	15-20	
23		Titanium alloys	Pure 99.5 Ti	400Rm	60-100	60-100	70-100	
24			α+β alloys	1050Rm	40-50	40-50	40-50	
<b>H(K)</b> Hardened Material	25	Extra hard steel	Hardened & tempered	45-50HRc	20-40	20-40	20-40	
	26			51-55HRc	20-40	20-40	20-40	



## Number of Passes

Pitch	mm	0.50	0.75	1.00	1.25	1.50	1.75	2.00	2.50	3.00	3.50	4.00	4.50	5.00	5.50	6.00	8.00
	tpi	48	32	24	20	16	14	12	10	8	7	6	5.5	5	4.5	4	3
No. of passes		4-6	4-7	4-8	5-9	6-10	7-12	7-12	8-14	9-16	10-18	11-18	11-19	12-20	12-20	12-20	15-24
No. of passes (SCB)		3-4	3-4	3-5	4-6	5-6	6-8	6-8	8-10	9-12	10-14						
No. of passes (Micro / Scope & Mini)		6-9	6-11	6-12	8-14	9-15	11-18	11-18									

## Cutting Conditions Depends On:

<b>Workpiece</b>	Material Type	
	Material Dimension: Diameter and Length	
	Chipflow Character	
	Material Hardness	
<b>Thread Application</b>	External or Internal	
	Profile Shape	
	Surface Finish	
<b>Machine</b>	Machine Stability	
	Max. RPM	
	Clamping System Stability	
<b>Coolant</b>	Coolant Type	
<b>Holder</b>	Holder Cross Section Area	
	Holder Overhang	
	Through Coolant Option	
	Shank Type: Carbide, Alloy, Carbide Implant	
<b>Insert</b>	Grade	
	Profile Shape: Pitch and Depth	
	Nose Radius	
	Chipbreaker Style	

# Number of Passes and Depth of Cut per Pass for Multi+ Inserts



Standard	Insert Type	Insert Size		Pitch	Teeth	Ordering Code	Passes	Depth of cut per pass			
		IC	L mm					RH			
								1	2	3	4
ISO External	M+	3/8"	16	1.0 mm	3	3ER1.0ISO3M+...	2	0.32	0.30		
				1.5 mm	2	3ER1.5ISO2M+...	3	0.34	0.30	0.29	
				2.0 mm	2	3ER2.0ISO2M+...	3	0.45	0.40	0.38	
		1/2"	22	1.5 mm	3	4ER1.5ISO3M+...	2	0.48	0.45		
				2.0 mm	2	4ER2.0ISO2M+...	3	0.45	0.40	0.38	
				2.0 mm	3	4ER2.0ISO3M+...	2	0.64	0.59		
	2.5 mm	2	4ER2.5ISO2M+...	4	0.46	0.42	0.38	0.36			
	5/8"	27	3.0 mm	2	5ER3.0ISO2M+...	4	0.53	0.47	0.45	0.39	
	T+	1/2"T	22	1.5 mm	8	4ER1.5ISO8T+...	1	0.93			
				2.0 mm	8	4ER2.0ISO8T+...	1	1.23			
ISO Internal	M+	3/8"	16	1.0 mm	3	3IR1.0ISO3M+...	2	0.30	0.28		
				1.5 mm	2	3IR1.5ISO2M+...	3	0.31	0.28	0.27	
				2.0 mm	2	3IR2.0ISO2M+...	3	0.42	0.37	0.36	
		1/2"	22	1.5 mm	3	4IR1.5ISO3M+...	2	0.45	0.41		
				2.0 mm	2	4IR2.0ISO2M+...	3	0.42	0.37	0.36	
				2.0 mm	3	4IR2.0ISO3M+...	2	0.59	0.56		
	5/8"	27	3.0 mm	2	5IR3.0ISO2M+...	4	0.49	0.45	0.42	0.37	
	T+	1/2"	22	1.5 mm	8	4IR1.5ISO8T+...	1	0.86			
				2.0 mm	8	4IR2.0ISO8T+...	1	1.15			
	UN External	M+	3/8"	16	20 tpi	3	3ER20UN3M+...	2	0.41	0.38	
18 tpi					2	3ER18UN2M+...	3	0.32	0.28	0.27	
18 tpi					3	3ER18UN3M+...	2	0.45	0.42		
16 tpi					2	3ER16UN2M+...	3	0.36	0.32	0.30	
14 tpi					2	3ER14UN2M+...	3	0.43	0.38	0.37	
12 tpi					2	3ER12UN2M+...	3	0.47	0.43	0.40	
1/2"		22	16 tpi	3	4ER16UN3M+...	2	0.51	0.47			
			14 tpi	2	4ER14UN2M+...	3	0.43	0.38	0.37		
			12 tpi	2	4ER12UN2M+...	3	0.47	0.43	0.40		
			12 tpi	3	4ER12UN3M+...	2	0.67	0.63			
11 tpi	2	4ER11UN2M+...	4	0.43	0.38	0.36	0.32				
10 tpi	2	4ER10UN2M+...	4	0.46	0.42	0.40	0.36				
5/8"	27	8 tpi	2	5ER8UN2M+...	4	0.56	0.50	0.48	0.41		
UN Internal	M+	3/8"	16	12 tpi	2	3IR12UN2M+...	3	0.45	0.39	0.38	
				14 tpi	2	3IR14UN2M+...	3	0.41	0.36	0.34	
				16 tpi	2	3IR16UN2M+...	3	0.33	0.30	0.28	
	1/2"	22	16 tpi	3	4IR16UN3M+...	2	0.47	0.44			
			14 tpi	2	4IR14UN2M+...	3	0.41	0.36	0.34		
			12 tpi	2	4IR12UN2M+...	3	0.45	0.39	0.38		
			12 tpi	3	4IR12UN3M+...	2	0.63	0.59			
5/8"	27	8 tpi	2	5IR8UN2M+...	4	0.52	0.47	0.44	0.38		
BSW External	M+	3/8"	16	28 tpi	2	3ER28W2M+...	3	0.23	0.20	0.20	
				19 tpi	2	3ER19W2M+...	3	0.33	0.28	0.27	
				19 tpi	3	3ER19W3M+...	2	0.45	0.41		
				14 tpi	2	3ER14W2M+...	3	0.43	0.38	0.35	
		1/2"	22	14 tpi	3	4ER14W3M+...	2	0.60	0.56		
				11 tpi	2	4ER11W2M+...	4	0.44	0.38	0.36	0.30

# Number of Passes and Depth of Cut per Pass for Multi+ Inserts



Standard	Insert Type	Insert Size		Pitch	Teeth	Ordering Code	Passes	Depth of cut per pass				
		IC	L mm					1	2	3	4	
BSW Internal	M+	3/8"	16	14	tpi	2	3IR14W2M+...	3	0.43	0.38	0.35	
		1/2"	22	11	tpi	2	4IR11W2M+...	4	0.44	0.38	0.36	0.30
NPT External	M+	3/8"	16	14	tpi	2	3ER14NPT2M+...	3	0.52	0.45	0.43	
		1/2"	22	11.5	tpi	2	4ER11.5NPT2M+...	4	0.46	0.43	0.42	0.40
		5/8"	27	11.5	tpi	3	5ER11.5NPT3M+...	4	0.48	0.43	0.42	0.38
	Z+	1/2"	22	11.5	tpi	2	4ER11.5NPT2Z+...	4	0.46	0.43	0.42	0.40
				8	tpi	2	4ER8NPT2Z+...	4	0.72	0.64	0.60	0.53
		5/8"	27	8	tpi	2	5ER8NPT2M+...	4	0.72	0.64	0.60	0.53
NPT Internal	M+	3/8"	16	14	tpi	2	3IR14NPT2M+...	3	0.52	0.45	0.43	
		1/2"	22	11.5	tpi	2	4IR11.5NPT2M+...	4	0.46	0.43	0.42	0.40
		5/8"	27	11.5	tpi	2	5IR11.5NPT3M+...	4	0.48	0.43	0.42	0.38
	Z+	1/2"	22	11.5	tpi	3	4IR11.5NPT2Z+...	4	0.46	0.43	0.42	0.40
				8	tpi	2	4IR8NPT2Z+...	4	0.72	0.64	0.60	0.53
		5/8"	27	8	tpi	2	5IR8NPT2M+...	4	0.72	0.64	0.60	0.53
NPTF External	M+	3/8"	16	14	tpi	2	3ER14NPTF2M+...	3	0.51	0.44	0.42	
NPTF Internal	M+	3/8"	16	14	tpi	2	3IR14NPTF2M+...	3	0.51	0.44	0.42	
API BUT External	M+	5/8"	27	5	tpi	2	5ER5BUT752M+...	4	0.46	0.41	0.39	0.33
	T+	1/2"	22	5	tpi	3	4ER5BUT753T+...	3	0.57	0.52	0.50	
API BUT Internal	M+	5/8"	27	5	tpi	2	5IR5BUT752M+...	4	0.46	0.41	0.39	0.33
	T+	1/2"	22	5	tpi	3	4IR5BUT753T+...	3	0.57	0.52	0.50	
API RD External	M+	5/8"	27	10	tpi	3	5ER10APIRD3M+...	2	0.74	0.69		
				8	tpi	2	5ER8APIRD2M+...	3	0.66	0.60	0.58	
				10	tpi	6	4ER10APIRD6T+...	2	0.71	0.71		
	T+	1/2"	22	8	tpi	3	4ER8APIRD3T+...	2	0.94	0.90		
				8	tpi	5	4ER8APIRD5T+...	2	0.94	0.90		
				10	tpi	2	4IR10APIRD2M+...	3	0.52	0.46	0.45	
API RD Internal	M+	1/2"	22	8	tpi	2	4IR8APIRD2M+...	3	0.66	0.60	0.58	
				10	tpi	3	5IR10APIRD3M+...	3	0.48	0.48	0.47	
				8	tpi	2	5IR8APIRD2M+...	3	0.66	0.60	0.58	
	Z+	1/2"	22	8	tpi	2	4IR8APIRD2Z+...	3	0.66	0.60	0.58	
				10	tpi	6	4IR10APIRD6T+...	2	0.71	0.71		
				8	tpi	3	4IR8APIRD3T+...	2	0.94	0.90		
T+	1/2"	22	8	tpi	5	4IR8APIRD5T+...	2	0.94	0.90			

Thread Turning  
Technical Data



M+ Style insert



T+ Style insert



Z+ Style insert

# Step by Step Thread Turning - Example 1

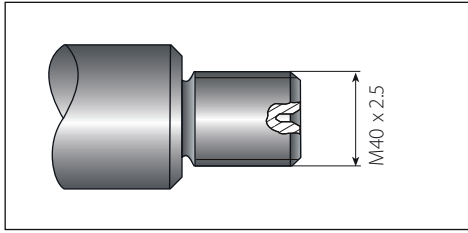

Application:  
 Thread: External Right Hand  
 ISO Metric M40x2.5  
 Material: 4140 (25 HRC)

## 1 Choose the Thread Turning Method

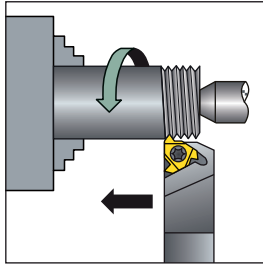

Feed direction towards the chuck was chosen.  
 Therefore, an external right hand insert and an external right hand holder will be used.

## 2 Choose the Insert Size

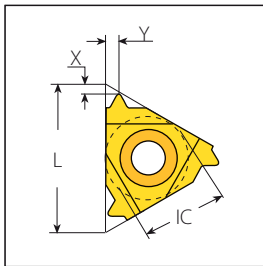

Chosen insert: 3ER2.5ISO

Insert Size	Pitch	Ordering Code	Anvil	Toolholder
IC	L mm	mm	RH	RH
3/8"	16	2.5	3ER2.5ISO ...	YE3 AL..-3(LH)

## 3 Choose the Toolholder

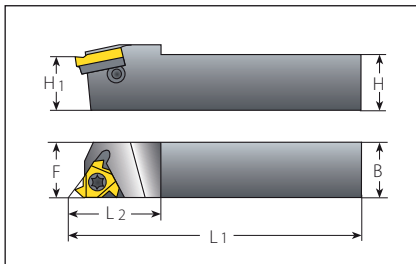

Chosen toolholder: AL 25-3

Insert Size	Ordering Code	Dimensions mm			
IC	RH	H=H1=B	F	L1	L2
3/8"	AL 25-3	25	25	153.6	30

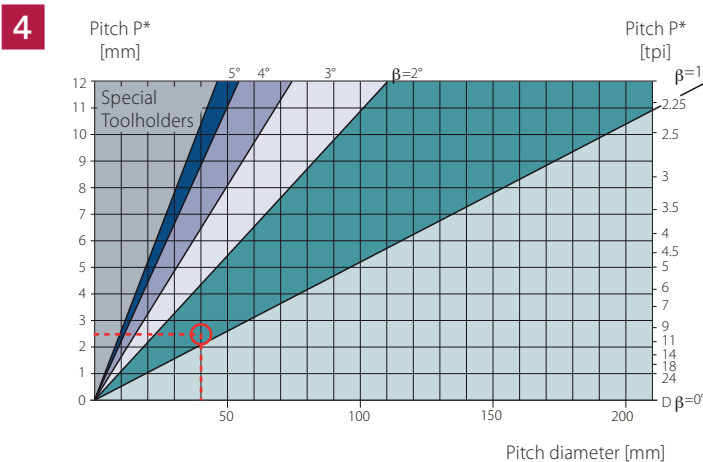

From the table, using a pitch of 2.5 mm (10 tpi) and a workpiece diameter of 40 mm (1.57"), we find the helix angle to be 1.5°.

## 5 Choose the Correct Anvil

Anvil chosen: YE3

Resultant Helix Angle

3.5

2.5

**1.5**

0.5

Insert Size	Ordering Code	Holder	Ordering Code			
IC	L mm					
3/8"	16	ER/IL	YE3-2P	YE3-1P	<b>YE3</b>	YE3-1N

## 6 Choose the carbide grade and cutting speed

Carbide Grade chosen: VTX

Cutting Speed: 140 m/min

Material:		Hardness Brinell HB	VTX	VCB	
<b>P</b>	Low alloy steel (alloying elements ≤ 5%)	Non hardened	180	85-145	100-180
		Hardened	275	75-140	75-140
		Hardened	350	70-135	70-135

## 7 Determine the Number Of Passes

Numbers of passes: 10

### ISO External

Pitch	mm	1.50	1.75	2.00	<b>2.50</b>	3.00	3.50	4.00
	tpi	16	14	12	10	8	7	6
No. of passes		6-10	7-12	7-12	<b>8-14</b>	9-16	10-18	11-18

## Summary

Thread Type	ISO M40x2.5 External Right Hand
<b>1</b> Feed Direction:	<b>Towards the chuck</b>
<b>2</b> Insert and Grade:	<b>3ER2.5ISO VTX</b>
<b>3</b> Toolholder:	<b>AL 25 - 3</b>
<b>4</b> Helix Angle:	<b>1.5°</b>
<b>5</b> Anvil:	<b>YE3</b>
<b>6</b> Cutting Speed:	<b>140 m/min</b>
<b>7</b> Number of Passes:	<b>14</b>

# Step by Step Thread Turning - Example 2

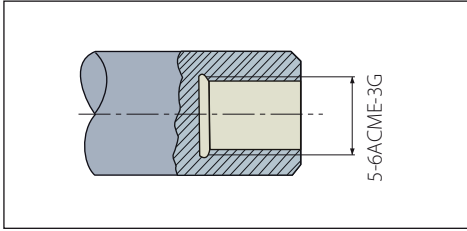

Application:  
 Thread: Internal Right Hand  
 ACME  
 Pitch: 6 tpi  
 Bore dia: 5"  
 Material: Stainless Steel Austemritic

## 1 Choose the Thread Turning Method

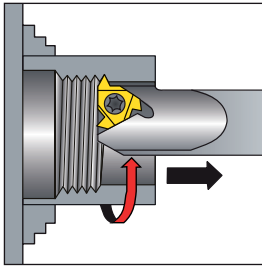

To facilitate the removal of chips from the machined area, we chose a feed direction away from the chuck. Therefore, an internal left hand insert and an internal left hand toolholder are to be used.

## 2 Choose the Insert size

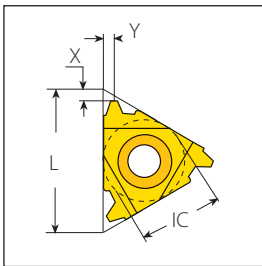

Chosen insert: 4IL6ACME

Insert Size	Pitch	Ordering Code	Anvil	Toolholder
IC	L mm	tpi	RH	LH
1/2"	22	6	4IL6ACME...	YE4 AVR..-4(LH)

## 3 Choose the Toolholder

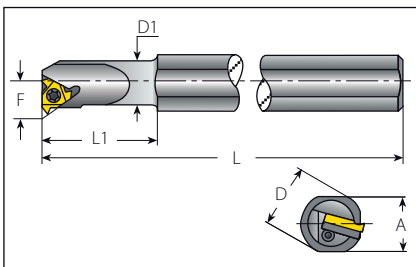

Chosen toolholder: AVR 40-4LH

Insert Size	Ordering Code	Dimensions mm					Min Bore	
IC	RH	A	L	L1	D	D1	F	mm
1/2"	AVR 40-4	36.0	300	60	40	40.0	25.8	47

## 4 Determine the Helix Angle

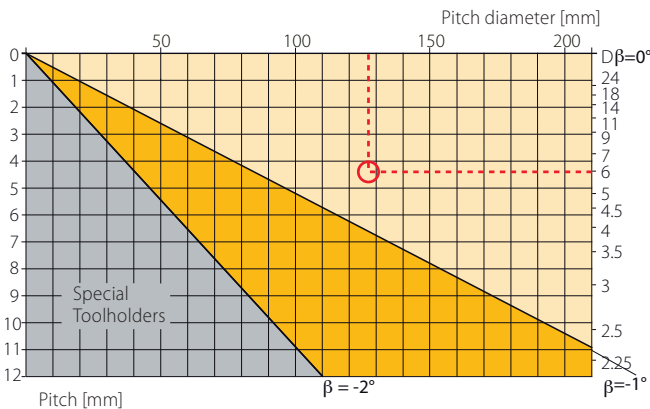

In this case, a right hand thread is being turned with a left hand toolholder. The reverse helix method is used. From the lower part of the table, using a pitch of 6 tpi and a bore diameter of 127mm, we obtain a helix angle of **-0.65°**.

## 5 Choose the Correct Anvil

Anvil chosen: YE4-2N

Insert Size		Ordering Code					
IC	L mm	ER/IL	YE4	YE4-1N	YE4-1.5N	<b>YE4-2N</b>	YE4-3N
1/2"	22	ER/IL	YE4	YE4-1N	YE4-1.5N	<b>YE4-2N</b>	YE4-3N

## 6 Choose the carbide grade and cutting speed

Carbide grade chosen: VTX  
Cutting speed: 140 m/min

	Material:	Hardness Brinell HB	<b>VTX</b>	VCB
<b>M</b>	Stainless steel	Austenitic	180	90-140
	Austenitic	Super austenitic	200	40-110
				80-120
				30-100

## 7 Determine The Number Of Passes

Numbers of passes: 18

### ACME External & Internal

Pitch	mm	3.00	3.50	4.00	4.50	5.00	5.50	6.00
	tpi	8	7	<b>6</b>	5.5	5	4.5	4
No. of passes		9-16	10-18	<b>11-18</b>	11-19	12-20	12-20	12-20

## Summary

Thread Type	5"x6 ACME Internal Right Hand
<b>1</b> Feed Direction:	<b>Away from the chuck</b>
<b>2</b> Insert and Grade:	<b>4IL6ACME VTX</b>
<b>3</b> Toolholder:	<b>AVR 40-4LH</b>
<b>4</b> Helix Angle:	<b>-0.65°</b>
<b>5</b> Anvil:	<b>YE4-2N</b>
<b>6</b> Cutting Speed:	<b>140 m/min</b>
<b>7</b> Number of Passes:	<b>18</b>

# Material Comparison Table

Material Group	Vardex No.	USA AISI/SAE	Germany W.-Nr.	Germany DIN	Great Britain BS	France AFNOR	Italy UNI
P Steel	1	1015	1.0037	St37-2	Fe360B	E24-2	Fe360 B FU
	1	1020	1.0044	St44-2	Fe430B FN	E28-2	Fe430B FN
	2	ASTM A570Gr.50	1.0050	St50-2	Fe490-2 FN	A50-2	Fe490
	2	-	1.0070	St70-2	Fe690-2 FN	A70-2	Fe690
	1	1015	1.0401	C15	080M15	CC12	C15C16
	1	1020	1.0402	C22	050A20	CC20	C20C21
	2	1035	1.0501	C35	060A35	CC35	C35
	2	1045	1.0503	C45	080M46	CC45	C45
	2	1055	1.0535	C55	070M55	-	C55
	2	1060	1.0601	C60	080A62	CC55	C60
	1	1213	1.0715	9SMn28	230M07	S250	CF95Mn28
	1	12L13	1.0718	9SMnPb28	-	S250Pb	CF95MnPb28
	1	-	1.0722	10SPb20	-	10PbF2	CF10SPb20
	2	1140	1.0726	35S20	212M36	35MF4	-
	2	1215	1.0736	9SMn36	240M07	S300	CF95Mn36
	2	12L14	1.0737	9SMnPb36	-	S300Pb	CF95MnPb36
	2	9255	1.0904	55Si7	250A53	55S7	55Si8
	2	9262	1.0961	60SiCr7	-	60SiC7	60SiCr8
	1	1015	1.1141	Ck15	080M15	XC1 2	C16
	2	1039	1.1157	40Mn4	150M36	35M5	-
	2	1025	1.1158	Ck25	-	-	-
	2	1335	1.1167	36Mn5	-	40M5	-
	2	1330	1.1170	28Mn6	150M28	20M5	C28Mn
	2	1035	1.1183	Cf35	060A35	XC38TS	C36
	2	1045	1.1191	Ck45	080M46	XC42	C45
	2	1055	1.1203	Ck55	070M55	XC55	C50
	3	1050	1.1213	Cf53	060A52	XC48TS	C53
	3	1060	1.1221	Ck60	080A62	XC60	C60
	8	1095	1.1274	Ck101	060A96	-	-
	9	-	1.3401	X120Mn12	Z120M12	Z120M12	XG120Mn12
	8	52100	1.3505	100Cr6	534A99	100C6	100Cr6
	8	ASTM A20Gr.A	1.5415	15Mo3	1501-240	15D3	16Mo3KW
	8	4520	1.5423	16Mo5	1503-245-420	-	16Mo5
	4	ASTMA350LF5	1.5622	14Ni6	-	16N6	14Ni6
	8	ASTM A353	1.5662	X8Ni9	1501-509; 510	-	X10Ni9
	8	2515	1.5680	12Ni19	-	Z18N5	-
	5	3135	1.5710	36NiCr6	640A35	35NC6	-
	5	3415	1.5732	14NiCr10	-	14NC11	16NiCr11
	5	3415; 3310	1.5752	14NiCr14	655M13; 655M12	12NC15	-
	5	9840	1.6511	36CrNiMo4	816M40	40NCD3	38NiCrMo4(KB)
	5	8620	1.6523	21NiCrMo2	805M20	20NCD2	20NiCrMo2
	5	8740	1.6546	40NiCrMo22	311-Type7	-	40NiCrMo2(KB)
	5	4340	1.6582	34CrNiMo6	817M40	35NCD6	35NiCrMo6(KB)
	5	-	1.6587	17CrNiMo6	820A16	18NCD6	-
	5	-	1.6657	14NiCrMo134	832M13	-	15NiCrMo13
	2	5015	1.7015	15Cr3	523M15	12C3	-
	5	5132	1.7033	34Cr4	530A32	32C4	34Cr4(KB)
	5	5140	1.7035	41Cr4	530M40	42C4	41Cr4
	5	5140	1.7045	42Cr4	-	-	-
	5	5115	1.7131	16MnCr5	(527M20)	16MC5	16MnCr5
5	5155	1.7176	55Cr3	527A60	55C3	-	
5	4130	1.7218	25CrMo4	1717CDS110	25CD4	25CrMo4(KB)	
5	4137; 4135	1.7220	34CrMo4	708A37	35CD4	35CrMo4	
5	4140; 4142	1.7223	41CrMo4	708M40	42CD4TS	41CrMo4	
5	4140	1.7225	42CrMo4	708M40	42CD4	42CrMo4	
5	-	1.7262	15CrMo5	-	12CD4	-	
5	ASTM A182; F11; F12	1.7335	13CrMo4 4	1501-620Gr.27	15CD3.5; 15CD4.5	14CrMo4 5	
5	-	1.7361	32CrMo12	722M24	30CD12	32CrMo12	
5	ASTM A182; F22	1.7380	10CrMo9 10	1501-622; Gr.31; 45	12CD9; 10	12CrMo9, 10	
5	-	1.7715	14MoV6 3	1503-660-440	-	-	
5	6150	1.8159	50CrV4	735A50	50CV4	50CrV4	
8	-	1.8509	41CrAlMo7	905M39	40CAD6, 12	41CrAlMo7	
8	-	1.8523	39CrMoV13 9	897M39	-	36CrMoV12	
5	W.110	1.1545	C105W1	-	Y1105	C98KU; C100KU	
5	W.112	1.1663	C125W	-	Y2120	C120KU	
8	L3	1.2067	100Cr6	BL3	Y100C6	-	
10	D3	1.2080	X210Cr12	BD3	Z200Cr12	X210Cr13KU	
10	-	-	-	-	-	X250Cr12KU	
10	-	1.2311	40CrMnMo7	-	-	35CrMo8KU	
10	-	1.2312	40CrMnMoS8-6	-	-	-	
10	H11	1.2343	X38CrMoV5-1	BH11	Z38CDV5	X37CrMoV51 1KU	
10	H13	1.2344	X40CrMoV5-1	BH13	Z40CDV5	X35CrMoV05KU	
10	-	-	-	-	-	X40CrMoV511KU	
10	A2	1.2363	X100CrMoV5-1	BA2	Z1 00CDV5	X100CrMoV51KU	
10	-	1.2367	X38CrMoV5-3	-	Z38CDV5-3	-	
10	D2	1.2379	X155CrVMo 12-1	BD2	Z160CDV12	X155CrVMo12 1 KU	
10	-	1.2419	105WCr6	-	105WC13	10WCr6; 107WCr5KU	
10	-	1.2436	X210CrW12	-	-	X215CrW121KU	
10	S1	1.2542	45WCrV17	BS1	-	45WCrV8KU	
10	H21	1.2581	X30WCrV9 3	BH21	Z30WCV9	X30WCrV9 3KU	
10	-	1.2601	X165CrMoV12	-	-	X165CrMoV12KU	
10	L6	1.2713	55NiCrMoV6	-	55NCDV7	-	
10	-	1.2738	40CrMnNiMo8-6-4	-	-	-	
10	W210	1.2833	100V1	BW2	Y1105V; 100V2	-	
10	-	1.3243	S 6-5-2-5	-	Z85WDCV-06-05-05-04-02	HS 6-5-2-5	
10	T4	1.3255	S 18-1-2-5	BT4	Z80WKCV-18-05-04-01	X78WCo1805KU	
10	M2	1.3343	S 6-5-2	BM2	Z85WDCV-06-05-04-02	X82WCo0605KU	
10	M7	1.3348	S 2-9-2	-	Z100WCVV-09-04-02-02	HS 2-9-2	
10	T1	1.3355	S 18-0-1	BT1	Z80WCV-18-04-01	X75W18KU	

Thread Turning  
Technical Data



Sweden SS	Japan JIS	Russia GOST	Spain UNE	Vardex No.
1311	STKM 12A;C	–	Fe360B	1
1412	SM400A;B;C	St4ps;sp	Fe430B FN	1
1550	SS490	St5ps;sp	A490-2	2
–	–	–	A690-2	2
1350	–	–	F.111	1
1450	–	20	1 C 22 ; F.112	1
1550	–	30	F.113	2
1650	–	45	F.114	2
1655	–	55	F.115	2
–	–	60(G)	–	2
1912	SUM22	–	F.2111-11SMn28	1
1914	SUM22L	–	F.2112-11SMnPb28	1
–	–	–	F.2122-10SPb20	1
1957	–	–	F.210.G	2
–	–	–	F.2113-12SMn35	2
1926	–	–	F.2114-12SMnPb35	2
2085	–	55S2	F.1440-56Si7	2
–	–	–	F.1442-60SiCr8	2
1370	S15C	15	F.1110-C15k ; F.1511-C16k	1
–	–	40G	–	2
–	S25C	25	F.1120-C25k	2
2120	SMn438(H)	35G2 ; 35GL	F.1203-36Mn6 ; F.8212-36Mn5	2
–	SCM1	30G	28Mn6	2
1572	S35C	35	–	2
1672	S45C	45	F.1140-C45k ; F.1142-C48k	2
–	S55C	55	F.1150-C55k	2
1674	S50C	50	–	3
1678	S58C	60 ; 60G ; 60GA	–	3
1870	SUP4	–	–	8
–	SCMnH/1	110G13L	F.8251-AM-X120Mn12	9
2258	SUJ2	SchCh15	F.1310-100Cr6	8
2912	–	–	F.2601-16Mo3	8
–	–	–	F.2602-16Mo5	8
–	–	–	F.2641-15Ni6	4
–	–	–	F.2645-X8Ni09	8
–	–	–	–	8
–	SNC236	–	–	5
–	SNC415(H)	–	F.1540-15NiCr11	5
–	SNC81 5(H)	–	–	5
–	–	40ChN2MA ; 40ChGNM	F.1280-35NiCrMo4	5
2506	SNM220(H)	20ChGNM	F.1552-20NiCrMo2 ; F.1534-20NiMo31	5
–	SNM240	38ChGNM	F.1204-40NiCrMo2 ; F.1205-40NiCrMo2DF	5
2541	–	38Ch2N2MA	F.1272-40NiCrMo7 ; 34CrNiMo6	5
–	–	–	F.1560-14NiCrMo13	5
–	–	–	F.1560-14NiCrMo13 ; F.1569-14NiCrMo131	5
–	SCR415(H)	15Ch	–	2
–	SCR430(H)	35Ch	F.8221-35Cr4	5
–	SCR440(H)	40Ch	F.1211-41Cr4DF ; F.1202-42Cr4	5
2245	SCR440	40Ch	F.1202-42Cr4	5
2511	–	18ChG	F.1516-16MnCr5 ; F.1517-16MnCr5	5
–	SUP9(A)	50ChGA	F.1431-55Cr3	5
2225	SCM420	20ChM ; 30ChM	F.8372-AM26CrMo4;F.8330-AM25CrMo4;F.1256-30CrMo4-1	5
2234	SCM432; SCCRM3	AS38ChGM;35ChM;35ChML	F.8331-AM34CrMo4;F.823134CrMo4;F.1250-35CrMo4;F.1254-35CrMo4DF	5
2244	SCM440	40ChFA	F.8332-AM42CrMo4;F.8232-42CrMo4;F.1252-40CrMo4	5
2244	SCM440(H)	–	F.8332-AM42CrMo4;F.8232-42CrMo4;F.1252-40CrMo4	5
2216	SCM415(H)	–	F.1551-12CrMo4	5
–	–	12ChM ; 15ChM	F.2631-14CrMo45	5
2240	–	–	F.124.A	5
2218	–	12Ch8	TU.H	5
–	–	–	F.2621-13MoCrV6	5
2230	SUP10	50ChGFA ; 50ChFA	F.1430-51CrV4	5
2940	–	38ChMJuA	F.1740-41CrAlMo7	8
–	–	–	–	8
1880	–	U10A-1;2	F.516	5
–	SK2	U13	F.5123 ; C120	5
–	–	Ch	F.5230 ; 100Cr6	8
–	SKD1	Ch12	F.5212 ; X210 Cr12	10
–	–	–	–	10
–	–	–	–	10
–	–	–	–	10
–	SKD6	4ChMFS	F.5317 ; X37 CrMoV5	10
2242	SKD61	4ChMF1S	F.5318 ; X40CrMoC5	10
–	–	–	–	10
2260	SKD12	–	F.5227 ; X100CrMoV5	10
–	–	–	–	10
2310	SKD11	–	F.520A	10
2140	SKS31;SKS2,SKS3	ChWG	F.5233 ; 105WCr5	10
2312	SKD2	–	F.5213 ; X210CrW12	10
2710	–	5ChW2SF	F.5241 ; 45WCrSi8	10
–	SKD5	3Ch2W8F	F.5323 ; X30WCrV9	10
2310	–	–	F.5211 ; X160CrMoV12	10
–	SKT4	5ChNM	F.520S	10
–	–	–	–	10
–	SKS43	–	–	10
2723	SKH55	2723	R6M5K5	10
–	SKH3	–	F.5530 ; 18-1-1-5	10
2722	SKH9	(R6AM5) ; R6M5	F.5603 ; 6-5-2	10
2782	–	–	F.5607 ; 18-0-1	10
–	SKH2	R18	F.5520 ; 18-0-1	10

P

# Material Comparison Table (con't)

Material Group	VarDEX No.	USA AISI/SAE	Germany W.-Nr.	Germany DIN	Great Britain BS	France AFNOR	Italy UNI
<b>M</b> Stainless Steel	12	403	1.4000	X6Cr13	403S17	Z6C13	X6Cr13
	12	-	1.4001	X7Cr14	-	-	-
	12	410	1.4006	X10Cr13	410S21	Z10C14	X12Cr13
	12	430	1.4016	X6Cr17	430S15	Z8C17	X8Cr17
	12	-	1.4027	G-X20Cr14	420C29	Z20C13M	-
	12	-	1.4034	X46Cr13	420S45	Z40CM;Z38C13M	X40Cr14
	12	431	1.4057	X20CrNi172	431S29	Z15CNi6.02	X16CrNi16
	12	430	1.4104	X12CrMoS17	-	Z10CF17	X10CrS17
	12	434	1.4113	X6CrMo171	434S17	Z8CD17.01	X8CrMo17
	12	-	1.4313	X5CrNi134	425C11	Z4CND13.4M	-
	12	-	1.4408	G-X6CrNiMo18 10	316C16	-	-
	12	HW3	1.4718	X45CrSi93	401S45	Z45CS 9	X45CrSi8
	12	405	1.4724	X10CrAl13	403S17	Z10C13	X101CrAl12
	11	-	1.4742	X10CrAl18	430S15	Z12CAS18	X8Cr17
	12	HNV6	1.4747	X80CrNiSi20	443S65	Z80CSN20.02	X80CrSiNi20
	11	446	1.4762	X10CrAl24	-	Z10CAS24	X16Cr26
	13	304	1.4301	X5CrNi18 10	304S15	Z6CN18.09	X5CrNi1810
	13	303	1.4305	X10CrNiSi18 9	303S21	Z10CNF 18.09	X10CrNiSi 18.09
	13	304L	1.4306	X2CrNi19 11	304S12;304C12	Z2CN18.10;Z3CN 19.10	X2CrNi18.11
	13	CF8	1.4308	G-X6CrNi18 9	304C15	Z6CN18.10M	-
	13	301	1.4310	X12CrNi177	301S21	Z12CN 17.07	X1 2CrNi1 707
	13	304LN	1.4311	X2CrNi18 10	304S62	Z2CN18.10	-
	13	316	1.4401	X5CrNiMo17122	316S16	Z6CND17.11	X5CrNiMo17 12
	13	316LN	1.4429	X2CrNiMoNi17133	-	Z2CND17.13	-
	13	316L	1.4435	X2CrNiMo18143	316S12	Z2CND17.13	X2CrNiMo17 13
	13	317L	1.4438	X2CrNiMo17133	317S12	Z2CND19.15	X2CrNiMo18 16
	13	329	1.4460	X8CrNiMo275	-	-	-
	12	321	1.4541	X6CrNiTi18 10	2337	Z6CNT18.10	X6CrNiTi18 11
	12	347	1.4550	X6CrNiNb18 10	347S17	Z6CNNb18.10	X6CrNiNb18 11
	12	316Ti	1.4571	X6CrNiMoTi17122	320S17	Z6NDT1 7.12	X6CrNiMoTi17 12
	12	-	1.4581	G-X5CrNiMoNb18 10	318C17	Z4CNDNb18 12M	XG8CrNiMo18 11
	12	318	1.4583	X10CrNiMoNb18 12	-	Z6CNDNb17 13B	X6CrNiMoNb17 13
	13	309	1.4828	X15CrNiSi20 12	309S24	Z15CNS20.12	-
	13	310S	1.4845	X12CrNi25 21	310S24	Z12CN25 20	X6CrNi25 20
	13	330	1.4864	X12NiCr36 16	-	Z12NCS35.16	-
	13	-	1.4865	G-X40NiCrSi38 18	330C11	-	XG50NiCr39 19
13	EV8	1.4871	X53CrMnNiN2 19	349S54;321S12	Z52CMN21.09	X53CrMnNiN219	
13	321	1.4878	X12CrNiTi18 9	321S320	Z6CNT18.12B	X6CrNiTi1811	
30	No 20 B	0.6010	GG10	-	Ft 10 D	-	
30	No 25 B	0.6015	GG15	Grade 150	Ft 15 D	-	
30	No 30 B	0.6020	GG20	Grade 220	Ft 20 D	-	
29	No 35 B; No 40 B	0.6025	GG25	Grade 260	Ft 25 D	-	
29	No 45 B	0.6030	GG30	Grade 300	R 30 D	-	
29	No 50 B	0.6035	GG35	Grade 350	Ft 35 D	-	
29	No 55 B	0.6040	GG40	Grade 400	Ft 40 D	-	
29	ASTM	-	DIN4694	3468: 1974	-	-	
29	A436-72	-	GGL-	-	A32-301	-	
29	Type 2	-	NiCr20 2	L-NiCr 20 2	L-NC 20 2	-	
30	60-40-18	0.7040	GGG 40	SNG 420/12	FCS 400-12	GS 370-17	
30	-	0.7043	GGG 40.3	SNG 370/17	FGS 370-17	-	
30	-	0.7033	GGG 35.3	-	-	-	
31	80-55-06	0.7050	GGG 50	SNG 500/7	FGS 500-7	GS 500	
31	-	0.7060	GGG 60	SNG 600/3	FGS 600-3	-	
31	100-70-03	0.7070	GGG70	SNG 700/2	FGS 700-2	GS 700-2	
31	-	-	DIN 1694	-	L-NM 13 7	-	
31	Type 2	-	GGG NiMn 13 7	L-NiMn 13 7	L-NC 20 2	-	
31	-	-	GGG NiCr 20 2	L-NC 20 2	-	-	
28	32510	0.8135	GTS-35	B 340/12	MN 35-10	-	
29	40010	0.8145	GTS-45	P 440/7	-	-	
29	50005	0.8155	GTS-55	P 510/4	MP50-5	-	
29	70003	0.8165	GTS-65	P 570/3	MP 60-3	-	
29	80002	0.8170	GTS-70	P690/2	MP 70-2	-	
36	-	-	G-AlSi12	LM20	-	-	
36	-	-	GD-AlSi12	-	-	-	
36	-	-	GD-AlSi8Cu3	LM24	-	-	
36	-	-	G-AlSi10Mg	LM9	-	-	
36	-	-	G-AlSi12	LM6	-	-	
19	330	1.4864	X12NiCrSi	-	Z12NCS35.16	-	
19	-	1.4865	G-X40NiCrSi	330C11	-	XG50NiCr	
19	5390 A	2.4603	-	-	NC22FeD	-	
19	-	2.4630	NiCr20Ti	HR5, 203-4	NC20T	-	
19	5666	2.4856	NiCr22Mo9N	-	NC22FeDNB	-	
19	5537 C	LW2.496	CoCr20W15	-	KC20WN	-	
19	4676	2.4375	NiCu30Al	3072-76	-	-	
19	-	2.4631	NiCr20TiAk	Hr40,601	NC20TA	-	
19	AMS 5399	2.4973	NiCr19Co11	-	NC19KDT	-	
21	5391	LW2.467	S-NiCr13A16	3146-3	NC12AD	-	
21	5660	LW2.466	NiCr19Fe19	HR8	NC19FeNb	-	
21	5383	LW2.466	NiCr19Fe19	-	NC20K14	-	
21	-	-	CoCr22W14	-	KC22WN	-	
21	-	LW2.467	NiCo15Cr10	-	-	-	
23	-	-	TiAl14Mo4Sn4Si0.5	-	-	-	
23	-	-	TiAl5Sn2.5	TA14/17	T-A5E	-	
23	-	-	TiAl6V4	TA10-13/TA2	T-A6V	-	
23	-	-	TiAl6V4ELI	TA11	-	-	

Thread Turning  
Technical Data

Sweden SS	Japan JIS	Russia GOST	Spain UNE	Vardex No.	
2301	SUS403	08Ch13	F.3110-X6Cr13 ; F.8401-AM-X12Cr13	12	<b>M</b>
-	-	08Ch13	F.3110-X6Cr13 ; F.8401-AM-X12Cr13	12	
2302	SUS410	12Ch13 ; 15Ch13L	F.3401-X10Cr13	12	
2320	SUS430	12Ch17	F.3113-X6Cr17	12	
-	SCS2	20Ch13L	-	12	
2304	SUS420J2	40Ch13	F.3405-X45Cr13	12	
2321	SUS431	20Ch17N2	F.3427-X19CrNi172	12	
2383	SUS430F	-	F.3117-X10CrS17 ; F.3413-X14CrMoS17	12	
2325	SUS434	-	F.3116-X6CrMo171	12	
-	SCS5	-	-	12	
-	SCS14	07Ch18N10G2S2M2L	F.8414-AM-X7CrNiMo2010	12	
-	SUH1	40Ch9S2	F.3220-X45CrSi09-03	12	
-	SUS405	10Ch13SJ	F.3152-X10CrAl13	12	
-	SUH21	15Ch18SJ	F.3153-X10CrAl18	11	
-	SUH4	-	F.3222-X80CrSiNi20-02	12	
2322	SUH446	-	F.3154-X10CrAl24	11	
2332	SUS304	08Ch18N10	F.3551-X5CrNi1811;F.3541-X5CrNi1810 ; F.3504-X6CrNi1910	13	
2346	SUS303	-	F.3508-X10CrNiS18-09	13	
2352	SCS19; SUS304L	03Ch18N11	F.3503-X2CrNi1810	13	
2333	SCS13	07Ch18N9L	-	13	
2331	SUS301	-	F.3517-X12CrNi177	13	
2371	SUS304LN	-	F.3541-X2CrNi1810	13	
2347	SUS316	-	F.3534-X5CrNiMo17122	13	
2375	SUS316LN	-	F.3543-X2CrNiMoN17133	13	
2353	SCS16	03Ch17N14M3	F.3533-X2CrNiMo17132	13	
2367	SUS317L	-	F.3539-X2CrNiMo18164	13	
2324	SUS329L;	-	F.3309-X8CrNiMo27-05; F.3552-X8CrNiMo266	13	
58B	SUS321	06Ch18N10T; 08Ch18N10T; 09Ch18N10T; 12Ch18N10T	F.3523-X6CrNiTi1810	12	
2338	SUS347	08Ch18N12B	F.3524-X6CrNiNb1810	12	
2350	-	10Ch17N13M2T	F.3535-X6CrNiMoTi17122	12	
-	SCS22	-	-	12	
-	-	-	-	12	
-	SUH309	20Ch20N14S2	F.3312-X15CrNiSi20-12	13	
2361	SUH310	20Ch23N18	-	13	
-	SUH330	-	F.3313-X12CrNiSi36-16	13	
-	SCH15	-	-	13	
-	SUH35,SUH36,SU321	55Ch20G9AN4	F.3217-X53CrMnNiN21-09	13	
-	-	-	-	13	
01 10	-	C410	FG10	30	
01 15	-	C415	FG15	30	
01 20	-	C420	FG20	30	
01 25	-	C425	FG25	29	
01 30	-	C430	FG30	29	
01 35	-	C435	FG35	29	
01 40	-	C440	-	29	
MB	-	-	-	29	
ISO-215	-	-	-	29	
523	-	-	-	29	
07 17-02	-	VC42-12	-	30	
07 17-12	-	VC42-12	-	30	
07 17-15	-	-	-	30	
07 27-02	-	VC50-2	-	31	
07 32-03	-	VC60-2	-	31	
07 37-01	-	VC70-2	-	31	
07 72	-	-	-	31	
07 76	-	-	-	31	
-	-	-	-	31	
08 15	-	-	-	28	
08 52	-	-	-	29	
08 54	-	-	-	29	
08 58	-	-	-	29	
08 62	-	-	-	29	
4260	-	-	-	36	
4247	-	-	-	36	
4250	-	-	-	36	
4253	-	-	-	36	
4261	-	-	-	36	
-	SUH 330	-	F.3313-X12CrNiSi36-16	19	
-	SCH 15	-	-	19	
-	-	-	-	19	
-	-	-	-	19	
-	-	-	-	19	
-	-	-	-	19	
-	-	-	-	19	
-	-	-	-	19	
-	-	-	-	19	
-	-	-	-	19	
-	-	-	-	19	
-	-	-	-	19	
-	-	-	-	21	
-	-	-	-	21	
-	-	-	-	21	
-	-	-	-	21	
-	-	-	-	21	
-	-	-	-	21	
-	-	-	-	23	
-	-	-	-	23	
-	-	-	-	23	
-	-	-	-	23	

**K**

**N**

**S**

# Troubleshooting

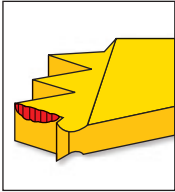
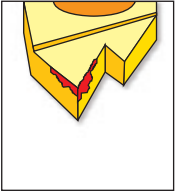
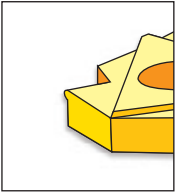
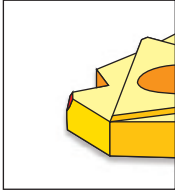
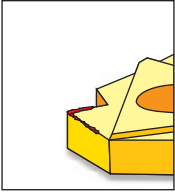
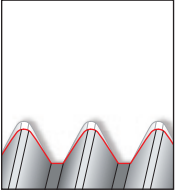
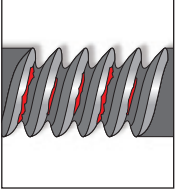
	Problem	Possible Cause	Solution
	Increased flank wear	Cutting speed too high -----> Depth of cut too low/ too many passes -----> Unsuitable carbide grade -----> Insufficient cooling ----->	Reduce cutting speed/ use coated insert Increase the depth of cut per pass Use a coated carbide grade Increase coolant flow rate
	Uneven cutting edge wear	Incorrect helix angle -----> Wrong infeed method ----->	Choose the correct anvil Use the alternating flank infeed method
	Extreme plastic deformation	Depth of cut too large -----> Insufficient cooling -----> Cutting speed too high -----> Unsuitable carbide grade -----> Nose radius too small ----->	Decrease depth of cut/ increase number of passes Increase coolant flow rate Reduce cutting speed Use a tougher carbide Use an insert with a larger radius, if possible
	Cutting edge breakage	Depth of cut too large -----> Extreme plastic deformation -----> Insufficient cooling -----> Unsuitable carbide grade -----> Instability ----->	Decrease depth of cut/ increase number of passes Use a tougher carbide Increase flow rate and/ or correct flow direction Use a tougher carbide Check stability of the system
	Built-up edge	Incorrect cutting speed -----> Unsuitable carbide grade ----->	Change the cutting speed Use a coated carbide
	Thread profile is too shallow	The tool is not at the workpiece axis height ---> Insert is not machining the thread crest -----> Worn insert ----->	Change tool height Measure the workpiece diameter Change the cutting edge sooner
	Poor surface quality	Cutting speed too low -----> Wrong anvil -----> Flank infeed method is not appropriate ----->	Increase cutting speed Choose correct anvil Use the alternate flank or radial infeed method



# Grooving



> Inserts



# GROOVING INSERTS

■ VARDEX Ordering Code System.....	Page 149
■ External - DIN 471 Retaining Ring Grooves for Shafts.....	Page 150
■ Internal - DIN 472 Retaining Ring Grooves for Bores.....	Page 151
■ Internal - DIN 472 Retaining Ring Grooves for Bores-Micro.....	Page 152
■ External/Internal - DIN 7993 Snap Ring Grooves.....	Page 154
■ External/Internal - DIN 7993 Snap Ring Grooves - Micro.....	Page 155
■ External - DIN 76 Thread Undercuts.....	Page 156
■ Internal - DIN 76 Thread Undercuts.....	Page 157
■ Internal - DIN 3770 - Grooves - Micro.....	Page 157
■ Internal - DIN 471 DIN 472 - Face Grooves - Micro.....	Page 158
■ Square Groove - Microscope.....	Page 159
■ Round Groove - Microscope.....	Page 160
■ Face Groove - Microscope.....	Page 161
■ Pre-Part Off - Microscope.....	Page 162

# Vardex Ordering Code System

## Grooving Insert

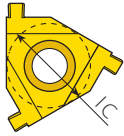
<b>5</b>	<b>L</b>	<b>I</b>	<b>R</b>	<b>1.1</b>	<b>-</b>	<b>D472</b>	<b>-</b>	<b>1.3</b>	<b>VKP</b>
<b>1</b>	<b>2</b>	<b>3</b>	<b>4</b>	<b>5</b>	<b>6</b>	<b>7</b>	<b>6</b>	<b>8</b>	<b>9</b>

<b>1 - Insert Size</b> 5.0L - IC5.0L 2 - IC1/4" 3 - IC3/8" 4 - IC1/2" 5 - IC5/8" 	<b>2 - Insert Style</b> L 	<b>3 - Type of Insert</b> E - External I - Internal	<b>4 - RH / LH Insert</b> R - Right Hand Insert L - Left Hand Insert
--	---	---	--

<b>5 - Groove Std. Width</b> 0.8 - 2.15 (mm)	<b>6 - Profile Style</b> C - Full Profile	<b>7 - Groove Standard</b> DIN 471 Partial DIN 471 DIN 472 Partial DIN 472 DIN 7993 Partial DIN 7993 DIN 76 ST, DIN 76 SH DIN 3770	<b>8 - Groove Depth</b> 0.33 - 2.0 (mm)	<b>9 - Carbide Grade</b> VTX VKP (for Mini) VHX (for Mini)
---	--	--	--	---

## Grooving Micro Insert - Double Ended

<b>4.0</b>	<b>S</b>	<b>I</b>	<b>R</b>	<b>0.7</b>	<b>A</b>	<b>-</b>	<b>D471/D472</b>	<b>-</b>	<b>1.4</b>	<b>VMX</b>
<b>1</b>	<b>2</b>	<b>3</b>	<b>4</b>	<b>5</b>	<b>6</b>		<b>7</b>		<b>8</b>	<b>9</b>

<b>1 - Insert Dia.</b> 3.0 - 3.0 mm 4.0 - 4.0 mm 6.0 - 6.0 mm 8.0 - 8.0 mm 10.0 - 10.0 mm	<b>2 - Insert Style</b> S - Micro Insert	<b>3 - Type of Insert</b> I - Internal	<b>4 - RH / LH Insert</b> R - Right Hand Insert L - Left Hand Insert	<b>5 - Groove std. Width</b> 0.9 - 2.15 (mm)
--	---	---	--	---

<b>6 - Insert Length</b> A - Axialy S - Short M - Medium L - Long	<b>7 - Groove Standard</b> DIN 471 DIN 472 DIN 7993 DIN 76SH, DIN 76ST DIN 3770S, DIN 3770D DIN 471/472 - Face Grooving	<b>8 - Groove Depth</b> 0.5 - 1.5 (mm)	<b>9 - Carbide Grade</b> VMX
---	---	---	---------------------------------

## Grooving microscope Inserts - Single Ended

<b>M</b>	<b>4</b>	<b>42</b>	<b>GS</b>	<b>W</b>	<b>100</b>	<b>L16</b>	<b>R/L</b>	<b>VBX</b>
<b>1</b>	<b>2</b>	<b>3</b>	<b>4</b>	<b>5</b>	<b>6</b>	<b>7</b>	<b>8</b>	<b>9</b>

<b>1 - Product Line</b> M - Microscope	<b>2 - Insert Size</b> 4, 5, 6, 7	<b>3 - Min Bore Dia.</b> 4.2 - 7.2
---	--------------------------------------	---------------------------------------

<b>4 - Type of Application</b> GS - Grooving Square GR - Grooving Round FG - Face Grooving Internal FP - Face Grooving External PP - Pre Part Off	<b>5-6 - Width / Radius</b> <table border="1"> <tr> <th>Width</th> <th>Radius</th> </tr> <tr> <td>1.0-3.0 (mm)</td> <td>0.5-1.0 (mm)</td> </tr> </table>	Width	Radius	1.0-3.0 (mm)	0.5-1.0 (mm)	<b>7 - Overhang Length</b> L10 - L35	<b>8 - LH or RH</b> R - RH L - LH	<b>9 - Carbide Grades</b> VBX
Width	Radius							
1.0-3.0 (mm)	0.5-1.0 (mm)							

# DIN 471 Retaining Ring Grooves for Shafts

## External

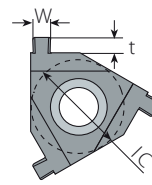
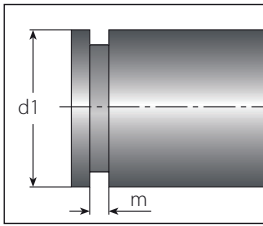

Standard  
(Partial Profile)

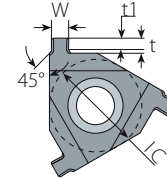

Standard  
(Full Profile)

### Standard (Partial Profile)



Insert Size	Ordering Code	Groove Std.	Dimensions mm			Anvil	Holder
IC	RH	m (H13)	W	t			
3/8"	3ER1.10-D471-1.30...	1.10	1.19	1.3		YE3M-1.5N	AL...-3
	3ER1.30-D471-1.50...	1.30	1.39	1.5			
	3ER1.60-D471-1.85...	1.60	1.69	1.8			
	3ER1.85-D471-2.00...	1.85	1.94	2.0			

Range of profiles also available on IC 1/4", 1/2" and 5/8", inserts on request.

### Standard (Full Profile)



Insert Size	Ordering Code	Groove Std.	Dimensions mm				Anvil	Holder
IC	RH	m(H13)	d1	W	t1	t		
3/8"	3ER1.10C-D471-0.35...	1.10	15	1.19	0.33	0.35	YE3M-1.5N	AL...-3
	3ER1.10C-D471-0.40...	1.10	16-17	1.19	0.36	0.40		
	3ER1.30C-D471-0.50...	1.30	18-22	1.39	0.44	0.50		
	3ER1.30C-D471-0.55...	1.30	24-26	1.39	0.45	0.55		
	3ER1.60C-D471-0.70...	1.60	28-30	1.69	0.60	0.70		
	3ER1.60C-D471-0.85...	1.60	32-34	1.69	0.75	0.85		
	3ER1.60C-D471-1.00...	1.60	35	1.69	0.85	1.00		
	3ER1.85C-D471-1.00...	1.85	36-38	1.94	0.85	1.00		
	3ER1.85C-D471-1.25...	1.85	40-48	1.94	1.10	1.25		
	3ER2.15C-D471-1.50...	2.15	50-63	2.24	1.35	1.50		

Range of profiles also available on IC 1/4", 1/2" and 5/8", inserts on request.



# DIN 472 Retaining Ring Grooves for Bores

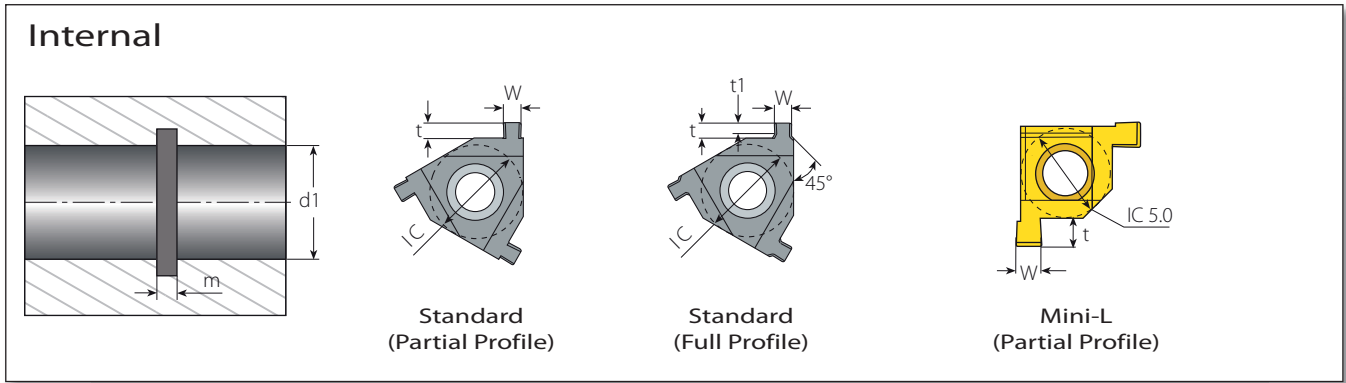

## Standard (Partial Profile)



Insert Size	Ordering Code	Groove Std.	Dimensions mm		Anvil	Holder
IC		m (H13)	W	t		
3/8"	3IR1.10-D472-1.30...	1.10	1.19	1.30	Y13M-1.5N	AVR...-3
	3IR1.30-D472-1.50...	1.30	1.39	1.50		
	3IR1.60-D472-1.80...	1.60	1.69	1.80		
	3IR1.85-D472-2.00...	1.85	1.94	2.00		

Range of profiles also available on IC 1/4", 1/2" and 5/8", inserts on request.  
For minimum bore diameters, refer to page 165.

## Standard (Full Profile)



Insert Size	Ordering Code	Groove Std.	Dimensions mm			Anvil	Holder
IC		m (H13)	d1	W	t1	t	
3/8"	3IR1.10C-D472-0.50...	1.10	18-22	1.19	0.36	0.50	Y13M-1.5N AVR...-3
	3IR1.30C-D472-0.60...	1.30	24-26	1.39	0.44	0.60	
	3IR1.30C-D472-0.70...	1.30	28-30	1.39	0.60	0.70	
	3IR1.30C-D472-0.85...	1.30	31-34	1.39	0.75	0.85	
	3IR1.60C-D472-0.85...	1.60	34	1.69	0.75	0.85	
	3IR1.60C-D472-1.00...	1.60	35-38	1.69	0.85	1.00	
	3IR1.85C-D472-1.25...	1.85	40-48	1.94	1.10	1.25	
	3IR2.15C-D472-1.50...	2.15	50-63	2.24	1.35	1.50	

Range of profiles also available on IC 1/4", 1/2" and 5/8", inserts on request.  
For minimum bore diameters, refer to page 165.

## Mini-L (Partial Profile)



Insert Size	Ordering Code	Groove Std.	Dimensions mm		Min. Bore dia (mm)	Holder
IC		m (H13)	W	t		
5.0L	5LIR0.9-D472-0.7...	0.9	0.99	0.7	8.0	.NVR10..-5L
	5LIR1.1-D472-1.0...	1.1	1.19	1.0		
	5LIR1.3-D472-1.5...	1.3	1.39	1.5		

# DIN 472 Retaining Ring Grooves for Bores



## Internal

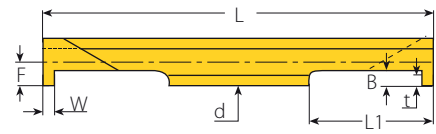
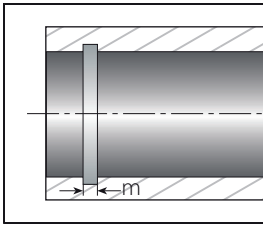

RH-Double Ended

## Micro - Double Ended

Insert dia.	Ordering Code	Groove Std.	Dimensions mm						Min. Bore dia.	Holder
d (mm)	RH	m (H13)	W	L1	L	B	t	F	mm	
3.0	3.0SIR0.90S-D472-0.5...	0.90	0.99	9.0	36.0	0.8	0.5	1.40	3.2	SMC..-3.0
	3.0SIR0.90M-D472-0.5...	0.90	0.99	16.0	50.0					
	3.0SIR1.10S-D472-0.5...	1.10	1.19	9.0	36.0					
	3.0SIR1.10M-D472-0.5...	1.10	1.19	16.0	50.0					
4.0	4.0SIR0.90S-D472-1.1...	0.90	0.99	9.0	36.0	1.4	1.1	1.90	4.1	SMC..-4.0
	4.0SIR0.90M-D472-1.1...	0.90	0.99	16.0	50.0					
	4.0SIR0.90L-D472-1.1...	0.90	0.99	21.0	60.0					
	4.0SIR1.10S-D472-1.1...	1.10	1.19	9.0	36.0					
	4.0SIR1.10M-D472-1.1...	1.10	1.19	16.0	50.0					
	4.0SIR1.10L-D472-1.1...	1.10	1.19	21.0	60.0					
	4.0SIR1.30S-D472-1.1...	1.30	1.39	9.0	36.0					
	4.0SIR1.30M-D472-1.1...	1.30	1.39	16.0	50.0					
	4.0SIR1.30L-D472-1.1...	1.30	1.39	21.0	60.0					
	4.0SIR1.60S-D472-1.1...	1.60	1.69	9.0	36.0					
	4.0SIR1.60M-D472-1.1...	1.60	1.69	16.0	50.0					
	4.0SIR1.60L-D472-1.1...	1.60	1.69	21.0	60.0					
6.0	6.0SIR0.90S-D472-1.5...	0.90	0.99	9.0	36.0	1.8	1.5	2.90	6.1	SMC..-6.0
	6.0SIR0.90M-D472-1.5...	0.90	0.99	16.0	50.0					
	6.0SIR0.90L-D472-1.5...	0.90	0.99	21.0	60.0					
	6.0SIR1.10S-D472-1.5...	1.10	1.19	9.0	36.0					
	6.0SIR1.10M-D472-1.5...	1.10	1.19	16.0	50.0					
	6.0SIR1.10L-D472-1.5...	1.10	1.19	21.0	60.0					
	6.0SIR1.30S-D472-1.5...	1.30	1.39	9.0	36.0					
	6.0SIR1.30M-D472-1.5...	1.30	1.39	16.0	50.0					
	6.0SIR1.30L-D472-1.5...	1.30	1.39	21.0	60.0					
	6.0SIR1.60S-D472-1.5...	1.60	1.69	9.0	36.0					
	6.0SIR1.60M-D472-1.5...	1.60	1.69	16.0	50.0					
	6.0SIR1.60L-D472-1.5...	1.60	1.69	21.0	60.0					
	6.0SIR1.85S-D472-1.5...	1.85	1.94	9.0	36.0					
	6.0SIR1.85M-D472-1.5...	1.85	1.94	16.0	50.0					
	6.0SIR1.85L-D472-1.5...	1.85	1.94	21.0	60.0					
	6.0SIR2.15S-D472-1.5...	2.15	2.24	9.0	36.0					
	6.0SIR2.15M-D472-1.5...	2.15	2.24	16.0	50.0					
	6.0SIR2.15L-D472-1.5...	2.15	2.24	21.0	60.0					

continued on next page ▶

# DIN 472 Retaining Ring Grooves for Bores (con't)



## Internal

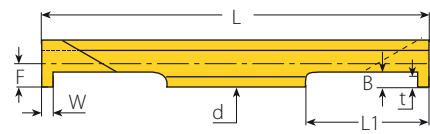
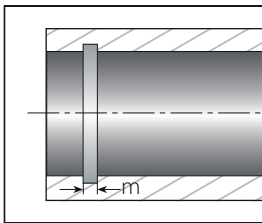

RH-Double Ended

## Micro - Double Ended (con't)

Insert dia.	Ordering Code	Groove Std.	Dimensions mm					Min. Bore dia.	Holder	
d (mm)	RH	m (H13)	W	L1	L	B	t	F	mm	
8.0	8.0SIR1.10M-D472-2.0...	1.10	1.19	20	70	2.5	2.0	3.9	8.4	SMC.-8.0
	8.0SIR1.30M-D472-2.0...	1.30	1.39	20	70	2.5	2.0			
	8.0SIR1.60M-D472-2.5...	1.60	1.69	20	70	3.0	2.5			
	8.0SIR1.85M-D472-2.5...	1.85	1.94	20	70	3.0	2.5			
	8.0SIR2.15M-D472-3.0...	2.15	2.24	20	70	3.5	3.0			
	8.0SIR2.65M-D472-3.5...	2.65	2.74	20	70	4.0	3.5			
	8.0SIR3.15M-D472-3.5...	3.15	3.28	20	70	4.0	3.5			
10.0	10.0SIR1.30M-D472-3.5...	1.30	1.39	25	80	4.0	3.5	4.9	10.4	SMC.-10.0
	10.0SIR1.60M-D472-3.5...	1.60	1.69	25	80					
	10.0SIR1.85M-D472-3.5...	1.85	1.94	25	80					
	10.0SIR2.15M-D472-3.5...	2.15	2.24	25	80					
	10.0SIR2.65M-D472-3.5...	2.65	2.74	25	80					
	10.0SIR3.15M-D472-3.5...	3.15	3.28	25	80					
	10.0SIR4.15M-D472-3.5...	4.15	4.28	25	80					
10.0SIR5.15M-D472-3.5...	5.15	5.28	25	80						

# DIN 7993 Snap Ring Grooves

## External

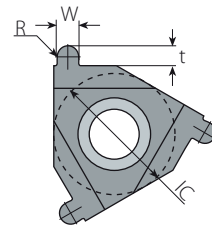
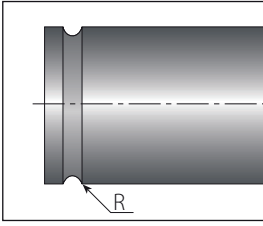

Standard  
(Partial Profile)

## Standard (Partial Profile for Shafts)



Insert Size	Ordering Code	Dimensions mm			Anvil	Holder
IC	RH	R	W	t		
3/8"	3ER0.40-D7993-0.60...	0.40	0.80	0.60	YE3M-1.5N	AL..-3
	3ER0.60-D7993-0.80...	0.60	1.20	0.80		
	3ER0.90-D7993-1.10...	0.90	1.80	1.10		
	3ER1.00-D7993-1.20...	1.00	2.00	1.20		

Range of profiles also available on IC 1/4", 1/2" and 5/8", inserts on request.

## Internal

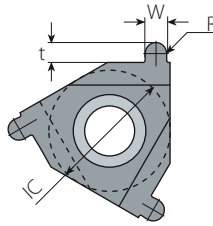
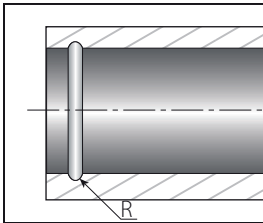

Standard  
(Partial Profile)

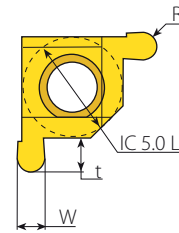

Mini-L  
(Partial Profile)

## Standard (Partial Profile for Bores)



Insert Size	Ordering Code	Dimensions mm			Anvil	Holder
IC	RH	R	W	t		
3/8"	3IR0.60-D7993-0.80...	0.60	1.20	0.80	YI3M-1.5N	AVR..-3
	3IR0.90-D7993-1.10...	0.90	1.80	1.10		
	3IR1.00-D7993-1.20...	1.00	2.00	1.20		

Range of profiles also available on IC 1/4", 1/2" and 5/8" inserts on request.  
For minimum bore diameters, refer to page 165.

## Mini-L (Partial Profile for Bores)



Insert Size	Ordering Code	Dimensions mm			Min Bore dia.	Holder
IC	RH	R	W	t	mm	
5.0L	5LIR0.4-D7993-0.8...	0.4	0.8	0.8	.NVR10-.5L	8.0
	5LIR0.6-D7993-1.0...	0.6	1.2	1.0		

# DIN 7993 Snap Ring Grooves



## Internal

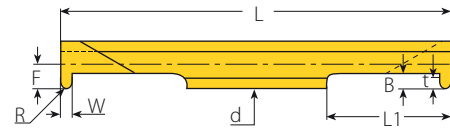
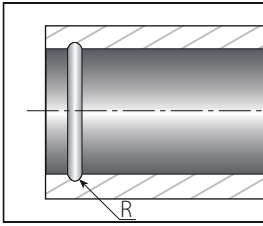

RH-Double Ended

## Micro (Partial Profile) - Double Ended

Insert Dia. d (mm)	Ordering Code	Groove Std.		Dimensions mm						Min. Bore dia. mm	Holder
		RH	R	W	L1	L	B	t	F		
3.0	3.0SIR0.4S-D7993-0.6...		0.40	0.80	9.0	36.0	0.8	0.6	1.40	3.2	SMC...-3.0
	3.0SIR0.4M-D7993-0.6...		0.40	0.80	16.0	50.0					
4.0	4.0SIR0.4S-D7993-0.6...		0.40	0.80	9.0	36.0	0.9	0.6	1.90	4.1	SMC...-4.0
	4.0SIR0.4M-D7993-0.6...		0.40	0.80	16.0	50.0					
	4.0SIR0.4L-D7993-0.8...		0.40	0.80	21.0	60.0	1.1	0.8			
	4.0SIR0.6S-D7993-0.8...		0.60	1.20	9.0	36.0					
	4.0SIR0.6M-D7993-0.8...		0.60	1.20	16.0	50.0	1.4	1.1			
	4.0SIR0.6L-D7993-0.8...		0.60	1.20	21.0	60.0					
	4.0SIR0.9S-D7993-1.1...		0.90	1.80	9.0	36.0	1.4	1.1			
	4.0SIR0.9M-D7993-1.1...		0.90	1.80	16.0	50.0					
6.0	4.0SIR0.9L-D7993-1.1...		0.90	1.80	21.0	60.0	1.4	1.1	2.90	6.1	SMC...-6.0
	6.0SIR0.9S-D7993-1.1...		0.90	1.80	9.0	36.0					
	6.0SIR0.9M-D7993-1.1...		0.90	1.80	16.0	50.0	1.5	1.2			
	6.0SIR0.9L-D7993-1.1...		0.90	1.80	21.0	60.0					
	6.0SIR1.0S-D7993-1.2...		1.00	2.00	9.0	36.0	1.6	1.3			
	6.0SIR1.0M-D7993-1.2...		1.00	2.00	16.0	50.0					
	6.0SIR1.0L-D7993-1.2...		1.00	2.00	21.0	60.0	1.6	1.3			
	6.0SIR1.1S-D7993-1.3...		1.10	2.20	9.0	36.0					
8.0	6.0SIR1.1M-D7993-1.3...		1.10	2.20	16.0	50.0	2.5	2.0	3.90	8.4	SMC...-8.0
	6.0SIR1.1L-D7993-1.3...		1.10	2.20	21.0	60.0					
	8.0SIR0.9M-D7993-2.0...		0.90	1.80	20.0	70.0	3.4	2.9			
8.0SIR1.1M-D7993-2.0...		1.10	2.20	20.0	70.0						
10.0	8.0SIR1.4M-D7993-2.0...		1.40	2.80	20.0	70.0	3.4	2.9	4.90	10.4	SMC...-10.0
	10.0SIR1.4M-D7993-2.9...		1.40	2.80	25.0	80.0					
	10.0SIR1.8M-D7993-2.9...		1.80	3.60	25.0	80.0					

# DIN 76 Thread Undercuts

(For ISO Metric Threads in Accordance with DIN 13)

## External

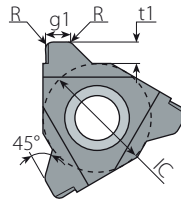
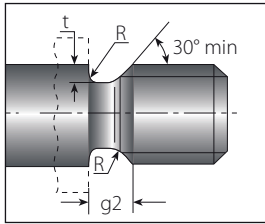

Normal - Type A

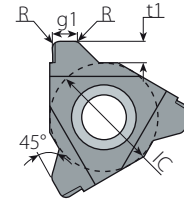

Short - Type B

## Standard (Normal - Type A)

Insert Size	Ordering Code	Pitch	Dimensions mm					Anvil	Holder
IC	RH	mm	R	g1	g2	t	t1		
3/8"	3ER0.50-D76ST-0.40...	0.50	0.2	1.10	1.50	0.40	2.50	YE3M-1.5N	AL..-3
	3ER0.60-D76ST-0.50...	0.60	0.4	1.30	1.80	0.50	2.40		
	3ER0.70-D76ST-0.55...	0.70	0.4	1.55	2.10	0.55	2.20		
	3ER0.80-D76ST-0.65...	0.80	0.4	1.75	2.40	0.65	2.10		
	3ER1.00-D76ST-0.80...	1.00	0.6	2.20	3.00	0.80	1.90		
5/8"	5ER1.25-D76ST-1.00...	1.25	0.6	2.80	3.80	1.00	3.60	YE5M-1.5N	AL..-5
	5ER1.50-D76ST-1.15...	1.50	0.8	3.35	4.50	1.15	3.30		
	5ER1.75-D76ST-1.30...	1.75	1.0	4.00	5.30	1.30	3.00		
	5ER2.00-D76ST-1.50...	2.00	1.0	4.50	6.00	1.50	2.70		



## Standard (Short - Type B)

Insert Size	Ordering Code	Pitch	Dimensions mm					Anvil	Holder
IC	RH	mm	R	g1	g2	t	t1		
3/8"	3ER1.00-D76SH-0.80...	1.00	0.6	1.20	2.00	0.80	2.50	YE3M-1.5N	AL..-3
	3ER1.25-D76SH-1.00...	1.25	0.6	1.50	2.50	1.00	2.30		
	3ER1.50-D76SH-1.15...	1.50	0.8	1.85	3.00	1.15	2.10		
	3ER1.75-D76SH-1.30...	1.75	1.0	2.20	3.50	1.30	1.90		
5/8"	5ER2.00-D76SH-1.50...	2.00	1.0	2.50	4.00	1.50	3.80	YE5M-1.5N	AL..-5
	5ER2.50-D76SH-1.80...	2.50	1.2	3.20	5.00	1.80	3.50		
	5ER3.00-D76SH-2.20...	3.00	1.6	3.80	6.00	2.20	3.10		



Range of profiles also available on IC 1/4" and 1/2" inserts on request.

# DIN 76 Thread Undercuts

(For ISO Metric Threads in Accordance with DIN 13)

## Internal

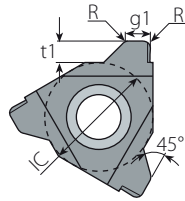
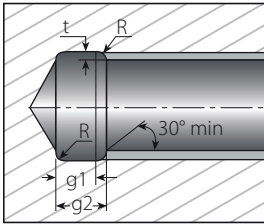

Normal - Type C

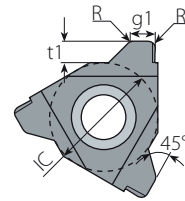

Short - Type D

## Standard (Normal - Type C)



Insert Size	Ordering Code	Pitch	Dimensions mm					Anvil	Holder
IC	RH	mm	R	g1	g2	t	t1		
3/8"	3IR0.50-D76ST-0.40...	0.50	0.2	1.10	1.50	0.40	2.50	Y13M-1.5N	AL...3
	3IR0.60-D76ST-0.50...	0.60	0.4	1.30	1.80	0.50	2.40		
	3IR0.70-D76ST-0.55...	0.70	0.4	1.55	2.10	0.55	2.20		
	3IR0.80-D76ST-0.65...	0.80	0.4	1.75	2.40	0.65	2.10		
	3IR1.00-D76ST-0.80...	1.00	0.6	2.20	3.00	0.80	1.90		

Range of profiles also available on IC 1/4", 1/2" and 5/8" inserts on request.  
For minimum bore diameters, refer to page 165.

## Standard (Short - Type D)



Insert Size	Ordering Code	Pitch	Dimensions mm					Anvil	Holder
IC	RH	mm	R	g1	g2	t	t1		
3/8"	3IR1.00-D76SH-0.80...	1.00	0.6	1.20	2.00	0.80	2.50	Y13M-1.5N	AL...3
	3IR1.25-D76SH-1.00...	1.25	0.6	1.50	2.50	1.00	2.30		
	3IR1.50-D76SH-1.15...	1.50	0.8	1.85	3.00	1.15	2.10		
	3IR1.75-D76SH-1.30...	1.75	1.0	2.20	3.50	1.30	1.90		

Range of profiles also available on IC 1/4", 1/2" and 5/8" inserts on request.  
For minimum bore diameters, refer to page 165.

## DIN 3770 - Grooves



### Internal

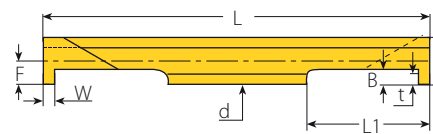
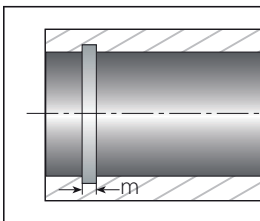

RH-Double Ended

### Micro - Double Ended

Insert dia.	Ordering Code	Groove Std.		Dimensions mm					Min. Bore dia.	Holder
d (mm)	RH	m (H13)	W	L1	L	B	t	F	mm	
6.0	6.0SIR1.6S-D3770S-1.5...	1.6	1.98	9.0	36.0	1.8	1.5	2.9	6.1	SMC...-6.0
	6.0SIR1.6M-D3770S-1.5...	1.6	1.98	16.0	50.0					
	6.0SIR1.6L-D3770S-1.5...	1.6	1.98	21.0	60.0					
	6.0SIR2.0S-D3770D-1.8...	2.0	2.38	9.0	36.0	2.0	1.8	2.9		
	6.0SIR2.0M-D3770D-1.8...	2.0	2.38	16.0	50.0					
	6.0SIR2.0L-D3770D-1.8...	2.0	2.38	21.0	60.0					

# DIN 471 DIN 472 - Face Grooves



## Internal

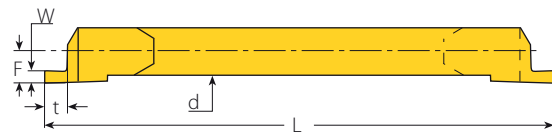
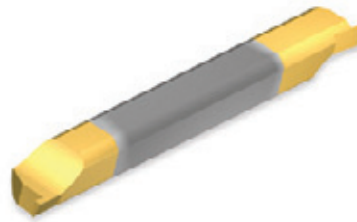
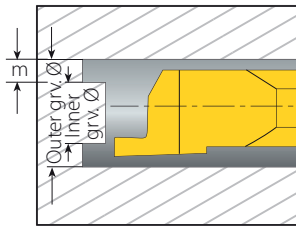

RH-Double Ended

## Micro (Partial Profile) - Double Ended

Insert dia. d (mm)	Ordering Code RH	Groove Std.		Dimensions mm				Inner Groove Ø	Outer Groove Ø
		m (H13)	W	t	L	F	Sleeve		
4.0	4.0SIR0.7A-D471/472-1.4...	0.70	0.77	1.4	50	1.40	SMC...-4.0	3.50	5.00
	4.0SIR0.8A-D471/472-1.5...	0.80	0.87	1.5				3.40	5.20
	4.0SIR0.9A-D471/472-1.6...	0.90	0.97	1.6				3.30	5.30
	4.0SIR1.1A-D471/472-1.8...	1.10	1.19	1.8				3.10	5.50
	4.0SIR1.3A-D471/472-2.0...	1.30	1.39	2.0				2.90	5.70
	4.0SIR1.6A-D471/472-2.3...	1.60	1.69	2.3				2.60	6.00
6.0	6.0SIR0.7A-D471/472-1.4...	0.70	0.77	1.4	50	1.90	SMC...-6.0	5.50	7.00
	6.0SIR0.8A-D471/472-1.5...	0.80	0.87	1.5				5.40	7.20
	6.0SIR0.9A-D471/472-1.6...	0.90	0.97	1.6				5.30	7.30
	6.0SIR1.1A-D471/472-1.8...	1.10	1.19	1.8				5.10	7.50
	6.0SIR1.3A-D471/472-2.0...	1.30	1.39	2.0				4.90	7.70
	6.0SIR1.6A-D471/472-2.3...	1.60	1.69	2.3				4.60	8.00
	6.0SIR1.85A-D471/472-2.5...	1.85	1.94	2.5				4.40	8.20
	6.0SIR2.15A-D471/472-2.8...	2.15	2.24	2.8				4.10	8.50
8.0	8.0SIR1.1A-D471/472-1.8...	1.10	1.19	1.8	70	3.95	SMC...-8.0	8.06	10.44
	8.0SIR1.3A-D471/472-2.0...	1.30	1.39	2.0				7.66	10.44
	8.0SIR1.6A-D471/472-2.3...	1.60	1.69	2.3				7.06	10.44
	8.0SIR1.85A-D471/472-2.5...	1.85	1.94	2.5				6.56	10.44
	8.0SIR2.15A-D471/472-2.8...	2.15	2.24	2.8				5.96	10.44
	8.0SIR2.65A-D471/472-3.3...	2.65	2.74	3.3				4.96	10.44
10.0	10.0SIR1.3A-D471/472-2.0...	1.30	1.39	2.0	80	4.95	SMC...-10.0	9.66	12.44
	10.0SIR1.6A-D471/472-2.3...	1.60	1.69	2.3				9.06	12.44
	10.0SIR1.85A-D471/472-2.5...	1.85	1.94	2.5				8.56	12.44
	10.0SIR2.15A-D471/472-2.8...	2.15	2.24	2.8				7.96	12.44
	10.0SIR2.65A-D471/472-3.3...	2.65	2.74	3.3				6.96	12.44
	10.0SIR3.15A-D471/472-3.8...	3.15	3.24	3.8				5.96	12.44
	10.0SIR4.15A-D471/472-4.8...	4.15	4.24	4.8				3.96	12.44



# Square Groove



## Internal

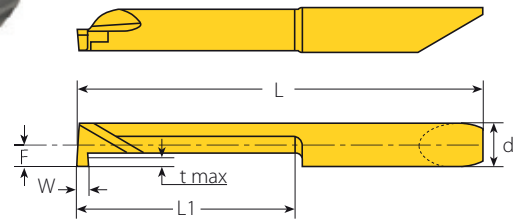
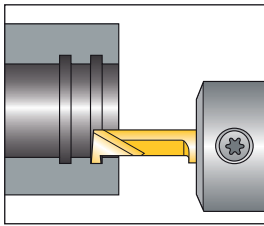

RH-Single Ended

## Micro - Single Ended



Groove Dimensions (mm)		Insert dia.	Ordering Code	Dimensions mm			Min. Bore dia.		
W± 0.025	t max	d(mm)	RH /LH	L1	L	F	mm	Holder	
1.0	0.8	4.0	M442GS W100 L10R/L	10	35	2.0	4.2	MHC...-4	
			M442GS W100 L15R/L	15	41				
			M442GS W100 L20R/L	20	46				
1.0	1.0	5.0	M552GS W100 L10R/L	10	35	2.5	5.2	MHC...-5	
			M552GS W100 L15R/L	15	41				
			M552GS W100 L20R/L	20	46				
M552GS W150 L10R/L			10	35					
M552GS W150 L15R/L			15	41					
M552GS W150 L20R/L			20	46					
1.5	2.0	5.0	M552GS W200 L10R/L	10	35	3.0	6.2	MHC...-6	
2.0			M552GS W200 L15R/L	15	41				
			M552GS W200 L20R/L	20	46				
	1.0	1.8	6.0	M662GS W100 L10R/L	10	36	3.0	6.2	MHC...-6
M662GS W100 L15R/L				15	42				
M662GS W100 L20R/L				20	47				
M662GS W100 L30R/L	30			56					
1.5	M662GS W150 L10R/L			10	36				
				M662GS W150 L15R/L	15	42			
		M662GS W150 L20R/L	20	47					
2.0	M662GS W150 L30R/L	30	56						
		M662GS W200 L10R/L	10	36					
		M662GS W200 L15R/L	15	42					
2.0	M662GS W200 L20R/L	20	47						
		M662GS W200 L30R/L	30	56					
			1.0	2.5	7.0	M772GS W100 L10R/L	10	36	3.5
M772GS W100 L15R/L	15					41			
M772GS W100 L25R/L	25	51							
M772GS W100 L35R/L	35	61							
1.5	M772GS W150 L10R/L	10	36						
		M772GS W150 L15R/L	15			41			
		M772GS W150 L25R/L	25	51					
2.0	M772GS W150 L35R/L	35	61						
		M772GS W200 L10R/L	10	36					
		M772GS W200 L15R/L	15	41					
2.0	M772GS W200 L25R/L	25	51						
		M772GS W200 L35R/L	35	61					

Microscope Left-Handed tools available upon request (Example: M442GS W100L10L...)

Grooving Inserts

# Round Groove



## Internal

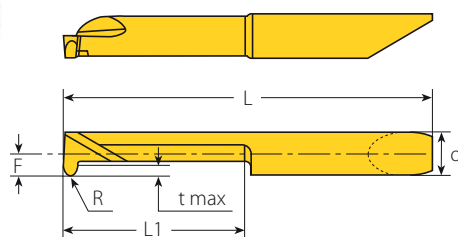
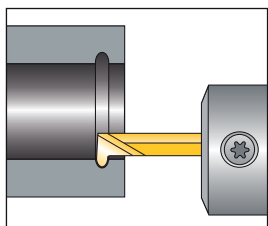

RH-Single Ended

## Micro - Single Ended



Groove Dimensions (mm)		Insert dia.	Ordering Code	Dimensions (mm)				Min. Bore dia.	Holder
W±0.025	t max	d(mm)	RH /LH	R	L1	L	F	mm	
1.0	0.8	4.0	M442GR R050 L15R/L	0.5	15	39	1.95	4.2	MHC ..-4
1.0	1.0	6.0	M552GR R050 L20R/L	0.5	20	46	2.45	5.2	MHC ..-5
1.5			M552GR R075 L20R/L	0.75		46			
2.0			M552GR R100 L20R/L	1.0		46			
1.0	1.8	5.0	M662GR R050 L25R/L	0.5	25	52	2.95	6.2	MHC ..-6
1.5			M662GR R075 L25R/L	0.75		52			
2.0			M662GR R100 L25R/L	1.0		52			

Microscope Left-Handed tools available upon request (Example: M442GR R050L15L...)

# Face Grooving Internal



RH-Single Ended

## Micro - Single Ended



Groove Dimensions (mm)		Insert dia.	Ordering Code	Dimensions mm				Min. Bore dia.	Holder
W±0.025	t max	d(mm)	RH /LH	R	L1	L	F	mm	
1.0	2	6.0	M662FG W10 L15R/L	0.1	15	42	2.95	6.2	MHC ..-6
1.5	3		M662FG W15 L15R/L						
2.0	4		M662FG W20 L15R/L						
2.5	5		M662FG W25 L15R/L						
3.0	6		M662FG W30 L15R/L						

Grooving Inserts

# Face Grooving External



RH-Single Ended

## Micro - Single Ended



Groove Dimensions (mm)		Insert dia.	Ordering Code	Dimensions mm				Min. Bore dia.	Holder
W±0.025	t max	d(mm)	RH /LH	R	L1	L	F	mm	
1.0	2	6.0	M662FP W10 L15R/L	0.1	15	42	2.95	6.2	MHC ..-6
1.5	3		M662FP W15 L15R/L						
2.0	4		M662FP W20 L15R/L						
2.5	5		M662FP W25 L15R/L						
3.0	6		M662FP W30 L15R/L						

# Pre-Part Off



## Micro - Single Ended

microscope

Groove Dimensions (mm)		Insert dia.	Ordering Code	Dimensions (mm)				Min. Bore dia.	Holder
$W \pm 0.025$	t max	d(mm)	RH /LH	t	L1	L	F	mm	
1.0	0.7	5.0	M552PP W100 L15R/L	0.3	15	41	2.45	5.2	MHC...-5
			M552PP W100 L20R/L		20	46			
			M552PP W100 L25R/L		25	51			
			M552PP W100 L30R/L		30	55			

Microscope Left-Handed tools available upon request (Example: M662FP W10 L15L...)



# Grooving



> Toolholders

# GROOVING TOOLHOLDERS



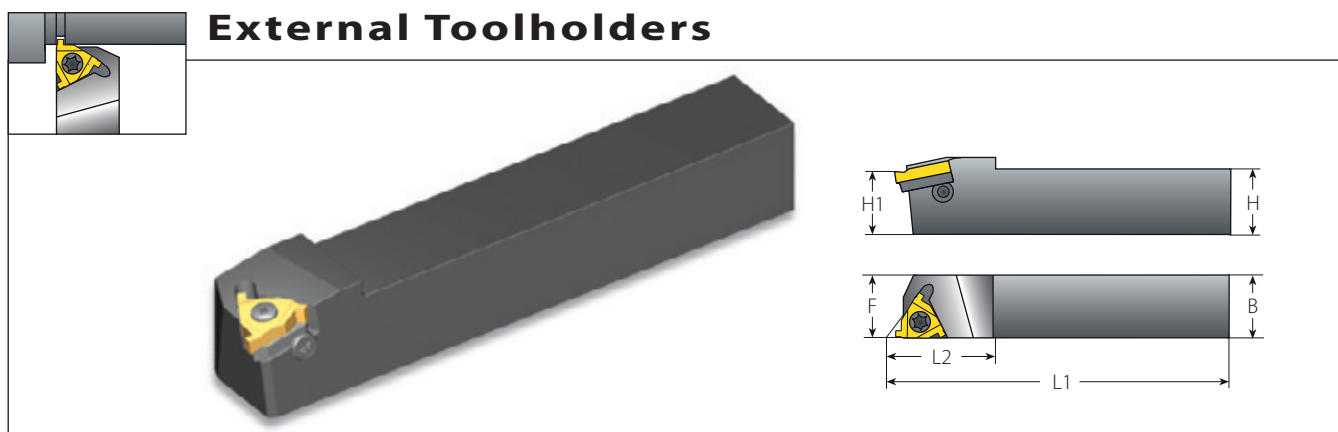

- External Standard.....Page 164
- Internal Standard.....Page 165
- Internal Mini-L.....Page 166
- Internal Mini-L - Adjustable.....Page 166
- Micro.....Page 167
- Microscope.....Page 168

For VARDEX ordering code system, see page 99.



## External Toolholders

### Standard

Standard						Spare Parts			
Insert Size	Ordering Code	Dimensions mm							 *
IC	RH	H=H1=B	F	L1	L2	Insert Screw	Anvil Screw	Torx Key	Anvil RH
1/4"	NL8-2	8	11	136.4	17.5	SN2T	-	K2T	-
	NL10-2	10	11	70.0	17.5				
	NL12-2	12	12	80.0	17.5				
3/8"	AL3/8-3	9.52	16	63.6	20.5	SA3T	SY3T	K3T	YE3M-1.5N
	AL12-3	12	16	100.0	22.0				
	AL16-3	16	16	82.3	20.5				
	AL20-3	20	20	128.6	30.0				
	AL25-3	25	25	153.6	30.0				
1/2"	AL32-3	32	32	173.6	30.0	SA4T	SY4T	K4T	YE4M-1.5N
	AL25-4	25	25	155.7	36.0				
	AL32-4	32	32	175.7	36.0				
5/8"	AL40-4	40	40	205.7	36.0	SA5T	SY5T	K5T	YE5M-1.5N
	AL25-5	25	32	151.6	35.0				
	AL32-5	32	32	176.6	40.0				
	AL40-5	40	40	206.6	40.0				
	AL50-5	50	50	256.6	40.0				

\* The toolholders are supplied with standard anvils. For Grooving, please use the anvils indicated in the table above.

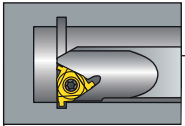

# Internal Toolholders

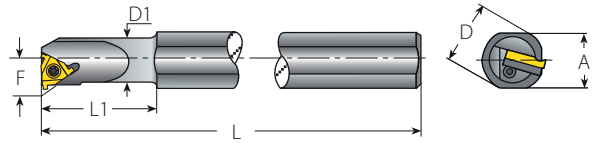
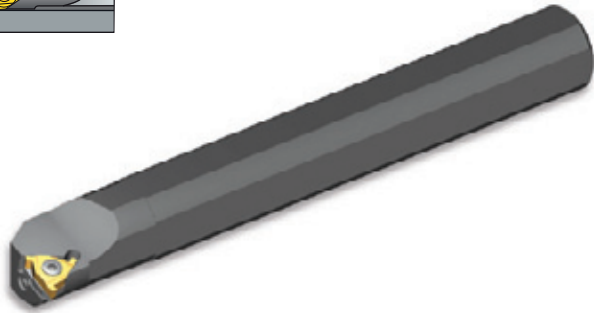

## Standard

## Spare Parts

Insert Size	Ordering Code	Dimensions mm						Min Bore dia.						
		IC	RH	A	L	L1	D		D1	F	mm	Insert Screw	Anvil Screw	Torx Key
1/4"	NVR10D-2			100			10	10.0	7.3	13				
	NVR10-2			18.0	180	25	20	10.0	7.3	13	SN2T	-	K2T	-
	NVR13-2			18.0	180	32	20	13.0	8.9	16				
3/8"	NVR13-3			18.0	180	32	20	12.7	10.3	17				
	NVR16-3			18.0	180	40	20	16.0	11.5	20	SN3T	-	K3T	-
	NVR16D-3			15.2	150	32	16	16.0	11.3	20				
	AVR20-3			18.0	180	40	20	20.0	13.4	24				
	AVR25-3			29.0	250	60	32	25.0	16.3	29				
	AVR25D-3			22.6	200	45	25	24.6	16.1	29	SA3T	SY3T	K3T	YI3M-1.5N
	AVR32-3			29.0	250	60	32	32.0	19.6	36				
1/2"	AVR40-3			36.0	300	60	40	40.0	23.8	44				
	NVR20-4			18.0	180	50	20	20.0	15.6	27	SN4T	-	K4T	-
	AVR25-4			29.0	250	60	32	25.0	17.4	32				
	AVR25D-4			22.6	200	45	25	24.6	17.2	32	SA4T	SY4T	K4T	YI4M-1.5N
	AVR32-4			29.0	250	60	32	32.0	21.5	39				
5/8"	AVR40-4			36.0	300	60	40	40.0	25.8	47				
	AVR32-5			29.0	250	60	32	32.0	22.4	40	SN5T	SY5T	K5T	YI5M-1.5N
	AVR40-5			36.0	300	60	40	40.0	26.4	48				
	AVR50-5			45.0	350	75	50	50.0	31.4	58	SA5T	SY5T	K5T	YI5M-1.5N
	AVR60-5			54.0	400	75	60	60.0	36.4	69				

\* The toolholders are supplied with standard anvils. For Grooving, please use the anvils indicated in the table above. Holders with coolant channel available as standard. For ordering code see page 99.

## Internal Toolholders

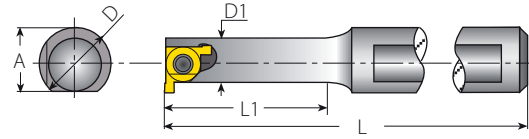
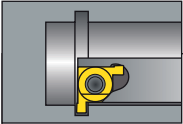

### Mini-L

Insert Size		Ordering Code	Dimensions mm					Anti-Vibration System	Spare Parts	
IC	RH	A	L	L1	D	D1				
5.0L	SNVR 10U-5L	9.4	81	16	10	6.2	No	SN5LT	K5LT	
	BNVR 10S-5L	9.4	87	22	10	6.2	Carbide Implanted			
	BNVR 10M-5L	9.4	97	31	10	6.2	Carbide Implanted			
	BNVR 10L-5L	9.4	109	43	10	6.2	Carbide Implanted			

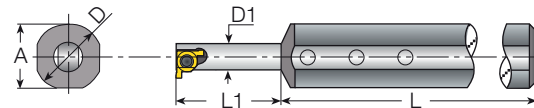
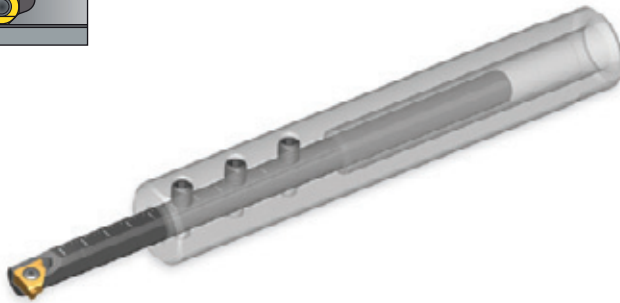
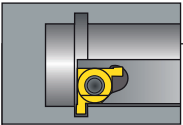

### Mini-L - Adjustable

Insert Size		Ordering Code	Dimensions mm					Spare Parts			
IC	Sleeve	Holder RH	A	L	L1	D	D1				
5.0L	SV16-6.2	BNVR6.2T-5L	15.6	100	8-44	16	6.2	SN5LT	K5LT	S4.0	K2.0



# Internal Toolholders



## Micro - Double Ended

### Spare Parts



Micro Insert Dia.	Shank Dia.	Ordering Code	Dimensions mm			Location Screw*			Clamping Screw x 3							
			d (mm)	D	L	L1	L0	Screw	M	Key	Screw	Key				
3	10	SMC10-3.0	80	9 - Short	89	4GISM8X28	28	K4.0	M4X0.7X4.0	K2.0						
	12	SMC12-3.0		16 - Medium	96						4GISM8X21	21				
	16	SMC16-3.0	95	9 - Short	104						4GISM8X49	49				
	20	SMC20-3.0		16 - Medium	111						4GISM8X42	42				
4	10	SMC10-4.0	80	9 - Short	89	4GISM8X28	28				K4.0	M4X0.7X4.0	K2.0			
	12	SMC12-4.0		16 - Medium	96	4GISM8X21	21									
	16	SMC16-4.0	95	9 - Short	104	4GISM8X49	49									
	20	SMC20-4.0		16 - Medium	111	4GISM8X42	42									
6	10	SMC10-6.0	80	9 - Short	89	4GISM8X28	28							K4.0	M4X0.7X4.0	K2.0
	12	SMC12-6.0		16 - Medium	96	4GISM8X21	21									
	16	SMC16-6.0	95	9 - Short	104	4GISM8X49	49									
	20	SMC20-6.0		16 - Medium	111	4GISM8X42	42									
8	12	SMC12-8.0	80	9 - Short	89	4GISM8X28	28	K4.0	M4X0.7X4.0	K2.0						
	16	SMC16-8.0		16 - Medium	96	4GISM8X21	21									
	20	SMC20-8.0	95	21 - Long	101	4GISM8X16	16									
	12	SMC12-8.0		9 - Short	104	4GISM8X49	49									
10	16	SMC16-10.0	95	16 - Medium	111	4GISM8X42	42				K4.0	M6X1.0X5.0	K3.0			
	20	SMC20-10.0		21 - Long	116	4GISM8X37	37									
	12	SMC12-10.0	95	12 - Short	107	4GISM8X33	33									
	16	SMC16-10.0		20 - Medium	115	4GISM8X25	25									
10	16	SMC16-10.0	95	28 - Long	123	4GISM8X17	17							K4.0	M6X1.0X5.0	K3.0
	20	SMC20-10.0		15 - Short	110	4GISM8X30	30									
	16	SMC16-10.0	95	25 - Medium	120	4GISM8X20	20									
	20	SMC20-10.0		35 - Long	130	4GISM8X10	10									

\* Every toolholder package contains the full range of location screws needed.

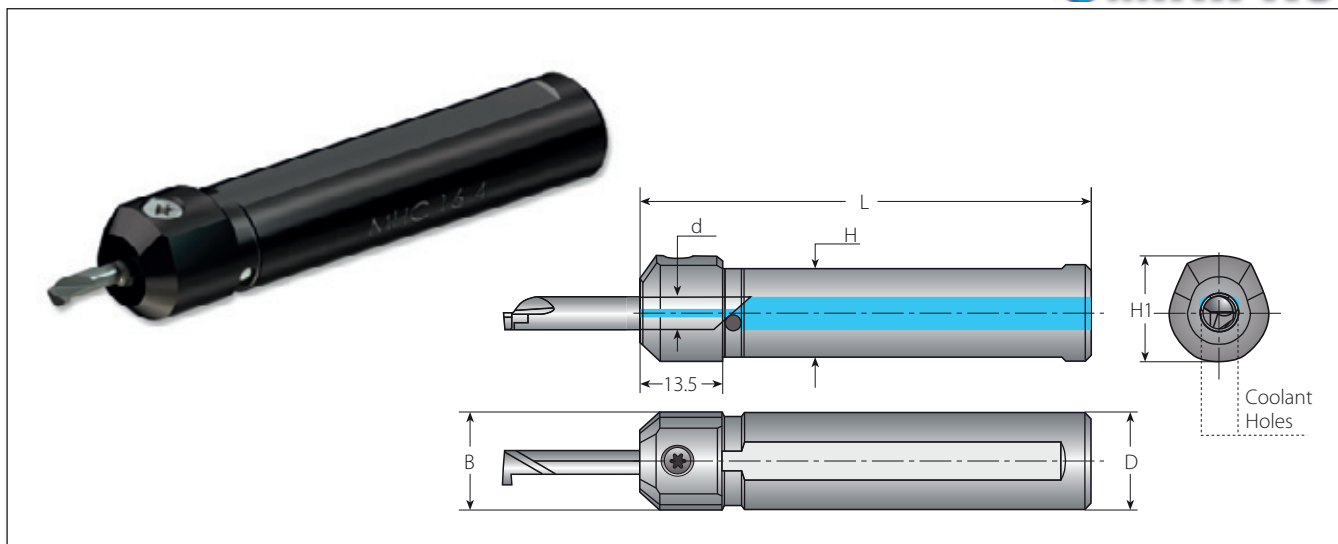

## Micro - Single Ended

Spare Parts **microscope**

Micro Insert Dia.	Ordering Code	Dimensions mm				Clamping Screw	Key
d (mm)		D=B	H1	H	L		
4.0	MHC 10-4	10	14	8.8	65	SL7DT15	KT15
	MHC 12-4	12	16	10.8	70		
	MHC 16-4	16	17.6	14.8	75		
	MHC 20-4	20	22	18.8	84		
5.0	MHC 10-5	10	14	8.8	65		
	MHC 12-5	12	16	10.8	70		
	MHC 16-5	16	18.6	14.8	75		
	MHC 20-5	20	22	18.8	84		
6.0	MHC 12-6	12	16	10.8	70		
	MHC 16-6	16	18.6	14.8	75		
	MHC 20-6	20	22	18.8	84		
7.0	MHC 16-7	16	18.6	14.8	75		
	MHC 20-7	20	22	18.8	84		

### Simple Clamping System

Simple and fool-proof, the new clamping system uses one large screw to secure the insert in the holder

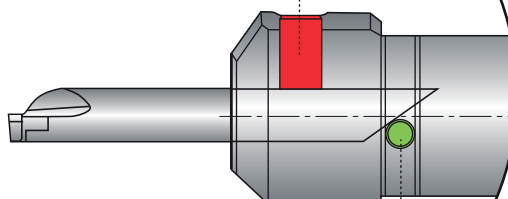

### Stopper Pin

Provides precise cutting edge height and perfect axial location



# Grooving

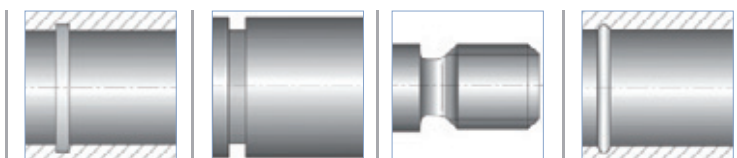





[> Technical Data](#)

## Recommended Grades, Cutting Speeds Vc [m/min] and Feed f [mm/rev]

Material Group	Vardex No.	Material	Hardness Brinell HB	Vc [m/min]				Feed [mm/rev]		
				Coated				Laydown & Mini	Micro & Microscope	
				VTX (Laydown)	VMX/VBX (Micro & Microscope)	VKP (Mini)	VHX (Mini)			
<b>P</b> Steel	1	Unalloyed steel	Low carbon (C=0.1-0.25%)	125	140-200	50-120	140-200	20-50	0.3	0.03
	2		Medium carbon (C=0.25-0.55%)	150	120-180	40-100	120-180	15-40	0.15	0.02
	3		High Carbon (C=0.55-0.85%)	170	110-180	30-80	110-180	15-30	0.05	0.01
	4	Low alloy steel (alloying elements ≤ 5%)	Non hardened	180	100-155	50-70	100-155	20-45	0.25	0.02
	5		Hardened	275	90-145	40-60	90-145	10-25	0.1	0.01
	6		Hardened	350	80-135	30-50	80-135	10-25	0.05	0.01
	7	High alloy steel (alloying elements >5%)	Annealed	200	70-115	30-50	65-115		0.2	0.02
	8		Hardened	325	50-100	25-40	50-100		0.05	0.01
	9	Cast steel	Low alloy (alloying elements <5%)	200	30-50	30-50	30-50	25-50	0.2	0.02
	10		High alloy (alloying elements >5%)	225	20-40	25-40	25-40	20-40	0.05	0.02
<b>M</b> Stainless Steel	11	Stainless steel Ferritic	Non hardened	200	70-120	60-100	80-120		0.2	0.01
	12		Hardened	330	60-95	40-60	55-95		0.05	0.01
	13	Stainless steel Austenitic	Austenitic	180	70-100	50-90	60-100		0.2	0.01
	14		Super Austenitic	200	40-90	40-60	50-90		0.05	0.01
	15	Stainless steel Cast ferritic	Non hardened	200	80-110	40-60	60-80		0.2	0.02
	16	Hardened	330	65-110	30-50	45-65		0.05	0.01	
	17	Cast austenitic	Austenitic	200	85-100	40-60	50-70		0.2	0.02
	18		Hardened	330	60-100	30-50	40-60		0.05	0.01
<b>K</b> Cast Iron	28	Malleable Cast iron	Ferritic (short chips)	130	70-120	50-70	60-80		0.2	0.02
	29		Pearlitic (long chips)	230	70-120	50-70	60-80		0.15	0.01
	30	Grey cast iron	Low tensile strength	180	70-120	50-70	60-80		0.2	0.02
	31		High tensile strength	260	60-100	40-60	40-70		0.1	0.15
	32	Nodular SG iron	Feritic	160	50-80	50-70	60-80		0.2	0.02
	33		Pearlitic	260	60-90	60-80	70-90		0.1	0.01
<b>N(K)</b> Non-Ferrous Metals	34	Aluminium alloys Wrought	Non aging	60	100-240	100-300	80-240	30-60	0.4	0.03
	35		Aged	100	80-170	100-150	100-170	25-50	0.1	0.03
	36	Aluminium alloys Cast	Cast	75	100-150	100-150	100-150	25-50	0.25	0.03
	37		Cast & aged	90	80-120	60-100	60-100	20-40	0.15	0.03
	38	Aluminium alloys Cast Si 13-22%	130	100-150	100-150	100-150	15-30	0.15	0.02	
	39	Copper and copper alloys	Brass	90	80-200	60-100	80-200	15-35	0.2	0.03
	40		Bronze and non leaded copper	100	80-200	60-100	80-200	15-35	0.15	0.03
<b>S(M)</b> Heat Resistant Material	19	High temperature alloys	Annealed (Iron based)	200	45-60	25-45	25-45		0.2	0.01
	20		Aged (Iron based)	280	35-50	20-30	20-30		0.05	0.01
	21		Annealed (Nickel or Cobalt based)	250	20-30	15-20	15-20		0.05	0.01
	22		Aged (Nickel or Cobalt based)	350	15-25	10-15	10-15		0.05	0.01
	23	Titanium alloys	Pure 99.5 Ti	400Rm	140-170	60-100	60-100		0.1	0.02
	24		α+β alloys	1050Rm	50-70	40-50	40-50		0.05	0.02
<b>H(K)</b> Hardned Material	25	Extra hard steel	Hardened & tempered	45-50HRc	45-60	20-40	20-40		0.02	0.01
	26			51-55HRc	40-50	20-35	20-35		0.02	0.01

### Grades and Their Application

Grade	Application Type	Sample	Grade	Application Type	Sample
VTX	General use carbide grade. A tough sub-micron substrate with TiAlN coating. Provides good fracture toughness and excellent wear resistance.		VKP	General use carbide grade for Mini inserts. TiN coated	
VMX	General use carbide grade for Micro inserts. TiN coated		VHX	General use HSS grade for Mini inserts. For Machining at low cutting speed. TiN coated	
VBX	General use carbide grade for Microscope inserts. TiCN coated				



# Boring



> Inserts

# BORING INSERTS

■ VARDEX Ordering Code System.....	Page 173
■ CD0W Inserts.....	Page 174
■ TD0W Inserts.....	Page 174
■ WC0W Inserts.....	Page 175
■ Boring - Micro.....	Page 176
■ Boring - Microscope.....	Page 177
■ Copy - Micro.....	Page 178
■ Chamfer - Micro.....	Page 178
■ Long Nose - Micro.....	Page 179
■ Long Nose - Microscope.....	Page 179
■ Back Edge - Micro.....	Page 180
■ Boredrill - Micro.....	Page 180

# Vardex Ordering Code System

## PowerBore Inserts

<b>T</b>	<b>D</b>	<b>0</b>	<b>W</b>	<b>41</b>	<b>14</b>	<b>VTX</b>
<b>1</b>	<b>2</b>	<b>3</b>	<b>4</b>	<b>5</b>	<b>6</b>	<b>7</b>
<b>1 - Insert Shape</b>	<b>2 - Clearance Angle</b>	<b>3 - Tolerance Class</b>		<b>4 - Insert Type</b>		
C - Diamond 80 deg. T - Triangle W - Trigon 80 deg.	C - 7 deg. D - 15 deg.	0 - Special Tolerance Class		W - Hole + Countersink		
<b>5 - Insert Dimension</b>	<b>6 - Corner Radius</b>	<b>7 - Carbide Grade</b>				
40-IC 0.156" - Thickness-1.02mm 41-IC 0.160" - Thickness-1.19mm 42-IC 0.156" - Thickness-1.57mm 50-IC 0.187" - Thickness-2.44mm	11- R 0.05 12- R 0.18 13- R 0.20 14- R 0.38	VTX				

## Micro Boring Inserts - Double Ended

<b>6.0</b>	<b>S</b>	<b>I</b>	<b>R</b>	<b>0.2</b>	<b>M</b>	<b>-</b>	<b>Bore</b>	<b>-</b>	<b>1</b>	<b>VMX</b>
<b>1</b>	<b>2</b>	<b>3</b>	<b>4</b>	<b>5</b>	<b>6</b>		<b>7</b>		<b>8</b>	<b>9</b>
<b>1 - Insert Dia.</b>	<b>2 - Tool Group</b>	<b>3 - Type of Insert</b>		<b>4 - RH or LH</b>		<b>5 - Corner Radius</b>				
3.0 4.0 6.0 8.0 10.0	S - Solid Carbide	I - Internal		R - Right Hand Insert L - Left Hand Insert		0.2				
<b>6 - Tool Length</b>	<b>7 - Tool Application</b>			<b>8 - Front Relief</b>		<b>9 - Carbide Grade</b>				
U - Ultra Short S - Short M - Medium L - Long	Bore - Boring Copy - Boring Copy Chamfer - Boring Chamfer Back - Back Edge 3527, 3537, 3547 - Long Nose BD - Bore Drill			1 - With Relief 0 - Without Relief		VMX				

## microscope Inserts - Single Ended

<b>M</b>	<b>4</b>	<b>17</b>	<b>BC</b>	<b>R</b>	<b>10</b>	<b>L09</b>	<b>R/L</b>	<b>VBX</b>	
<b>1</b>	<b>2</b>	<b>3</b>	<b>4</b>	<b>5</b>	<b>6</b>	<b>7</b>	<b>8</b>	<b>9</b>	
<b>1 - Product Line</b>	<b>2 - Insert Size</b>		<b>3 - Min Bore Dia.</b>		<b>4 - Type of Application</b>		<b>5 - 6 Nose Radius</b>		
M - Microscope	4, 5, 6, 7		1.7 - 7.2		BC - Boring CL - Copy Long Nose		0.1, 0.15, 0.2 (mm)		
<b>7 - Overhang Length</b>	<b>8 - RH or LH</b>		<b>9 - Carbide Grade</b>						
L09 - L50	R - RH L - LH		VBX						

# Boring



## Internal

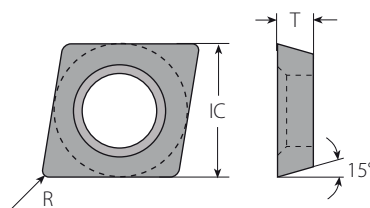
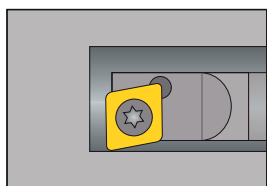

CD0W

### CD0W Inserts



Insert Size	Ordering Code	Dimensions [mm]		Insert Screw 
		R	T	
.156"	CD0W4011...	0.05	1.02	VS01
	CD0W4012...	0.18	1.02	
	CD0W4014...	0.38	1.02	

## Internal

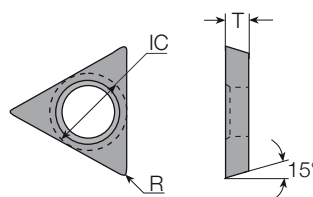
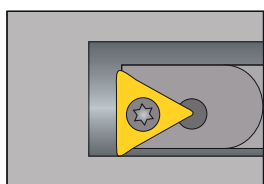

TD0W

### TD0W Inserts

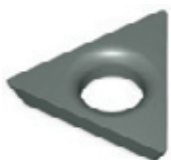

Insert Size	Ordering Code	Dimensions [mm]		Insert Screw 
		R	T	
.160"	TD0W4111...	0.05	1.19	VS01, VS40
	TD0W4112...	0.18	1.19	
	TD0W4114...	0.38	1.19	



# Boring



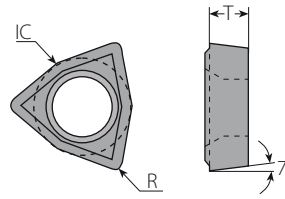
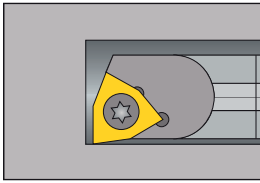

## Internal

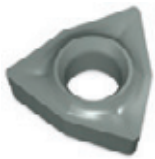

WCOW 4213, 4214

## WCOW Inserts



Insert Size	Ordering Code	Dimensions [mm]		Insert Screw 
IC		R	T	
.156"	WCOW4213...	0.20	1.57	VS40
	WCOW4214...	0.38	1.57	

## Internal

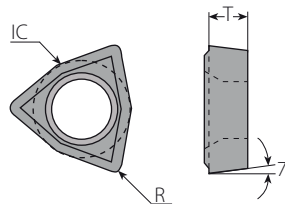
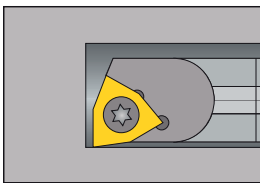

TDOW

## WCOW Inserts

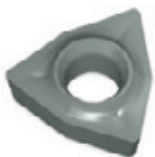

Insert Size	Ordering Code	Dimensions [mm]		Insert Screw 
IC		R	T	
.187"	WCOW5013...	0.20	2.44	VS41
	WCOW5014...	0.38	2.44	

# Micro Boring - Boring



## Internal

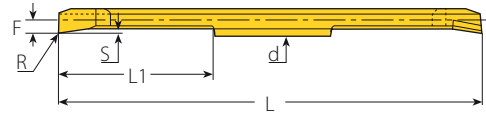
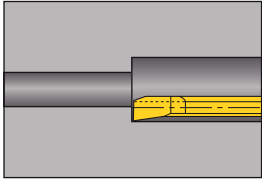

RH-Double Ended

## Micro - Double Ended

Insert dia.	Ordering Code	Dimensions mm					Min. Bore Dia.	Holder
d (mm)	RH	R	L1	L	S	F	mm	
3.0	3.0SIR0.1U-Bore-1...	0.1	6	36	0.40	0.22	2.0	SMC...-3.0
	3.0SIR0.1S-Bore-1...	0.1	9	36	0.40	0.22		
	3.0SIR0.2S-Bore-1...	0.2	9	36	0.66	1.42	3.2	
	3.0SIR0.2M-Bore-1...	0.2	16	50	0.66	1.42		
4.0	4.0SIR0.2S-Bore-1...	0.2	9	36	0.66	1.92	4.2	SMC...-4.0
	4.0SIR0.2M-Bore-1...	0.2	16	50	0.66	1.92		
	4.0SIR0.2L-Bore-1...	0.2	21	60	0.66	1.92		
6.0	6.0SIR0.2S-Bore-1...	0.2	9	36	0.77	2.92	6.2	SMC...-6.0
	6.0SIR0.2M-Bore-1...	0.2	16	50	0.77	2.92		
	6.0SIR0.2L-Bore-1...	0.2	21	60	0.77	2.92		
8.0	8.0SIR0.2S-Bore-1...	0.2	12	54	0.82	3.92	8.2	SMC...-8.0
	8.0SIR0.2M-Bore-1...	0.2	20	70	0.82	3.92		
	8.0SIR0.2L-Bore-1...	0.2	28	86	0.82	3.92		
10.0	10.0SIR0.2S-Bore-1...	0.2	15	60	1.00	4.92	10.2	SMC...-10.0
	10.0SIR0.2M-Bore-1...	0.2	25	80	1.00	4.92		
	10.0SIR0.2L-Bore-1...	0.2	35	100	1.00	4.92		

# Micro Boring - Boring



## Internal

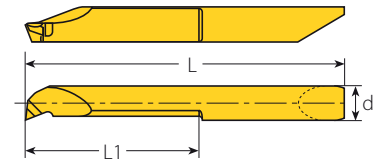
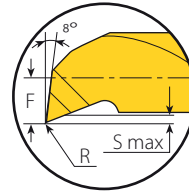
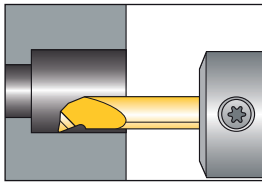

RH-Single Ended

## Micro - Single Ended

microscope

Insert dia.	Ordering Code	Dimensions mm					Min. Bore Dia.	Holder
d (mm)	RH/LH	R	L1	L	S max	F	mm	
4.0	M410BC R10 L06R/L	0.1	6	28	0.15	0.49	1.0	
	M415BC R10 L09R/L		9	28		0.69	1.5	
	M417BC R10 L09R/L		9	28		0.7	1.7	
	M422BC R10 L09R/L	0.1	9	28	0.15	0.95	2.2	
	M422BC R10 L14R/L		14	33				
	M432BC R15 L10R/L	0.15	10	28	0.15	1.45	3.2	
	M432BC R15 L16R/L		16	33				
	M432BC R15 L20R/L		20	39				
	M442BC R15 L10R/L	0.15	10	28	0.3	1.95	4.2	
	M442BC R15 L16R/L		16	33				
	M442BC R15 L21R/L		21	39				
	M442BC R15 L26R/L		26	45				
5.0	M552BC R20 L10R/L	0.2	10	35	0.5	2.45	5.2	
	M552BC R20 L16R/L		16	41				
	M552BC R20 L21R/L		21	46				
	M552BC R20 L26R/L		26	51				
	M552BC R20 L30R/L		30	55				
	M552BC R20 L35R/L		35	60				
6.0	M662BC R20 L16R/L	0.2	16	42	0.5	2.95	6.2	
	M662BC R20 L21R/L		21	47				
	M662BC R20 L26R/L		26	52				
	M662BC R20 L30R/L		30	56				
	M662BC R20 L35R/L		35	61				
	M662BC R20 L40R/L		40	66				
7.0	M772BC R20 L25R/L	0.2	25	51	0.5	3.45	7.2	
	M772BC R20 L35R/L		35	61				
	M772BC R20 L40R/L		40	66				
	M772BC R20 L45R/L		45	71				
	M772BC R20 L50R/L		50	76				

Microscope Left-Handed tools available upon request (Example: M417BC R10L09L...)

Boring Inserts

# Micro Boring Copy



## Internal

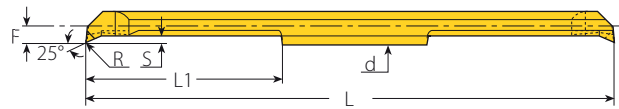
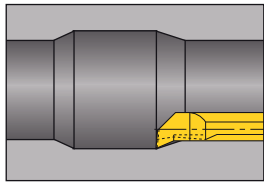

RH-Double Ended

## Micro - Double Ended

Insert dia.	Ordering Code	Dimensions mm					Min. Bore Dia.	Holder
d (mm)	RH	R	L1	L	S	F	mm	
4.0	4.0SIR0.2S-Copy-1...	0.2	9	36	1.0	1.92	4.2	SMC...-4.0
	4.0SIR0.2M-Copy-1...	0.2	16	50	1.0	1.92		
	4.0SIR0.2L-Copy-1...	0.2	21	60	1.0	1.92		
6.0	6.0SIR0.2S-Copy-1...	0.2	9	36	1.3	2.92	7.0	SMC...-6.0
	6.0SIR0.2M-Copy-1...	0.2	16	50	1.3	2.92		
	6.0SIR0.2L-Copy-1...	0.2	21	60	1.3	2.92		

# Micro Boring Chamfer

## Internal

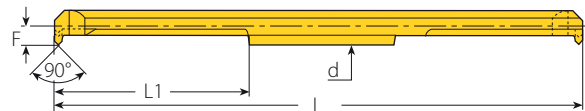
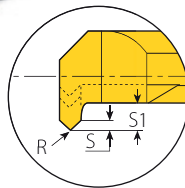
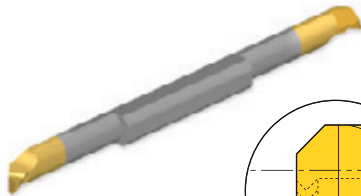
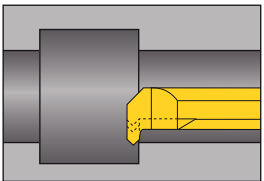

RH-Double Ended

## Micro - Double Ended

Insert dia.	Ordering Code	Dimensions mm						Min. Bore Dia.	Holder
d (mm)	RH	R	L1	L	F	S1	S	mm	
4.0	4.0SIR0.2S-Chamfer-0...	0.2	9	36	1.92	1.0	0.40	4.2	SMC...-4.0
	4.0SIR0.2M-Chamfer-0...	0.2	16	50	1.92	1.0	0.40		
	4.0SIR0.2L-Chamfer-0...	0.2	21	60	1.92	1.0	0.40		
6.0	6.0SIR0.2S-Chamfer-0...	0.2	9	36	2.92	1.2	0.70	6.2	SMC...-6.0
	6.0SIR0.2M-Chamfer-0...	0.2	16	50	2.92	1.2	0.70		
	6.0SIR0.2L-Chamfer-0...	0.2	21	60	2.92	1.2	0.70		

# Micro Boring - Long Nose



## Internal

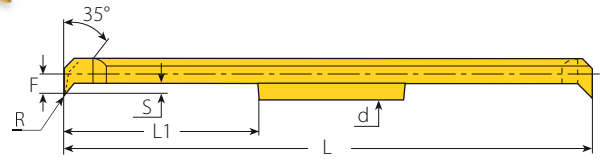
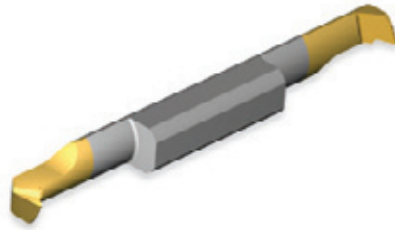
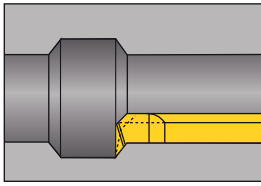

RH-Double Ended

## Micro - Double Ended

Insert dia. d(mm)	Ordering Code	Dimensions mm					Min. Bore Dia. mm	Holder
	RH	R	L1	L	F	S		
6.0	6.0SIR0.2S-3527-1...	0.2	9	36	2.7	2.92	6.9	SMC...-6.0
	6.0SIR0.2M-3527-1...	0.2	16	50	2.7	2.92		
	6.0SIR0.2L-3527-1...	0.2	21	60	2.7	2.92		
8.0	8.0SIR0.2S-3537-1...	0.2	12	54	3.7	3.92	8.9	SMC...-8.0
	8.0SIR0.2M-3537-1...	0.2	20	70	3.7	3.92		
	8.0SIR0.2L-3537-1...	0.2	28	86	3.7	3.92		
10.0	10.0SIR0.2S-3547-1...	0.2	15	60	4.7	4.92	10.8	SMC...-10.0
	10.0SIR0.2M-3547-1...	0.2	25	80	4.7	4.92		
	10.0SIR0.2L-3547-1...	0.2	35	100	4.7	4.92		

# Micro Boring - Long Nose

## Internal

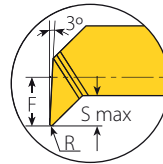
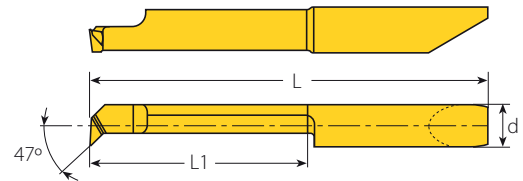
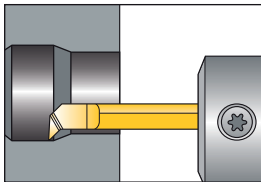

RH-Single Ended

## Micro - Single Ended

microscope

Insert dia. d(mm)	Ordering Code	Dimensions mm					Min. Bore Dia. mm	Holder
	RH/LH	R	L1	L	S max	F		
4.0	M442CL R15 L10R/L	0.15	10	28	0.75	1.95	4.2	MHC...-4
	M442CL R15 L16R/L	0.15	16	33				
	M442CL R15 L21R/L	0.15	21	39				
5.0	M552CL R20 L16R/L	0.2	16	41	0.95	2.45	5.2	MHC...-5
	M552CL R20 L25R/L	0.2	25	51				
6.0	M662CL R20 L16R/L	0.2	16	42	1.75	2.95	6.2	MHC...-6
	M662CL R20 L21R/L	0.2	21	47				
	M662CL R20 L30R/L	0.2	30	56				

Microscope Left-Handed tools available upon request (Example: M442CL R15 L10L)

## Micro Boring - Back Edge



### Internal

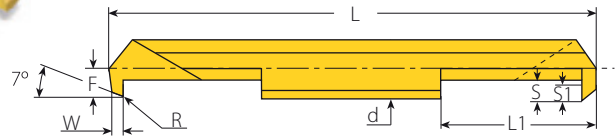
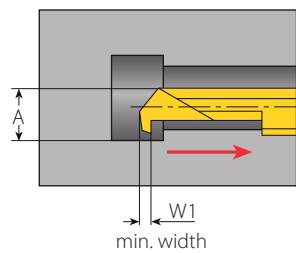

RH-Double Ended

### Micro - Double Ended

Insert dia.	Ordering Code	Dimensions mm									Min. Bore Dia.	Holder
d(mm)	RH	R	L1	L	A	W	W1	S	S1	F	mm	
3.0	3.0SIR0.2S-Back-1...	0.2	9	36	3.42	1.5	1.81	0.8	0.6	1.42	3.2	SMC...-3.0
	3.0SIR0.2M-Back-1...	0.2	16	50								
4.0	4.0SIR0.2S-Back-1...	0.2	9	36	4.44	2.0	2.34	1.3	1.0	1.92	4.2	SMC...-4.0
	4.0SIR0.2M-Back-1...	0.2	16	50								
	4.0SIR0.2L-Back-1...	0.2	21	60								
6.0	6.0SIR0.2S-Back-1...	0.2	9	36	6.44	2.0	2.46	1.9	1.6	2.92	6.2	SMC...-6.0
	6.0SIR0.2M-Back-1...	0.2	16	50								
	6.0SIR0.2L-Back-1...	0.2	21	60								

## Micro Boring - Boredrill

### Internal

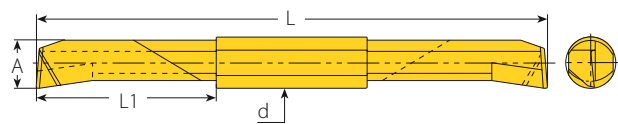
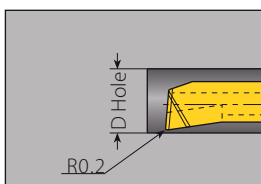

RH-Double Ended

### Micro - Double Ended

Insert dia.	Ordering Code	Dimensions mm			Min. Bore Dia.	Holder
d(mm)	RH	L1	L	A	mm	
4.0	4.0SIR0.2M-BD-1...	16	50	3.53	3.74	SMC...-4.0
6.0	6.0SIR0.2M-BD-1...	16	50	5.20	5.80	SMC...-6.0
	6.0SIR0.2L-BD-1...	21	60			
8.0	8.0SIR0.2S-BD-1...	12	54	6.90	7.80	SMC...-8.0
	8.0SIR0.2M-BD-1...	20	70			
	8.0SIR0.2L-BD-1...	28	86			



# Boring

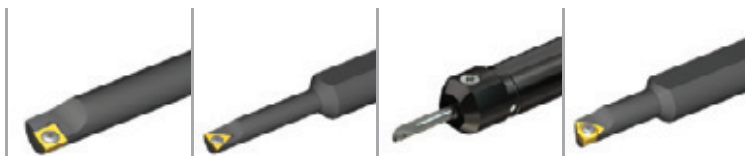

> Toolholders



- VARDEX Ordering Code System ..... Page 182
- PowerBore Boring Bars for CD0W Inserts ..... Page 183
- PowerBore Boring Bars for TD0W Inserts ..... Page 184
- PowerBore Boring Bars for WC0W Inserts (4213, 4214) ..... Page 185
- PowerBore Boring Bars for WC0W Inserts (5013, 5014) ..... Page 186
- Toolholders - Micro Double Ended ..... Page 187
- Toolholders - Microscope Single Ended ..... Page 188

## VarDEX Ordering Code System

### PowerBore Toolholders

<b>C</b>	<b>05</b>	-	<b>D</b>	<b>T</b>	<b>J</b>	-	-	<b>5</b>
1	2		3	4	5			6

<b>1 - Shank Style</b>	<b>2 - Shank Dia.</b>	<b>3 - Bar Dia. [Di]</b>	<b>4 - Insert Shape</b>	<b>5 - Holder Length [L<sub>2</sub>]</b>
C - Carbide S - Steel	04 - 4.0 mm 05 - 5.0 mm 06 - 6.0 mm 08 - 8.0 mm 10 - 10.0 mm 12 - 12.0 mm	A - 4.2 B - 4.6 C - 4.8 D - 5.0 E - 5.2 F - 6.0 G - 6.4 H - 7.9 J - 8.0	C - Diamond 80 Deg.  T - Triangle  W - Trigon 80 Deg. 	A - 57 C - 64 D - 70 E - 76 G - 89 J - 102 P - 152
				<b>6 - Front Relief Angle</b>
				0, 5, 7

## Micro and microscope

<b>S</b>	<b>M</b>	<b>C</b>	<b>16</b>	-	<b>3</b>
1	2	3	4		5

<b>1 - Holder Shape</b>	<b>2 - Holder Type</b>	<b>3 - Cooling</b>	<b>4 - Holder Dia.</b>	<b>5 - Bore Size</b>
S - Sleeve (Double Ended) M - Microscope (Single Ended)	M - Micro (Double Ended) H - Microscope (Single Ended)	C - Coolant Channel	10, 12, 16, 20	Micro Size 3, 4, 5, 6, 7, 8, 10



# PowerBore Boring Bars for CD0W Inserts

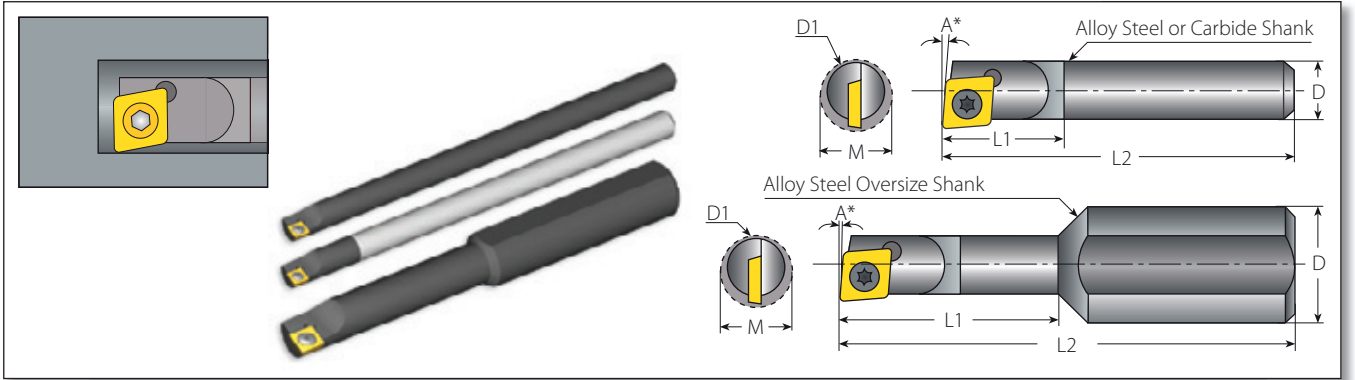

## Alloy Steel Shanks - Standard Size

Spare Parts

Shank	Ordering Code	Dimensions mm						Insert Type	Screw	Torx Key
		A	D	D1	M	L2	L1			
		angle	shank dia.	bar dia.	min.bore	overall length	bar length			
5.0	S05-ACC--7	7°	5.0	4.2	4.6	64	12	CD0W	VS01	VT51
	S05-BCC--5	5°	5.0	4.6	5.3	64				
	S05-DCC--5	5°	5.0	5.0	6.1	64				
	S05-DCC--0	0°	5.0	5.0	6.4	64				
6.0	S06-FCE--5	5°	6.0	6.0	7.0	76	D1=D			
	S06-FCE--0	0°	6.0	6.0	7.3	76				



## Solid Carbide Shank with Alloy Steel Head - Standard Size

Spare Parts

Shank	Ordering Code	Dimensions mm						Insert Type	Screw	Torx Key
		A	D	D1	M	L2	L1			
		angle	shank dia.	bar dia.	min.bore	overall length	bar length			
4.0	C04-ACP--7	7°	4.0	4.2	4.6	152	12	CD0W	VS01	VT51
5.0	C05-CCJ--5	5°	5.0	4.8	5.5	102				
	C05-DCJ--5	5°	5.0	5.0	6.1	102				
	C05-DCJ--0	0°	5.0	5.0	6.5	102				
6.0	C06-FCJ--5	5°	6.0	6.0	7.0	102	D1=D			
	C06-FCJ--0	0°	6.0	6.0	7.3	102				



## Alloy Steel Shanks- Oversize

Spare Parts

Shank	Ordering Code	Dimensions mm						Insert Type	Screw	Torx Key
		A	D	D1	M	L2	L1			
		angle	shank dia.	bar dia.	min.bore	overall length	bar length			
8.0	S08-BCA--5	5°	8.0	4.6	5.5	57	25	CD0W	VS01	VT51
	S08-ECA--5	5°	8.0	5.2	5.8	57				
	S08-ECA--0	0°	8.0	5.2	6.2	57				
	S08-GCC--5	5°	8.0	6.4	7.4	64	32			
	S08-GCC--0	0°	8.0	6.4	7.6	64				

\* 5° angle for facing and thru-hole boring  
 \* 0° angle for thru-hole boring and boring to a shoulder

# PowerBore Boring Bars for TD0W Inserts

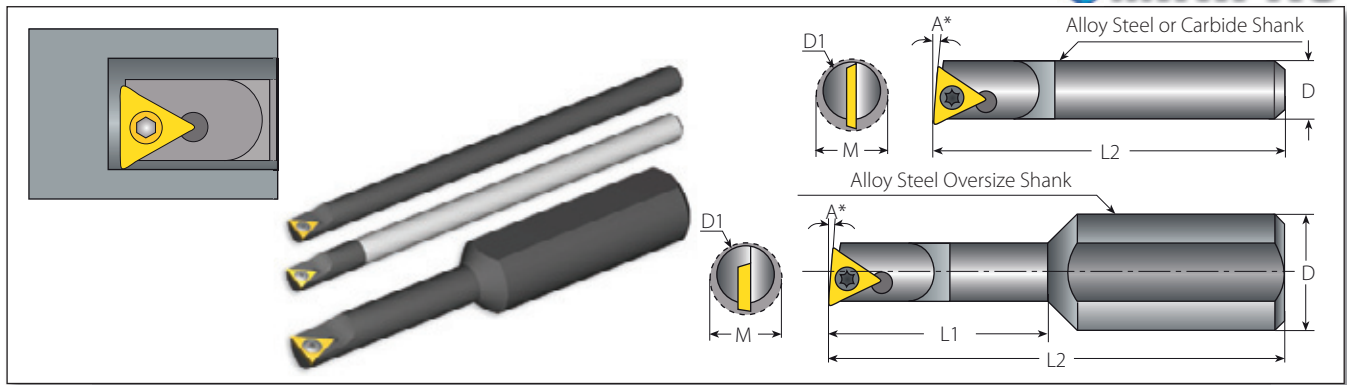

## Alloy Steel Shanks - Standard Size

Spare Parts

Shank	Ordering Code	Dimensions mm				Insert Type	Screw	Torx Key
		A	D=D1	M	L2			
		angle	bar dia.	min.bore	overall length			
5.0	S05-DTG--5	5°	5.0	7.1	89	TD0W	VS01	VT51
	S05-DTG--0	0°	5.0	7.1	89			
6.0	S06-FTJ--5	5°	6.0	7.3	102			
	S06-FTJ--0	0°	6.0	7.3	102			
8.0	S08-JTJ--5	5°	8.0	9.2	102			
	S08-JTJ--0	0°	8.0	9.2	102			



## Solid Carbide Shank with Alloy Steel Head - Standard Size

Spare Parts

Shank	Ordering Code	Dimensions mm				Insert Type	Screw	Torx Key
		A	D=D1	M	L2			
		angle	bar dia.	min.bore	overall length			
5.0	C05-DTJ--5	5°	5.0	7.1	102	TD0W	VS01	VT51
	C05-DTJ--0	0°	5.0	7.1	102			
6.0	C06-FTJ--5	5°	6.0	7.3	102			
	C06-FTJ--0	0°	6.0	7.3	102			
8.0	C08-JTJ--5	5°	8.0	9.2	102			
	C08-JTJ--0	0°	8.0	9.2	102			



## Alloy Steel Shanks - Oversize

Spare Parts

Shank	Ordering Code	Dimensions mm						Insert Type	Screw	Torx Key
		A	D	D1	M	L2	L1			
		angle	shank dia.	bar dia.	min.bore	overall length	bar length			
12.0	S12-ETC--5	5°	12.0	5.2	6.9	64	25	TD0W	VS01	VT51
	S12-ETC--0	0°	12.0	5.2	6.9	64				
	S12-GTD--5	5°	12.0	6.4	7.6	70	32			
	S12-GTD--0	0°	12.0	6.4	7.6	70				
	S12-HTE--5	5°	12.0	7.9	9.1	76	38			
	S12-HTE--0	0°	12.0	7.9	9.1	76				

Boring Holders

## PowerBore Boring Bars for WC0W Inserts (4213, 4214)

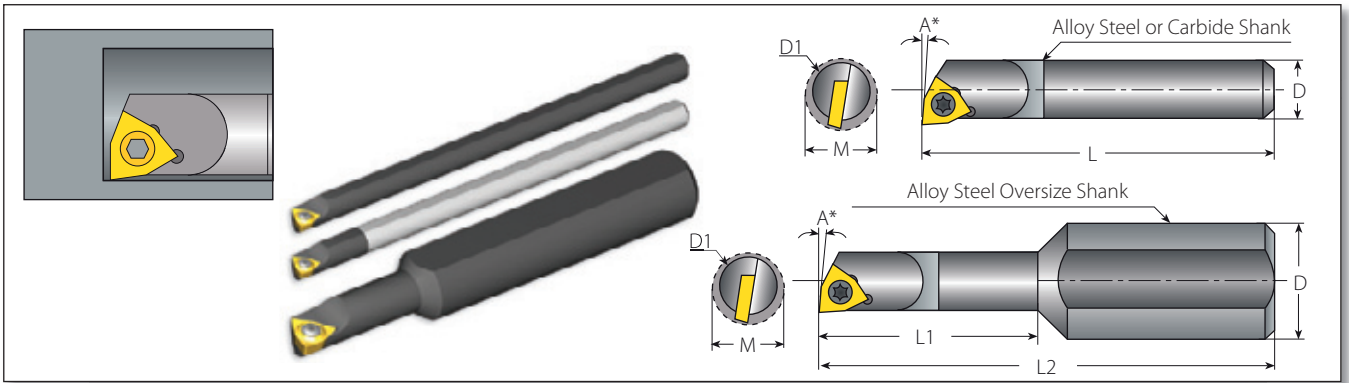

**PowerBore**

Spare Parts

### Alloy Steel Shanks - Standard Size

Shank	Ordering Code	Dimensions mm				Insert Type	Screw	Torx Key			
		A	D=D1	M	L						
		angle	bar dia.	min.bore	bar length						
5.0	S05-DWC--5	5°	5.0	6.1	64	WC0W4213 WC0W4214	VS40	VT51			
	S05-DWC--0	0°	5.0	6.4							
6.0	S06-FWJ--5	5°	6.0	7.0	102						
	S06-FWJ--0	0°	6.0	7.3							

**PowerBore**

Spare Parts

### Solid Carbide Shank with Alloy Steel Head - Standard Size

Shank	Ordering Code	Dimensions mm				Insert Type	Screw	Torx Key			
		A	D=D1	M	L						
		angle	bar dia.	min.bore	bar length						
5.0	C05-DWJ--5	5°	5.0	6.1	102	WC0W4213 WC0W4214	VS40	VT51			
	C05-DWJ--0	0°	5.0	6.4							
6.0	C06-FWJ--5	5°	6.0	7.0	102						
	C06-FWJ--0	0°	6.0	7.3							

**PowerBore**

Spare Parts

### Alloy Steel Shanks - Oversize

Shank	Ordering Code	Dimensions mm						Insert Type	Screw	Torx Key			
		A	D	D1	M	L2	L1						
		angle	shank dia.	bar dia.	min.bore	overall length	bar length						
10.0	S10-EWA--5	5°	10.0	5.2	5.8	57	13	WC0W4213 WC0W4214	VS40	VT51			
	S10-EWA--0	0°	10.0	5.2	6.2	57							
	S10-GWC--5	5°	10.0	6.4	7.4	64	19						
	S10-GWC--0	0°	10.0	6.4	7.6	64							

\* 5° angle for facing and thru-hole boring  
\* 0° angle for thru-hole boring and boring to a shoulder

## PowerBore Boring Bars for WC0W Inserts (5013, 5014)

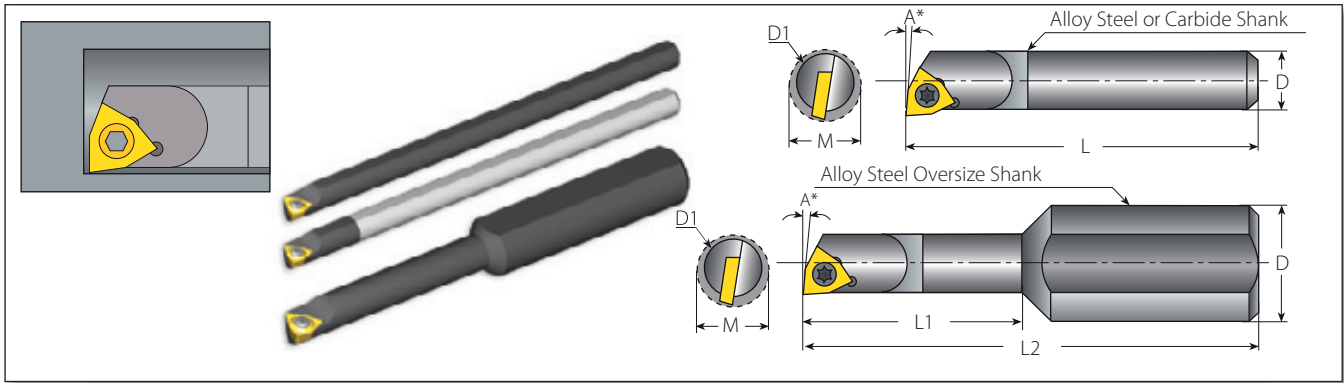

**PowerBore**

### Alloy Steel Shanks - Standard Size

Spare Parts

Shank	Ordering Code	Dimensions mm				Insert Type	Screw	Torx Key
		A	D=D1	M	L			
		angle	bar dia.	min.bore	bar length			
8.0	S08-JWJ--5	5°	8.0	9.2	102	WC0W5013	VS41	VT51
	S08-JWJ--0	0°	8.0	9.2		WC0W5014		

**PowerBore**

### Solid Carbide Shank with Alloy Steel Head - Standard Size

Spare Parts

Shank	Ordering Code	Dimensions mm				Insert Type	Screw	Torx Key
		A	D=D1	M	L			
		angle	bar dia.	min.bore	bar length			
8.0	C08-JWJ--5	5°	8.0	9.2	102	WC0W5013	VS41	VT51
	C08-JWJ--0	0°	8.0	9.2		WC0W5014		

**PowerBore**

### Alloy Steel Shanks - Oversize

Spare Parts

Shank	Ordering Code	Dimensions mm						Insert Type	Screw	Torx Key
		A	D	D1	M	L2	L1			
		angle	shank dia	bar dia.	min.bore	overall length	bar length			
10.0	S10-HWE--5	5°	10.0	7.9	9.2	76	38	WC0W5013	VS41	VT51
	S10-HWE--0	0°	10.0	7.9	9.2	76		WC0W5014		

# Internal Toolholders

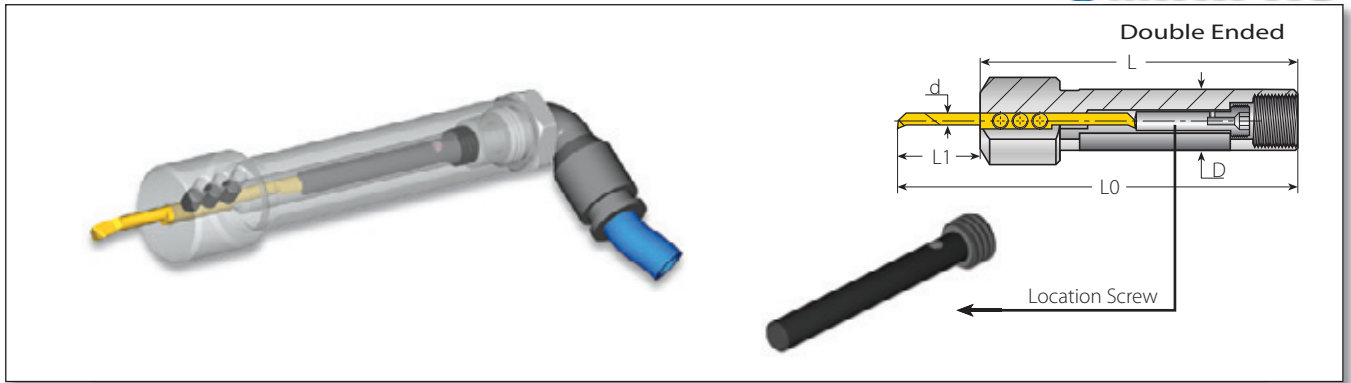

## Micro - Double Ended

### Spare Parts



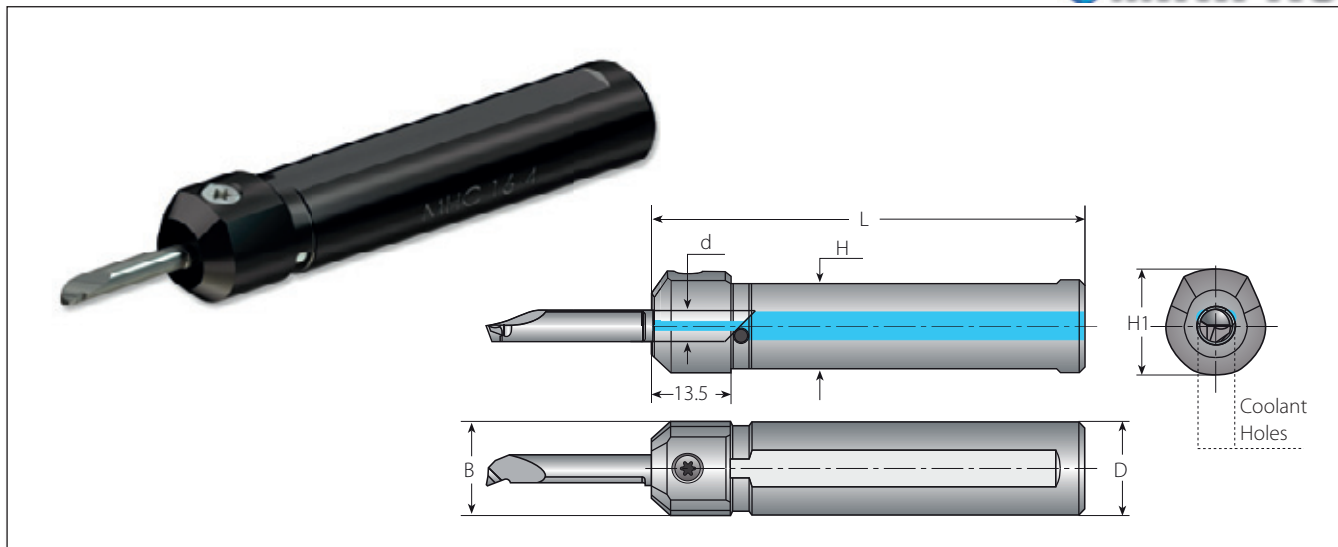

Micro Insert Dia.	Shank Dia.	Ordering Code	Dimensions mm			Location Screw*			Clamping Screw x 3					
d (mm)	D		L	L1	L0	Screw	M	Key	Screw	Key				
3	10	SMC10-3.0	80	9 - Short	89	4GISM8X28	28	K4.0	M4X0.7X4.0	K2.0				
	12	SMC12-3.0		16 - Medium	96	4GISM8X21	21							
	16	SMC16-3.0	95	9 - Short	104	4GISM8X49	49							
	20	SMC20-3.0		16 - Medium	111	4GISM8X42	42							
4	10	SMC10-4.0	80	9 - Short	89	4GISM8X28	28				K4.0	M4X0.7X4.0	K2.0	
	12	SMC12-4.0		16 - Medium	96	4GISM8X21	21							
	16	SMC16-4.0	95	9 - Short	104	4GISM8X49	49							
	20	SMC20-4.0		16 - Medium	111	4GISM8X42	42							
6	12	SMC12-6.0	80	9 - Short	89	4GISM8X28	28		K4.0	M4X0.7X4.0				K2.0
				16 - Medium	96	4GISM8X21	21							
				21 - Long	101	4GISM8X16	16							
	16	SMC16-6.0	95	9 - Short	104	4GISM8X49	49							
20	SMC20-6.0	16 - Medium		111	4GISM8X42	42								
8	16	SMC16-8.0	95	12 - Short	107	4GISM8X33	33	K4.0				M6X1.0X5.0	K3.0	
				20 - Medium	115	4GISM8X25	25							
				28 - Long	123	4GISM8X17	17							
	20	SMC20-8.0	95	15 - Short	110	4GISM8X30	30							
10	SMC16-10.0	25 - Medium		120	4GISM8X20	20								
		20	SMC20-10.0	35 - Long	130	4GISM8X10	10							

\* Every toolholder package contains the full range of location screws needed.



## Micro - Single Ended

Spare Parts **microscope**

Micro Insert Dia.	Ordering Code	Dimensions (mm)					
d (mm)		D=B	H1	H	L	Clamping Screw	Key
4.0	MHC 10-4	10	14	8.8	65	SL7DT15	KT15
	MHC 12-4	12	16	10.8	70		
	MHC 16-4	16	17.6	14.8	75		
	MHC 20-4	20	22	18.8	84		
5.0	MHC 10-5	10	14	8.8	65		
	MHC 12-5	12	16	10.8	70		
	MHC 16-5	16	18.6	14.8	75		
	MHC 20-5	20	22	18.8	84		
6.0	MHC 12-6	12	16	10.8	70		
	MHC 16-6	16	18.6	14.8	75		
	MHC 20-6	20	22	18.8	84		
7.0	MHC 16-7	16	18.6	14.8	75		
	MHC 20-7	20	22	18.8	84		

### Simple Clamping System

Simple and fool-proof, the new clamping system uses one large screw to secure the insert in the holder.....

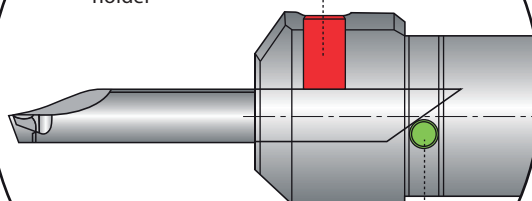

### Stopper Pin

Provides precise cutting edge height and perfect axial location

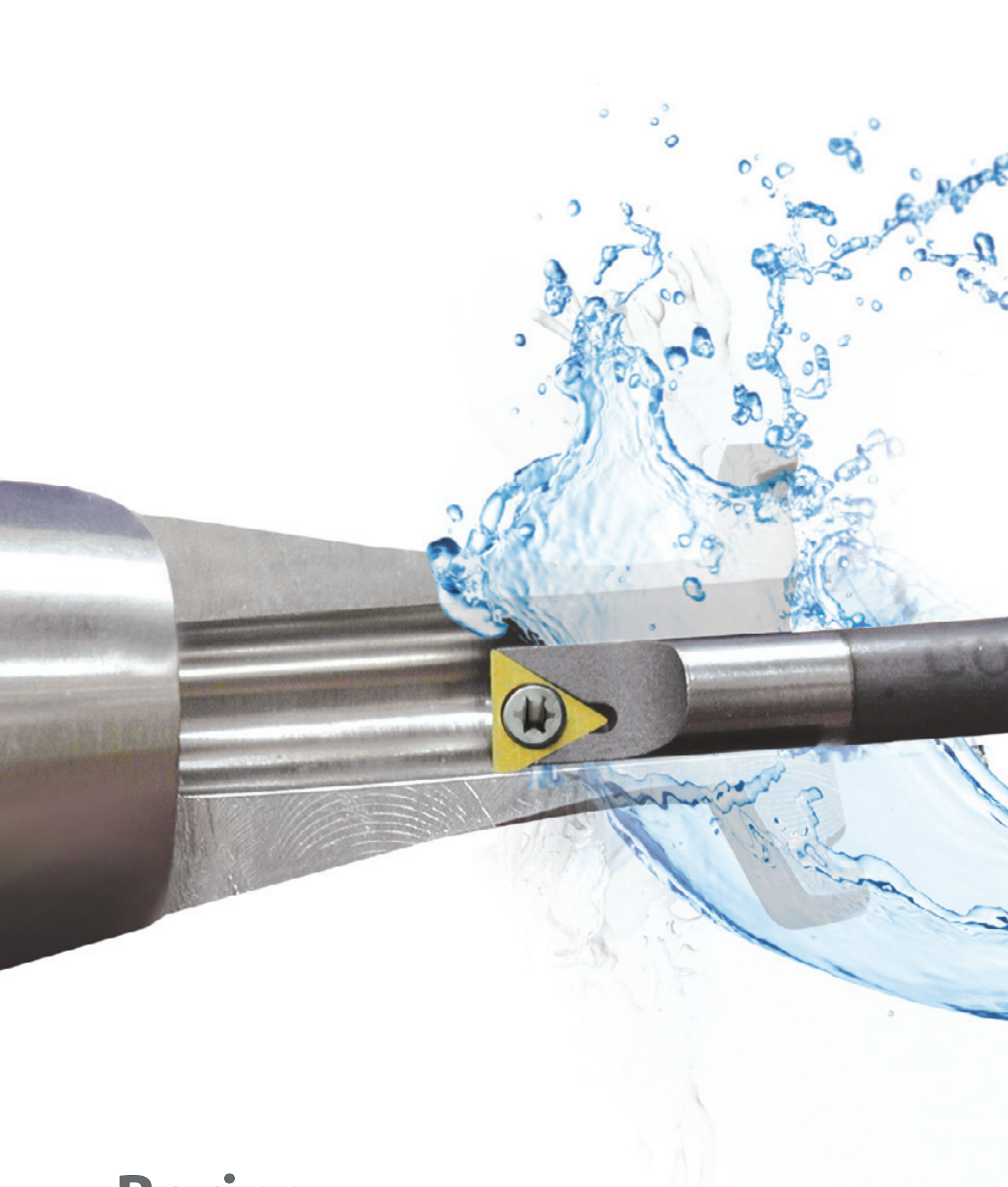



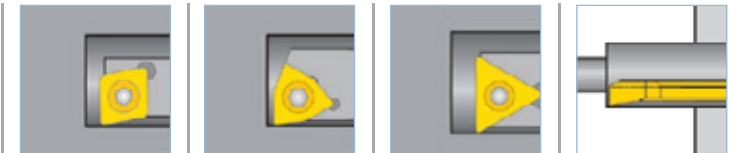

# Boring



> **Technical Data**



- Spare Parts PowerBore .....Page 190
- Recommended Cutting Data - PowerBore and Micro.....Page 191
- Grades and Their Applications.....Page 191

Spare Parts PowerBore					
Insert	Boring Bar	Insert	Torx Screw	Screw Description	Torx key
	A	CD0W	VS01	1-72 Oval X 2.77LG.	VT51
	B	TD0W Min. Bore 7.1 > Bore 7.1	VS01 VS40	1-72 Oval X 2.77LG. M2 X 0.4 X 3.86LG.	
	E	WC0W4213, WC0W4214	VS40	M2 X 0.4 X 3.86LG.	
	F	WC0W5013, WC0W5014	VS41	M2 X 0.4 X 4.90LG.	



## Recommended Grades, Cutting Speeds Vc [m/min], Feed f [mm/rev] and Max Depth [mm]

Material Group	Vardex No.	Material	Hardness Brinell HB	Vc [m/min]		Feed [mm/rev]		Max Depth [mm]				
				Coated		Power Bore	Micro/ Microscope	PowerBore			Micro / Microscope	
				VTX (PowerBore)	VMX/ VBX (Micro & Microscope)			CD0W	TD0W	WD0W		
<b>P</b> Steel	1	Unalloyed steel	Low carbon (C=0.1-0.25%)	125	115-190	50-120	0.25	0.05	0.5	0.45	0.6	0.4
	2		Medium carbon (C=0.25-0.55%)	150	100-175	40-100	0.2	0.04	0.5	0.45	0.6	0.4
	3		High Carbon (C=0.55-0.85%)	170	90-165	30-80	0.15	0.03	0.5	0.45	0.6	0.4
	4	Low alloy steel (alloying elements ≤5%)	Non hardened	180	85-145	50-70	0.2	0.04	0.4	0.35	0.5	0.3
	5		Hardened	275	75-140	40-60	0.15	0.04	0.4	0.35	0.5	0.3
	6		Hardened	350	70-135	30-50	0.1	0.03	0.4	0.35	0.5	0.3
	7	High alloy steel (alloying elements >5%)	Annealed	200	70-110	30-50	0.1	0.04	0.2	0.18	0.4	0.15
	8		Hardened	325	50-100	25-40	0.05	0.03	0.2	0.18	0.4	0.15
	9	Cast steel	Low alloy (alloying elements <5%)	200	75-140	30-50	0.25	0.04	0.2	0.18	0.4	0.15
	10		High alloy (alloying elements >5%)	225	60-120	25-40	0.1	0.04	0.2	0.18	0.4	0.15
<b>M</b> Stainless Steel	11	Stainless steel	Non hardened	200	70-130	60-100	0.2	0.04	0.25	0.22	0.5	0.2
	12		Feritic	Hardened	330	60-115	40-60	0.08	0.03	0.2	0.18	0.4
	13	Stainless steel	Austenitic	180	90-140	50-90	0.2	0.04	0.25	0.22	0.5	0.2
	14		Austenitic	Super Austenitic	200	40-110	40-60	0.08	0.04	0.2	0.18	0.4
	15	Stainless steel	Non hardened	200	90-120	40-60	0.2	0.04	0.25	0.22	0.5	0.2
	16		Cast feritic	Hardened	330	65-110	30-50	0.08	0.03	0.2	0.18	0.4
	17	Stainless steel	Austenitic	200	85-110	40-60	0.2	0.04	0.25	0.22	0.5	0.2
	18		Cast austenitic	Hardened	330	60-100	30-50	0.08	0.03	0.2	0.18	0.4
<b>K</b> Cast Iron	28	Malleable Cast iron	Ferritic (short chips)	130	70-160	50-70	0.15	0.02	0.3	0.3	0.4	0.25
	29		Pearlitic (long chips)	230	60-145	50-70	0.10	0.01	0.3	0.3	0.4	0.25
	30	Grey Cast iron	Low tensile strength	180	70-130	50-70	0.15	0.02	0.5	0.45	0.6	0.4
	31		High tensile strength	260	60-115	40-60	0.1	0.01	0.5	0.45	0.6	0.4
	32	Nodular SG iron	Ferritic	160	125-160	50-70	0.15	0.02	0.5	0.45	0.6	0.4
	33		Pearlitic	260	90-120	60-80	0.1	0.01	0.5	0.45	0.6	0.4
<b>N(K)</b> Non-Ferrous Metals	34	Wrought Aluminium alloys	Non aging	60	100-365	100-300	0.3	0.03	0.76	0.63	1.0	0.5
	35		Aged	100	80-220	100-150	0.2	0.03	0.76	0.63	1.0	0.5
	36	Aluminium alloys	Cast	75	200-400	100-150	0.3	0.03	0.76	0.63	1.0	0.5
	37		Cast & aged	90	200-280	60-100	0.2	0.03	0.76	0.63	1.0	0.5
	38		Aluminium alloys	Cast Si 13-22%	130	60-180	100-150	0.3	0.02	0.76	0.63	1.0
	39	Copper and copper alloys	Brass	90	80-225	60-100	0.3	0.03	0.76	0.63	1.0	0.5
40	Bronze and non leaded copper		100	80-255	60-100	0.2	0.03	0.76	0.63	1.0	0.5	
<b>S(M)</b> Heat Resistant Material	19	High temperature alloys	Annealed (Iron based)	200	45-60	25-45	0.2	0.04	0.25	0.22	0.5	0.2
	20		Aged (Iron based)	280	30-50	20-30	0.08	0.03	0.2	0.18	0.4	0.15
	21		Annealed (Nickel or Cobalt based)	250	20-30	15-20	0.08	0.01	0.2	0.18	0.4	0.15
	22		Aged (Nickel or Cobalt based)	350	15-25	10-15	0.05	0.01	0.2	0.18	0.4	0.15
	23	Titanium alloys	Pure 99.5 Ti	400Rm	140-170	60-100	0.05	0.02	0.2	0.18	0.4	0.15
24	α+β alloys		1050Rm	50-70	40-50	0.05	0.02	0.2	0.18	0.4	0.15	
<b>H(K)</b> Hardened Material	25	Extra hard steel	Hardened & tempered	45-50HRc	45-65	20-45	0.02	0.01	0.1	0.05	0.2	0.05
	26			51-55HRc	45-60	20-40	0.01	0.01	0.05	0.05	0.1	0.05

### Grades and Their Applications

**VTX**

General use carbide grade. TiAlN coated.

**VMX**

General use carbide grade for Micro inserts. TiN coated

**VBX**

General use carbide grade for Microscope inserts. TiCN coated



# Milling

## > **Thread Milling**

Standard

MiTM

TMSD

Solid Carbide

## > **Groove Milling**

# MILLING

## Threading

■ A Tool for Every Thread Milling Job.....	Page 195
■ Thread Milling Method.....	Page 196
■ Tooling Recommendation for Given Thread Specification.....	Page 197
■ Thread Milling Inserts.....	Page 208
■ Thread Milling Holders.....	Page 234
■ Thread Milling Technical Data.....	Page 244
■ MiTM Inserts.....	Page 255
■ MiTM Toolholders and Tooling Recommendation.....	Page 260
■ MiTM Technical Data.....	Page 265
■ TMSD Inserts.....	Page 270
■ TMSD Toolholders and Tooling Recommendation.....	Page 271
■ TMSD Technical Data.....	Page 273
■ TM Solid Carbide.....	Page 280
■ TM Solid Carbide Technical Data.....	Page 305

## Grooving

■ Grooving Milling Inserts.....	Page 311
■ Grooving Milling Holders.....	Page 314
■ Grooving Milling Technical Data.....	Page 316

## VARGUS TM Gen Software for CNC Programming

### Thread Milling Software

Using the VARDEX Thread Milling system is simple. Vargus has developed a multi-lingual software for CNC programming. All the operator has to do is enter the basic thread parameters and then follow the computer instructions, which lead the operator to the correct choice of tool for the job on hand. The software will then generate the helical interpolation for the CNC program. It couldn't be simpler!

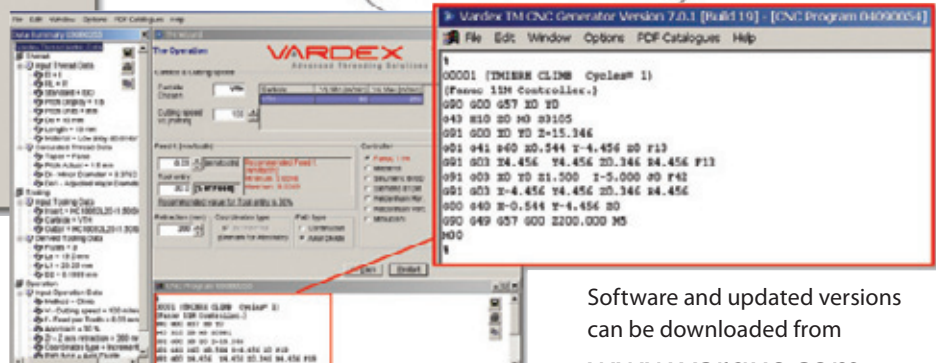

Software and updated versions  
can be downloaded from  
[www.vargus.com](http://www.vargus.com)

# A Tool for EVERY Thread Milling Job!

Regular Threads	Standard Thread  From M15x1.0 (9/16"x32UN)	Conical Thread  From 1/4"x18NPT	Coarse Pitch  From M10x0.75 (7/16"x20UNF)	
	Short Thread  From Pitch 0.35mm (80 TPI)	Long Thread  Up to 98.0mm (3.86")	Extra Long Thread  Up to 144mm (5.7")	Extra Long Thread  Up to 200mm (7.88")
	Fine  From pitch 0.35mm (80 TPI)	Large - Multi Tooth  Up to ISO 6.0 (4UN)	Large - Single Point  Up to ISO 6.0 (4UN)	
Fewer Cycles	Long Inserts  Up to 38.9mm (1.53")	Offset Inserts  Effective length up to 50.8mm (2.0")		
	Small & Medium Diameter  Up to 5 flutes	Medium Diameter  2 flutes	Large Diameter  Up to 9 flutes	Large Diameter  Up to 8 flutes
Small Thread Diameters	Indexable Inserts  From M10x0.75 (7/16"x32UN)	Extremely Small Threads  From M1.0x0.25 (0-80UNF) Up to 62 HRc	Long Thread  From M6x1, Max thread length 63mm (2.362")	
	Normal Use  From M4.5x0.75 (No.8-36UNF)	Heavy Duty  From M3x0.5 (No.10-32UNF)	Radial Coolant  From M6x1.0	
	Helicool+Chamfer  From M6x1.0	Economical Tool  From M3x0.5 (No.8-36UNF)	Drill, Thread and Chamfer  From M6x1.0	

# Thread Milling Methods

## External

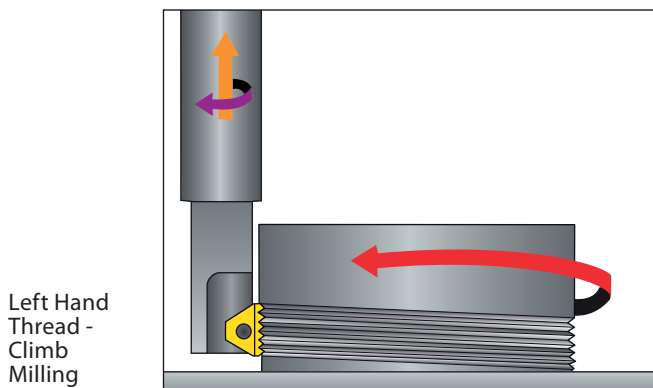
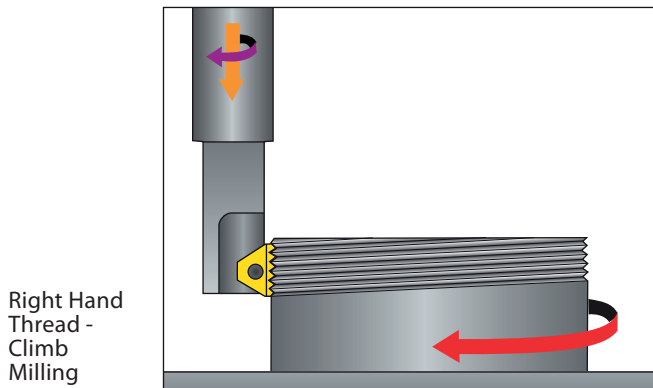
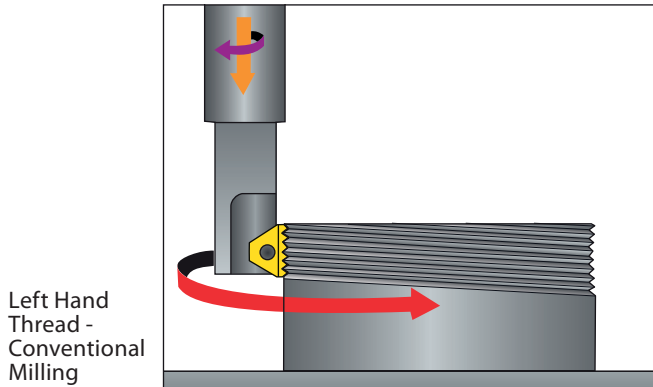
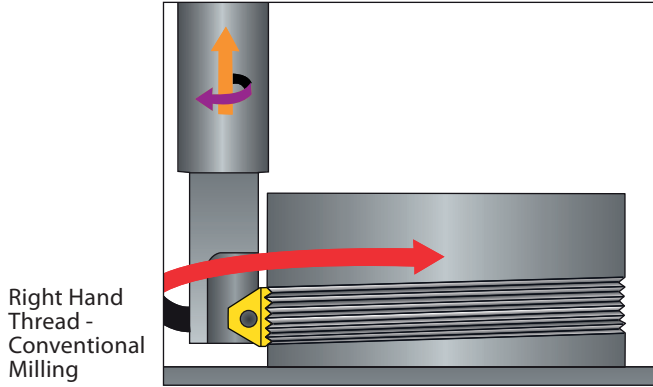

## Internal

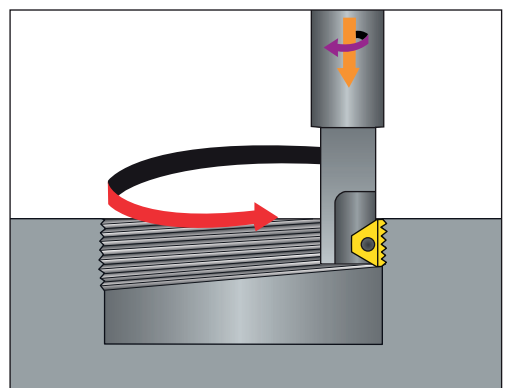
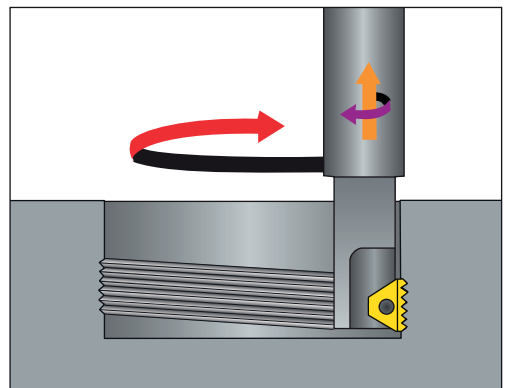
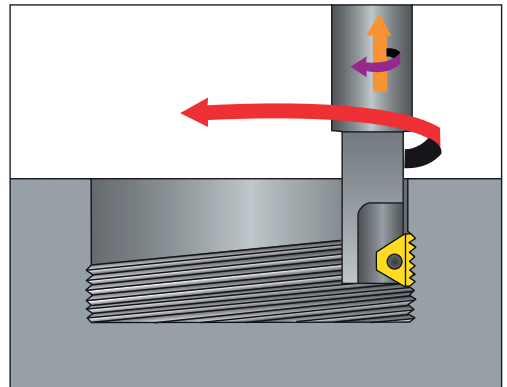
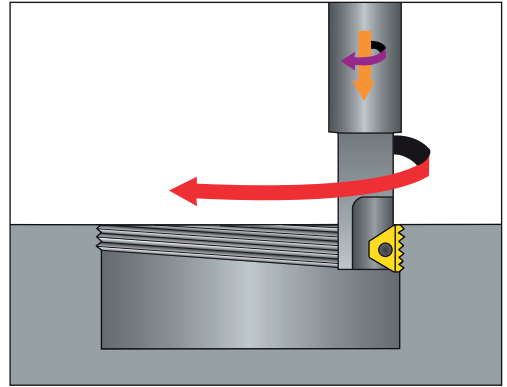

## Tooling recommendation\*

(For MiTM tools see page 254)

(For TMSD tools see page 268)

(For TM Solid Carbide tools see page 278)

TM Gen Software  
and updated versions  
can be downloaded from  
[www.vargus.com](http://www.vargus.com)



### ISO - Internal

Pitch mm	Nominal Dia. mm	Holder	Insert	L1-Toolholder Overhang	D2-Tool Cutting dia.*	hmin. - Thread Profile depth
0.75	10	TMMC12-6.0	6.0I0.75ISOTM...028/001	12.0	9.0	0.43
	11	TMMC12-6.0	6.0I0.75ISOTM...	12.0	9.0	
	12-14	TMMC12-6.0	6.0I1.0ISOTM...	12.0	9.0	
	15-18	TMC12-2	2I1.0ISOTM2...	12.0	11.5	
	20	TMC16-3	3I1.0ISOTM2...	22.0	17.0	
1.0	22	BTMC20-3B	3BI1.0ISOTM2...	29.0	19.0	0.58
	24	TMC20-3	3I1.0ISOTM2...	43.0	20.0	
	25-28	TMLC25-3	3I1.0ISOTM2...	25.0	22.0	
	30	TM2C25-3	3I1.0ISOTM2...	43.0	26.0	
	12	TMMC12-6.0	6.0I1.25ISOTM...028/002	12.0	9.0	
14	TMMC12-6.0	6.0I1.25ISOTM...	12.0	9.0		
14-15	TMMC12-6.0	6.0I1.5ISOTM...	12.0	9.0		
16-20	TMC12-2	2I1.5ISOTM2...	12.0	11.5		
22	TMC16-3	3I1.5ISOTM2...	22.0	17.0		
1.5	24	BTMC20-3B	3BI1.5ISOTM2...	29.0	19.0	0.87
	25-26	TMC20-3	3I1.5ISOTM2...	43.0	20.0	
	27-30	TMLC25-3	3I1.5ISOTM2...	25.0	22.0	
	32-33	TM2C25-3	3I1.5ISOTM2...	43.0	26.0	
	35-42	TMC25-5	5I1.5ISOTM2...	52.0	30.0	
	45	TMC32-5	5I1.5ISOTM2...	58.0	37.0	
	48-55	TM2C32-5	5I1.5ISOTM2...	45.0	42.0	
	56-68	TMSH-D50-22-3	3I1.5ISOTM2...		50.0	
	70-80	TMSH-D63-22-5	5I1.5ISOTM2...		63.0	
	12	TMMC20-6.0 124/003	6.0I1.75ISOTM...028/003	15.0	9.0	
14-20	TMC12-2	2I2.0ISOTM...028/004	12.0	11.5		
22	TMNC16-3	3I2.0ISOTM2...	22.0	15.5		
24	TMC16-3	3I2.0ISOTM2...	22.0	17.0		
25	BTMC20-3B	3BI2.0ISOTM2...	29.0	19.0		
27	TMC20-3	3I2.0ISOTM2...	43.0	20.0		
28-32	TMLC25-3	3I2.0ISOTM2...	25.0	22.0		
33-36	TM2C25-3	3I2.0ISOTM2...	43.0	26.0		
39-42	TMC25-5	5I2.0ISOTM2...	52.0	30.0	1.15	
45-48	TMC32-5	5I2.0ISOTM2...	58.0	37.0		
50-56	TM2C32-5	5I2.0ISOTM2...	45.0	42.0		
58-68	TMSH-D50-22-3	3I2.0ISOTM2...		50.0		
70-85	TMSH-D63-22-5	5I2.0ISOTM2...		63.0		
90-105	TMSH-D80-27-5	5I2.0ISOTM2...		80.0		
110-130	TMSH-D100-32-5	5I2.0ISOTM2...		100.0		
135-150	TMSH-D125-40-5	5I2.0ISOTM2...		125.0		
2.5	20	TMC16-3 124/001	3I2.5ISOTM...028/005	20.5	15.50	1.44
	22	TMC25-4 124/002	4I2.5ISOTM...028/006	30.0	18.0	

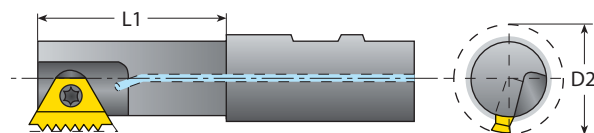

\* The recommended holder is the largest for the given thread specification.  
Holder with smaller or equal cutting diameters (D2) can also be used (Except inserts 028/...).

## Tooling recommendation (con't)\*

(For MiTM tools see page 254)

(For TMSD tools see page 268)

(For TM Solid Carbide tools see page 278)

TM Gen Software  
and updated versions  
can be downloaded from  
[www.vargus.com](http://www.vargus.com)



### ISO - Internal (con't)

Pitch mm	Nominal Dia. mm	Holder	Insert	L1-Toolholder Overhang	D2-Tool Cutting dia.*	hmin. - Thread Profile depth
3.0	24-33	TMC25-4 124/002	4I3.0ISOTM...028/007	30.0	18.0	1.73
	36-40	TMC25-5	5I3.0ISOTM...028/009	52.0	30.0	
	42-48	TMC25-5	5I3.0ISOTM2...	52.0	30.0	
	50-52	TMC32-5	5I3.0ISOTM2...	58.0	37.0	
	55-72	TM2C32-5	5I3.0ISOTM2...	45.0	42.0	
	75-90	TMSH-D63-22-5	5I3.0ISOTM2...		63.0	
	95-110	TMSH-D80-27-5	5I3.0ISOTM2...		80.0	
	115-135	TMSH-D100-32-5	5I3.0ISOTM2...		100.0	
3.5	140-250	TMSH-D125-40-5	5I3.0ISOTM2...		125.0	2.02
	30-33	TMC25-5 124/004	5I3.5ISOTM...028/008	40.0	25.0	
4.0	36-42	TMC25-5	5I4.0ISOTM...028/010	52.0	30.0	2.31
	45-52	TMC25-5	5I4.0ISOTM2...	52.0	30.0	
	55	TMC32-6B	6BI4.0ISOTM2...	55.0	35.0	
	56-58	TMC32-5	5I4.0ISOTM2...	58.0	37.0	
	60-65	TMC40-6B	6BI4.0ISOTM2...	65.0	46.0	
	68-76	TM2C40-6B	6BI4.0ISOTM2...	65.0	52.0	
	80-90	TMSH-D63-22-6B	6BI4.0ISOTM2...		63.0	
	95-110	TMSH-D80-27-6B	6BI4.0ISOTM2...		80.0	
	115-135	TMSH-D100-32-6B	6BI4.0ISOTM2...		100.0	
	140-300	TMSH-D125-40-6B	6BI4.0ISOTM2...		125.0	
4.5	42-45	TMC25-5	5I4.5ISOTM...028/011	52.0	30.0	2.60
5.0	48-52	TMC25-5	5I5.0ISOTM...028/075	52.0	30.0	2.89
		TMC32-6B	6BI5.0ISOTM2...	55.0	35.0	
5.5	56	TMC32-6B	6BI5.5ISOTM2...	55.0	35.0	3.17
	60	TMC40-6B	6BI5.5ISOTM2...	65.0	46.0	
6.0	64-68	TMC40-6B	6BI6.0ISOTM2...	65.0	46.0	3.46
	70-80	TM2C40-6B	6BI6.0ISOTM2...	65.0	52.0	
	85-100	TMSH-D63-22-6B	6BI6.0ISOTM2...		63.0	
	105-120	TMSH-D80-27-6B	6BI6.0ISOTM2...		80.0	
	125-145	TMSH-D100-32-6B	6BI6.0ISOTM2...		100.0	
	150-300	TMSH-D125-40-6B	6BI6.0ISOTM2...		125.0	

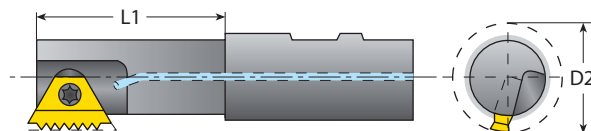

\* The recommended holder is the largest for the given thread specification.  
Holder with smaller or equal cutting diameters (D2) can also be used (Except inserts 028/...).



# Tooling recommendation (con't)\*

(For MiTM tools see page 254)

(For TMSD tools see page 268)

(For TM Solid Carbide tools see page 278)

TM Gen Software  
and updated versions  
can be downloaded from  
[www.vargus.com](http://www.vargus.com)



## UN - Internal

Pitch tpi	Nominal Dia. Inch	Holder	Insert	L1-Toolholder Overhang	D2-Tool Cutting dia.*	hmin. - Thread Profile depth
32	7/16-1/2	TMMC12-6.0	6.0I32UNTM...	12.0	9.0	0.46
	9/16-11/16	TMC12-2	2I32UNTM2...	12.0	11.5	
	3/4-13/16	TMC16-3	3I32UNTM2...	22.0	17.0	
	7/8-15/16	TMC20-3	3I32UNTM2...	43.0	20.0	
28	1	TMLC25-3	3I32UNTM2...	25.0	22.0	0.52
	7/16-1/2	TMMC12-6.0	6.0I28UNTM...	12.0	9.0	
	9/16-3/4	TMC12-2	2I28UNTM2...	12.0	11.5	
	13/16-7/8	TMC16-3	3I28UNTM2...	22.0	17.0	
	15/16	TMC20-3	3I28UNTM2...	43.0	20.0	
24	1-1 1/8	TMLC25-3	3I28UNTM2...	25.0	22.0	0.61
	1 3/16-1 1/2	TM2C25-3	3I28UNTM2...	43.0	26.0	
20	9/16-11/16	TMC12-2	2I24UNTM2...	12.0	11.5	0.73
	7/16	TMMC12-6.0	6.0I20UNTM...028/012	12.0	9.0	
	1/2-9/16	TMMC12-6.0	6.0I20UNTM...	12.0	9.0	
	5/8-13/16	TMC12-2	2I20UNTM2...	12.0	11.5	
	7/8	TMC16-3	3I20UNTM2...	22.0	17.0	
	15/16-1	TMC20-3	3I20UNTM2...	43.0	20.0	
	1 1/16-1 1/8	TMLC25-3	3I20UNTM2...	25.0	22.0	
	1 3/16-1 5/16	TM2C25-3	3I20UNTM2...	43.0	26.0	
	1 3/8-1 5/8	TMC25-5	5I20UNTM2...	52.0	30.0	
	1 11/16-1 13/16	TMC32-5	5I20UNTM2...	58.0	37.0	
18	1 7/8-2 1/8	TM2C32-5	5I20UNTM2...	45.0	42.0	0.81
	2 1/4-2 5/8	TMSH-D50-22-3	3I20UNTM2...		50.0	
	2 3/4-3	TMSH-D63-22-5	5I20UNTM2...		63.0	
	9/16	TMC12-2	2I18UNTM...028/017	12.0	11.5	
	5/8	TMC12-2	2I18UNTM2...	12.0	11.5	
	1 1/16-1 3/16	TMLC25-3	3I18UNTM2...	25.0	22.0	
	1 1/4-1 3/8	TM2C25-3	3I18UNTM2...	43.0	26.0	
	1 7/16-1 5/8	TMC25-5	5I18UNTM2...	52.0	30.0	
16	1 11/16	TMC32-5	5I18UNTM2...	58.0	37.0	0.92
	7/16-5/8	TMMC12-6.0	6.0I16UNTM...028/014	12.0	9.0	
	11/16-13/16	TMC12-2	2I16UNTM2...	12.0	11.5	
	7/8-15/16	TMC16-3	3I16UNTM2...	22.0	17.0	
	1	TMC20-3	3I16UNTM2...	43.0	20.0	
	1 1/16-1 3/16	TMLC25-3	3I16UNTM2...	25.0	22.0	
	1 1/4-1 3/8	TM2C25-3	3I16UNTM2...	43.0	26.0	
	1 7/16-1 5/8	TMC25-5	5I16UNTM2...	52.0	30.0	
	1 11/16-1 7/8	TMC32-5	5I16UNTM2...	58.0	37.0	
	1 15/16-2 3/16	TM2C32-5	5I16UNTM2...	45.0	42.0	
	2 1/4-2 5/8	TMSH-D50-22-3	3I16UNTM2...		50.0	
2 3/4-3 3/8	TMSH-D63-22-5	5I16UN TM2...		63.0		

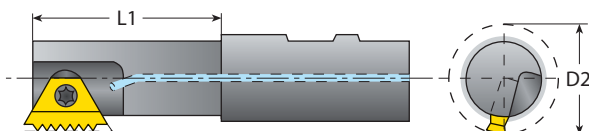

\* The recommended holder is the largest for the given thread specification.  
Holder with smaller or equal cutting diameters (D2) can also be used (Except inserts 028/...).

## Tooling recommendation (con't)\*

(For MiTM tools see page 254)

(For TMSD tools see page 268)

(For TM Solid Carbide tools see page 278)

TM Gen Software  
and updated versions  
can be downloaded from  
[www.vargus.com](http://www.vargus.com)



### UN - Internal (con"t)

Pitch tpi	Nominal Dia. Inch	Holder	Insert	L1-Toolholder Overhang	D2-Tool Cutting dia.*	hmin. - Thread Profile depth
16	3 1/2-4	TMSH-D80-27-5	5I16UNTM2...		80.0	0.92
14	7/16	TMMC20-6.0 124/003	6.0I14UNTM...028/013	15.0	9.0	1.05
	7/8	TMC12-2	2I14UNTM2...	12.0	11.5	
13	1/2	TMC20-2 124/005	2I13UNTM...028/015	15.5	10.0	1.13
	9/16-11/16	TMC20-2 124/005	2I12UNTM...028/016	15.5	10.0	
	3/4	TMNC16-3	3I12UNTM...028/020	22.0	15.5	
	13/16	TMC16-3	3I12UNTM...028/020	22.0	17.0	
	7/8	TMNC16-3	3I12UNTM2...	22.0	15.5	
	15/16	TMC16-3	3I12UNTM2...	22.0	17.0	
	1	BTMC20-3B	3BI12UNTM2...	29.0	19.0	
	1 1/16	TMC20-3	3I12UNTM2...	43.0	20.0	
	1 1/8-1 1/4	TMLC25-3	3I12UNTM2...	25.0	22.0	
	1 5/16-1 7/16	TM2C25-3	3I12UNTM2...	43.0	26.0	
12	1 1/2-1 11/16	TMC25-5	5I12UNTM2...	52.0	30.0	1.22
	1 3/4-1 15/16	TMC32-5	5I12UNTM2...	58.0	37.0	
	2-2 1/4	TM2C32-5	5I12UNTM2...	45.0	42.0	
	2 3/8-2 3/4	TMSH-D50-22-3	3I12UNTM2...		50.0	
	2 7/8-3 3/8	TMSH-D63-22-5	5I12UNTM2...		63.0	
	3 1/2-4	TMSH-D80-27-5	5I12UNTM2...		80.0	
	5/8	TMC20-2 124/006	2I11UNTM...028/018	15.5	12.0	
	3/4	TMC16-3 124/001	3I10UNTM...028/019	20.5	15.5	
	7/8	TMC25-4 124/002	4I9UNTM...028/021	30.0	18.0	
	8	1-1 3/16	TMC25-4 124/007	4I8UNTM...028/022	40.0	
1 1/4-1 3/8		TMC25-5 124/004	5I8UNTM...028/024	40.0	25.0	
1 7/16-1 5/8		TMC25-5	5I8UNTM...028/024	52.0	30.0	
1 11/16-1 15/16		TMC25-5	5I8UNTM2...	52.0	30.0	
2-2 1/8		TMC32-5	5I8UNTM2...	58.0	37.0	
2 1/4-2 7/8		TM2C32-5	5I8UNTM2...	45.0	42.0	
3-3 5/8		TMSH-D63-22-5	5I8UNTM2...		63.0	
3 3/4-4		TMSH-D80-27-5	5I8UNTM2...		80.0	
7	1 1/8-1 1/4	TMC25-4 124/002	4I7UNTM...028/023	30.0	18.0	2.09
	1 3/8-1 9/16	TMC25-5 124/004	5I6UNTM...028/025	40.0	25.0	
	1 5/8-1 15/16	TMC25-5	5I6UNTM...028/025	52.0	30.0	
	2-2 1/8	TMC25-5	5I6UNTM2...	52.0	30.0	
	2 1/4	TMC32-5	5I6UNTM2...	58.0	37.0	
6	2 3/8-2 1/2	TMC40-6B	6BI6UNTM2...	65.0	46.0	2.44
	2 5/8-3 1/8	TM2C40-6B	6BI6UNTM2...	65.0	52.0	
	3 1/4-3 3/4	TMSH-D63-22-6B	6BI6UNTM2...		63.0	
	3 7/8-4	TMSH-D80-27-6B	6BI6UNTM2...		80.0	
	1 3/4	TMC25-5	5I5UNTM...028/077	52.0	30.0	
5	1 3/4	TMC25-5	5I5UNTM...028/077	52.0	30.0	2.93
4.5	2-2 1/4	TMC32-6B	6BI4.5UNTM2...	55.0	35.0	3.26
	2 1/2	TMC40-6B	6BI4UNTM2...	65.0	46.0	
4	2 3/4-3	TM2C40-6B	6BI4UNTM2...	65.0	52.0	3.67
	3 1/4-4	TMSH-D63-22-6B	6BI4UNTM2...		63.0	

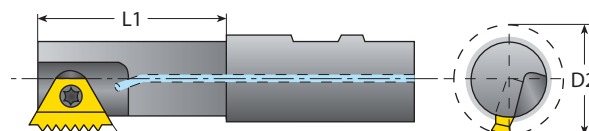

\* The recommended holder is the largest for the given thread specification.  
Holder with smaller or equal cutting diameters (D2) can also be used (Except inserts 028/...).

## Tooling recommendation (con't)\*

(For MiTM tools see page 254)

(For TMSD tools see page 268)

(For TM Solid Carbide tools see page 278)

TM Gen Software  
and updated versions  
can be downloaded from  
[www.vargus.com](http://www.vargus.com)



### UNJ - Internal

Pitch tpi	Nominal Dia. Inch	Holder	Insert	L1-Toolholder Overhang	D2-Tool Cutting dia.*	hmin. - Thread Profile depth
24	9/16-11/16	TMC12-2	2I24UNJTM2...	12.0	11.5	0.55
	1/2	TMMC12-6.0	6.0I20UNJTM...	12.0	9.0	
20	3/4-13/16	TMC12-2	2I20UNJTM2...	12.0	11.5	0.66
	7/8	TMC16-3	3I20UNJTM2...	22.0	17.0	
	15/16-1	TMC20-3	3I20UNJTM2...	43.0	20.0	
18	5/8	TMC12-2	2I18UNJTM2...	12.0	11.5	0.74
	1 1/16-1 3/16	TMLC25-3	3I18UNJTM2...	25.0	22.0	
	1 1/4-1 11/16	TM2C25-3	3I18UNJTM2...	43.0	26.0	
16	11/16-13/16	TMC12-2	2I16UNJTM2...	12.0	11.5	0.83
	7/8-15/16	TMC16-3	3I16UNJTM2...	22.0	17.0	
	1	TMC20-3	3I16UNJTM2...	43.0	20.0	
	1 1/16-1 3/16	TMLC25-3	3I16UNJTM2...	25.0	22.0	
	1 1/4-1 3/8	TM2C25-3	3I16UNJTM2...	43.0	26.0	
	1 7/16-1 5/8	TMC25-5	5I16UNJTM2...	52.0	30.0	
	1 11/16-1 7/8	TMC32-5	5I16UNJTM2...	58.0	37.0	
	1 15/16-2 1/8	TM2C32-5	5I16UNJTM2...	45.0	42.0	
14	2 1/4-2 3/8	TMSH-D50-22-3	3I16UNJTM2...		50.0	0.95
	7/8	TMC12-2	2I14UNJTM2...	12.0	11.5	
12	7/8	TMNC16-3	3I12UNJTM2...	22.0	15.5	1.11
	15/16-1	TMC16-3	3I12UNJTM2...	22.0	17.0	
	1 1/16	TMC20-3	3I12UNJTM2...	43.0	20.0	
	1 1/8-1 1/4	TMLC25-3	3I12UNJTM2...	25.0	22.0	
	1 5/16-1 7/16	TM2C25-3	3I12UNJTM2...	43.0	26.0	
	1 1/2-1 11/16	TMC25-5	5I12UNJTM2...	52.0	30.0	
	1 3/4-1 15/16	TMC32-5	5I12UNJTM2...	58.0	37.0	
	2-2 1/4	TM2C32-5	5I12UNJTM2...	45.0	42.0	
12	2 3/8-2 3/4	TMSH-D50-22-3	3I12UNJTM2...		50.0	1.11
	2 7/8-3 3/8	TMSH-D63-22-5	5I12UNJTM2...		63.0	
	3 1/2-4 1/4	TMSH-D80-27-5	5I12UNJTM2...		80.0	
	4 3/8-5 1/4	TMSH-D100-32-5	5I12UNJTM2...		100.0	
	5 3/8-6	TMSH-D125-40-5	5I12UNJTM2...		125.0	

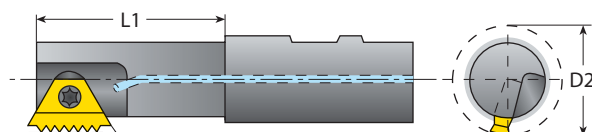

\* The recommended holder is the largest for the given thread specification.  
Holder with smaller or equal cutting diameters (D2) can also be used (Except inserts 028/...).

## Tooling recommendation (con't)\*

(For MiTM tools see page 254)

(For TMSD tools see page 268)

(For TM Solid Carbide tools see page 278)

TM Gen Software  
and updated versions  
can be downloaded from  
[www.vargus.com](http://www.vargus.com)



### W - Internal

Pitch tpi	Nominal Dia. Inch	Holder	Insert	L1-Toolholder Overhang	D2-Tool Cutting dia.*	hmin. - Thread Profile depth
26	7/16	TMMC12-6.0	6.0I26WTM...028/036	12.0	9.0	0.63
	1/2-9/16	TMMC12-6.0	6.0EI26WTM...	12.0	9.0	
	5/8-3/4	TMC12-2	2EI26WTM2...	12.0	11.5	
	13/16-7/8	TMC16-3	3EI26WTM2...	22.0	17.0	
	15/16-1	TMC20-3	3EI26WTM2...	43.0	20.0	
	1 1/16-1 1/8	TMLC25-3	3EI26WTM2...	25.0	22.0	
	1 3/16-1 5/8	TM2C25-3	3EI26WTM2...	43.0	26.0	
	1 3/4-2	TMSH-D38-16-2	2EI26WTM2...		38.0	
20	1/2	TMMC12-6.0	6.0I20WTM...028/037	12.0	9.0	0.81
	9/16	TMMC12-6.0	6.0EI20WTM2...	12.0	9.0	
	5/8-13/16	TMC12-2	2EI20WTM2...	12.0	11.5	
	7/8-15/16	TMC16-3	3EI20WTM2...	22.0	17.0	
	1	TMC20-3	3EI20WTM2...	43.0	20.0	
	1 1/16-1 3/16	TMLC25-3	3EI20WTM2...	25.0	22.0	
	1 1/4-1 5/8	TM2C25-3	3EI20WTM2...	43.0	26.0	
	1 3/4-2 1/8	TMSH-D38-16-2	2EI20WTM2...		38.0	
18	2 1/4-3	TMSH-D50-22-3	3EI20WTM2...		50.0	0.90
	7/16	TMMC12-6.0	6.0I18WTM...028/035	12.0	9.0	
	1/2	TMC20-2 124/005	2I16WTM...028/051	15.5	10.0	
	9/16-3/4	TMC12-2	2I16WTM...028/038	12.0	11.5	
	13/16	TMNC16-3	3EI16WTM2...	22.0	15.5	
	7/8-15/16	TMC16-3	3EI16WTM2...	22.0	17.0	
	1-1 1/16	TMC20-3	3EI16WTM2...	43.0	20.0	
	1 1/8-1 1/4	TMLC25-3	3EI16WTM2...	25.0	22.0	
	1 5/16-1 3/8	TM2C25-3	3EI16WTM2...	43.0	26.0	
	1.4-1 5/8	TMC25-5	5EI16WTM2...	52.0	30.0	
	1 3/4-1.9	TMC32-5	5EI16WTM2...	58.0	37.0	
	2-2 1/4	TM2C32-5	5EI16WTM2...	45.0	42.0	
	2 3/8-2 3/4	TMSH-D50-22-3	3EI16WTM2...		50.0	
	2 7/8-3 3/8	TMSH-D63-22-5	5EI16WTM2...		63.0	
	3 1/2-4 1/8	TMSH-D80-27-5	5EI16WTM2...		80.0	
	4 1/4-5 1/8	TMSH-D100-32-5	5EI16WTM2...		100.0	
16	5 1/4-7	TMSH-D125-40-5	5EI16WTM2...		125.0	1.02
	5/8-11/16	TMC20-2 124/006	2I14WTM...028/039	15.5	12.0	
	3/4	TMC16-3 124/001	3I12WTM...028/040	20.5	15.5	
	13/16	TMC16-3	3I12WTM...028/041	22.0	17.0	
	15/16-1 5/16	TMC20-3	3I12WTM...028/041	43.0	20.0	
	1 3/8-1 7/16	TMC25-5	5I12WTM...028/050	52.0	30.0	
	1 1/2-1 3/4	TMC25-5	5EI12WTM2...	52.0	30.0	
	1 7/8	TMC32-5	5EI12WTM2...	58.0	37.0	
	2-2 1/4	TM2C32-5	5EI12WTM2...	45.0	42.0	
	14	12				
12						
12						
12						
12						
12						

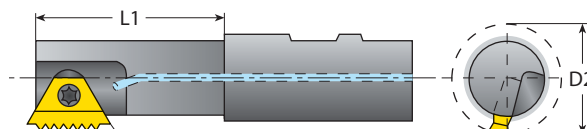

\* The recommended holder is the largest for the given thread specification.  
Holder with smaller or equal cutting diameters (D2) can also be used (Except inserts 028/...).

## Tooling recommendation (con't)\*

(For MiTM tools see page 254)

(For TMSD tools see page 268)

(For TM Solid Carbide tools see page 278)

TM Gen Software  
and updated versions  
can be downloaded from  
[www.vargus.com](http://www.vargus.com)



### W - Internal (con't)

Pitch tpi	Nominal Dia. Inch	Holder	Insert	L1-Toolholder Overhang	D2-Tool Cutting dia.*	hmin. - Thread Profile depth
12	2 3/8 -2 3/4	TMSH-D50-22-3	3E12WTM2...		50.0	1.36
	2 7/8-3 3/8	TMSH-D63-22-5	5E12WTM2...		63.0	
	3 1/2-4 1/8	TMSH-D80-27-5	5E12WTM2...		80.0	
	4 1/4-5 1/8	TMSH-D100-32-5	5E12WTM2...		100.0	
	5 1/4-7	TMSH-D125-40-5	5E12WTM2...		125.0	
11	7/8	TMC25-4 124/002	4I11WTM...028/043	30.0	18.0	1.48
10	1	TMC25-4 124/002	4I10WTM...028/045	30.0	18.0	1.63
9	7/8-1 1/4	TMC25-4 124/002	4I9WTM...028/042	30.0	18.0	1.81
	1	TMC25-4 124/002	4I8WTM...028/044	30.0	18.0	
8	1 3/16-1.4	TMC25-5 124/004	5I8WTM...028/047	40.0	25.0	2.03
	1 7/16-1 5/8	TMC25-5	5I8WTM...028/047	52.0	30.0	
	1 7/8-1.9	TMC25-5	5E18WTM2...	52.0	30.0	
	2.1-2 1/8	TMC32-5	5E18WTM2...	58.0	37.0	
	2 1/4-3	TM2C32-5	5E18WTM2...	45.0	42.0	
	3 1/8-3 5/8	TMSH-D63-22-5	5E18WTM2...		63.0	
	3 3/4-4 3/8	TMSH-D80-27-5	5E18WTM2...		80.0	
	4 5/8-5 1/2	TMSH-D100-32-5	5E18WTM2...		100.0	
	5 5/8-7	TMSH-D125-40-5	5E18WTM2...		125.0	
	7	1 1/8	TMC25-5 124/008	5I7WTM...028/046	40.0	
1 1/4		TMC25-5 124/004	5I7WTM...028/048	40.0	25.0	
1 3/4		TMC25-5	5I7WTM...028/048	52.0	30.0	
2		TMC25-5	5E17WTM2...	52.0	30.0	
6	1 5/16-1 1/2	TMC25-5 124/004	5I6WTM...028/049	40.0	25.0	2.71
	1.6-1 5/8	TMC25-5	5I6WTM...028/049	52.0	30.0	
	1 7/8-1.9	TMC32-5	5I6WTM...028/049	58.0	37.0	
	2.1-2 1/8	TMC25-5	5E16WTM2...	52.0	30.0	
	2 1/4	TMC32-6B	6BE16WTM2...	55.0	35.0	
	2 3/8-2.6	TMC32-5	5E16WTM2...	58.0	37.0	
	2 5/8-2 3/4	TMC40-6B	6BE16WTM2...	65.0	46.0	
	2 7/8-3 1/4	TM2C40-6B	6BE16WTM2...	65.0	52.0	
	3 3/8-3 7/8	TMSH-D63-22-6B	6BE16WTM2...		63.0	
	4-4 3/4	TMSH-D80-27-6B	6BE16WTM2...		80.0	
5	4 7/8-5 3/4	TMSH-D100-32-6B	6BE16WTM2...		100.0	3.25
	5 7/8-7	TMSH-D125-40-6B	6BE16WTM2...		125.0	
	3	TMC40-6B	6BE15WTM2...	65.0	46.0	
	3 1/4	TM2C40-6B	6BE15WTM2...	65.0	52.0	
4.5	3 1/2	TMC40-6B	6BE14.5WTM2...	65.0	46.0	3.61
	3 3/4-4	TM2C40-6B	6BE14.5WTM2...	65.0	52.0	

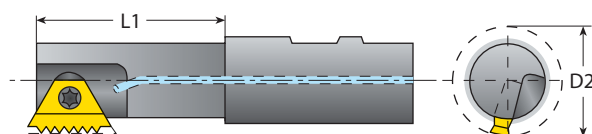

\* The recommended holder is the largest for the given thread specification.  
Holder with smaller or equal cutting diameters (D2) can also be used (Except inserts 028/...).

## Tooling recommendation (con't)\*

(For MiTM tools see page 254)

(For TMSD tools see page 268)

(For TM Solid Carbide tools see page 278)

TM Gen Software  
and updated versions  
can be downloaded from  
[www.vargus.com](http://www.vargus.com)



### BSP - Internal

Pitch tpi	Nominal Dia. Inch	Holder	Insert	L1-Toolholder Overhang	D2-Tool Cutting dia.*	hmin. - Thread Profile depth
19	1/4	TMMC20-6.0	6.0EI19WTM...	17.0	9.0	0.86
	3/8	TMC20-2	2EI19WTM2...	20.0	11.5	
14	1/2-5/8	TMC20-2	2EI14WTM2...	20.0	11.5	1.16
	3/4-7/8	TMC16-3	3EI14WTM2...	22.0	17.0	
11	1	TMC25-5 124/004	5EI11WTM2...	40.0	25.0	1.48
	1 1/4-1 1/2	TMC25-5	5EI11WTM2...	52.0	30.0	
	1 3/4	TMC32-5	5EI11WTM2...	58.0	37.0	
	2-2 1/4	TM2C32-5	5EI11WTM2...	45.0	42.0	
	2 1/2-3	TMSH-D63-22-5	5EI11WTM2...		63.0	
	3 1/2	TMSH-D80-27-5	5EI11WTM2...		80.0	
	4	TMSH-D100-32-5	5EI11WTM2...		100.0	
5-6	TMSH-D125-40-5	5EI11WTM2...		125.0		

### BSPT - Internal

Pitch tpi	Nominal Dia. Inch	Holder	Insert	L1-Toolholder Overhang	D2-Tool Cutting dia.*	hmin. - Thread Profile depth
19	3/8	TMC20-2	2EI19BSPTTM...	20.0	11.5	0.86
14	1/2-3/4	TMNC16-3	3EI14BSPTTM...	22.0	15.5	1.16
	1-1 1/4	TMNC20-3	3EI11BSPTTM...	23.0	19.0	
11	1 1/2	TMC25-5	5EI11BSPTTM...	52.0	30.0	1.48
	2-6	TMNC32-5	5EI11BSPTTM...	58.0	37.0	

### NPT - Internal

Pitch tpi	Nominal Dia. Inch	Holder	Insert	L1-Toolholder Overhang	D2-Tool Cutting dia.*	hmin. - Thread Profile depth
18	1/4-3/8	TMC20-2 124/009	2I18NPTTM...028/074	15.5	10.0	1.01
14	1/2	TMNC16-3	3EI14NPTTM...	22.0	15.5	1.33
	3/4	TMNC20-3	3EI14NPTTM...	23.0	19.0	
11.5	1	TMNC20-3	3EI11.5NPTTM...	23.0	19.0	1.64
	1 1/4	TMC25-5	5EI11.5NPTTM...	52.0	30.0	
	1 1/2-2	TMNC32-5	5EI11.5NPTTM...	58.0	37.0	
8	2 1/2	TMNC32-5	5EI8NPTTM...	58.0	37.0	2.42
	3-24	TMC40-6B	6BEI8NPTTM...	65.0	46.0	

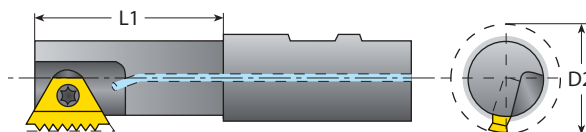

\* The recommended holder is the largest for the given thread specification.  
Holder with smaller or equal cutting diameters (D2) can also be used (Except inserts 028/...).

## Tooling recommendation (con't)\*

(For MiTM tools see page 254)

(For TMSD tools see page 268)

(For TM Solid Carbide tools see page 278)

TM Gen Software  
and updated versions  
can be downloaded from  
[www.vargus.com](http://www.vargus.com)



### NPTF - Internal

Pitch	Nominal Dia.	Holder	Insert	L1-Toolholder	D2-Tool	hmin. - Thread
tpi	Inch			Overhang	Cutting dia.*	Profile depth
18	1/4-3/8	TMC20-2 124/009	2I18NPTFTM...028/078	15.5	10.0	1.00
14	1/2	TMNC16-3	3EI14NPTFTM...	22.0	15.5	1.35
	3/4	TMNC20-3	3EI14NPTFTM...	23.0	19.0	
11.5	1	TMNC20-3	3EI11.5NPTFTM...	23.0	19.0	1.63
	1 1/4	TMC25-5 124/004	5EI11.5NPTFTM...	40.0	25.0	
	1 1/2	TMC25-5	5EI11.5NPTFTM...	52.0	30.0	
	2	TMNC32-5	5EI11.5NPTFTM...	58.0	37.0	
8	2 1/2	TMNC32-5	5EI8NPTFTM...	58.0	37.0	2.38
	3	TMC40-6B	6BEI8NPTFTM...	65.0	46.0	

### PG - Internal

Pitch	Nominal Dia.	Holder	Insert	L1-Toolholder	D2-Tool	hmin. - Thread
tpi	Inch			Overhang	Cutting dia.*	Profile depth
20	PG7	TMMC12-6.0	6.0EI20PGTM...	12.0	9.0	0.61
18	PG9	TMC12-2	2EI18PGTM2...	12.0	11.5	0.67
	PG11	TMNC16-3	3EI18PGTM2...	22.0	15.5	
	PG13.5	TMC16-3	3EI18PGTM2...	22.0	17.0	
	PG16	TMC20-3	3EI18PGTM2...	43.0	20.0	
16	PG21	TMC25-5 124/004	5EI16PGTM2...	40.0	25.0	0.76
	PG29	TMC25-5	5EI16PGTM2...	52.0	30.0	
	PG36	TM2C32-5	5EI16PGTM2...	45.0	42.0	
	PG42-PG48	TMSH-D50-22-3	3EI16PGTM2...		50.0	

### TR -Internal

Pitch	Nominal Dia.	Holder	Insert	L1-Toolholder	D2-Tool	hmin. - Thread
mm	Inch			Overhang	Cutting dia.*	Profile depth
2.0	TR16	TMC20-2 124/006	2I2.0TRTM...028/028	15.5	12.0	1.25
	TR18-TR20	TMC20-2 124/006	2I2.0TRTM...028/029	15.5	12.0	
	TR24	TMC25-4 124/002	4I3.0TRTM...028/030	30.0	18.0	
3.0	TR26-TR30	TMC25-4 124/002	4I3.0TRTM...028/031	30.0	18.0	1.75
	TR32-TR36	TMC25-4 124/007	4I3.0TRTM...028/032	40.0	20.0	
	TR38-TR42	TMC25-5 124/004	5I3.0TRTM...028/033	40.0	25.0	
	TR44-TR48	TMC25-5	5I3.0TRTM...028/033	52.0	30.0	
	TR50-TR60	TMC32-5	5I3.0TRTM...028/033	58.0	37.0	
4.0	TR65-TR110	TMC32-5	5I4.0TRTM...028/034	58.0	37.0	2.25

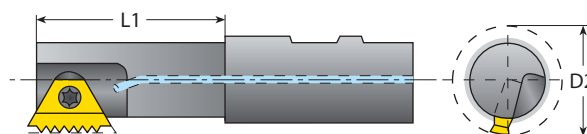

\* The recommended holder is the largest for the given thread specification.  
Holder with smaller or equal cutting diameters (D2) can also be used (Except inserts 028/...).

## Tooling recommendation (con't)\*

(For MiTM tools see page 254)

(For TMSD tools see page 268)

(For TM Solid Carbide tools see page 278)

TM Gen Software  
and updated versions  
can be downloaded from  
[www.vargus.com](http://www.vargus.com)



### ACME - Internal

Pitch tpi	Nominal Dia. Inch	Holder	Insert	L1-Toolholder Overhang	D2-Tool Cutting dia.*	hmin. - Thread Profile depth
16	1/2	TMMC12-6.0	6.0I16ACMETM...028/052	12.0	9.0	0.92
	5/8	TMC12-2	2I16ACMETM...028/053	12.0	11.5	
	3/4	TMC12-2	2I16ACMETM...028/055	12.0	11.5	
14	5/8	TMC20-2 124/005	2I14ACMETM...028/054	15.5	10.0	1.03
	3/4	TMC20-2 124/006	2I14ACMETM...028/083	15.5	12.0	
	7/8	TMNC16-3	3I14ACMETM...028/057	22.0	15.5	
	1	TMC16-3	3I14ACMETM...028/059	22.0	17.0	
12	3/4	TMC20-2 124/006	2I12ACMETM...028/056	15.5	12.0	1.19
	7/8	TMC20-2 124/006	2I12ACMETM...028/058	15.5	12.0	
	1	TMNC16-3	3I12ACMETM...028/060	22.0	15.5	
	1 1/8	TMC16-3	3I12ACMETM...028/060	22.0	17.0	
10	1 1/4	TMC20-3	3I12ACMETM...028/060	43.0	20.0	1.52
	1	TMC25-4 124/002	4I10ACMETM...028/061	30.0	18.0	
	1 1/8	TMC25-4 124/007	4I10ACMETM...028/084	40.0	20.0	
	1 1/4	TMC25-5 124/004	5I10ACMETM...028/064	40.0	25.0	
	1 3/8	TMC25-5 124/004	5I10ACMETM...028/065	40.0	25.0	
8	1 1/2	TMC25-5	5I10ACMETM...028/068	52.0	30.0	1.84
	1 3/4	TMC32-5	5I10ACMETM...028/064	58.0	37.0	
	1	TMC25-4 124/002	4I8ACMETM...028/062	30.0	18.0	
	1 1/8-1 1/4	TMC25-4 124/002	4I8ACMETM...028/063	30.0	18.0	
	1 3/8	TMC25-5 124/004	5I8ACMETM...028/066	40.0	25.0	
	1 1/2	TMC25-5 124/004	5I8ACMETM...028/069	40.0	25.0	
6	1 3/4	TMC25-5	5I8ACMETM...028/069	52.0	30.0	2.37
	2	TMC32-5	5I8ACMETM...028/069	58.0	37.0	
	1 3/8	TMC25-5 124/008	5I6ACMETM...028/067	40.0	22.0	
	1 1/2	TMC25-5 124/004	5I6ACMETM...028/070	40.0	25.0	
	1 3/4	TMC25-5	5I6ACMETM...028/070	52.0	30.0	
5	2	TMC25-5	5I6ACMETM...028/072	52.0	30.0	2.79
	2 1/4	TMC32-5	5I6ACMETM...028/072	58.0	37.0	
	1 3/4	TMC25-5 124/004	5I5ACMETM...028/071	40.0	25.0	
	2	TMC25-5	5I5ACMETM...028/071	52.0	30.0	
5	2 1/4	TMC25-5	5I5ACMETM...028/073	52.0	30.0	2.79
	2 1/2	TMC32-5	5I5ACMETM...028/073	58.0	37.0	

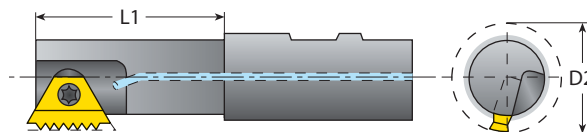

\* The recommended holder is the largest for the given thread specification.  
Holder with smaller or equal cutting diameters (D2) can also be used (Except inserts 028/...).



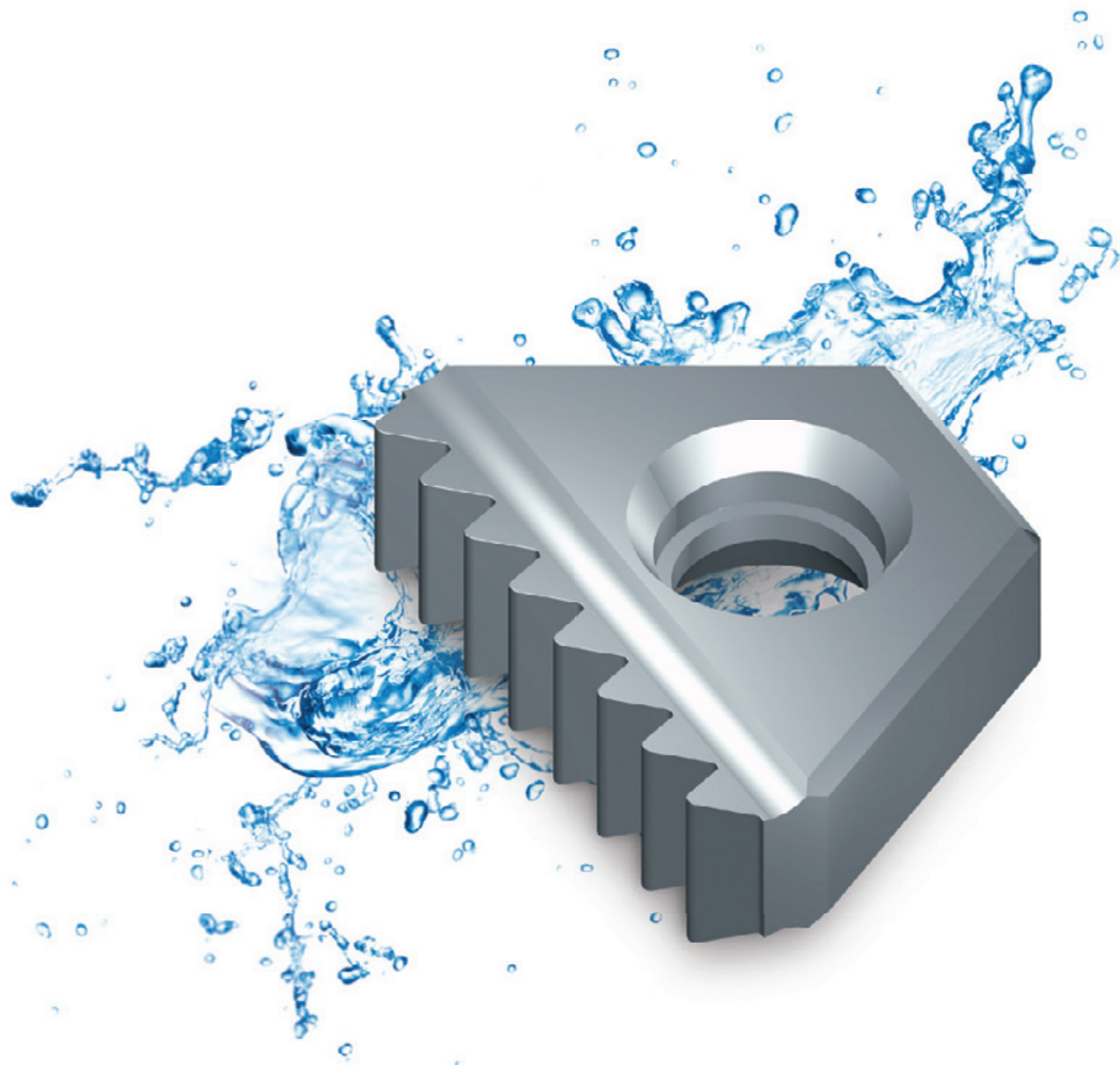

# Thread Milling



> Standard Inserts

# THREAD MILLING INSERTS

■ VARDEX Ordering Code System.....	Page 208
■ ISO Metric Standard TM Inserts.....	Page 209
■ ISO Metric (Internal) Coarse Pitch TM Inserts.....	Page 211
■ ISO Metric Standard TM Inserts for TMO Toolholders.....	Page 212
■ ISO Metric Fine Pitch TM Inserts.....	Page 213
■ American UN Standard TM Inserts.....	Page 214
■ American UN (Internal) Coarse Pitch TM Inserts.....	Page 216
■ American UN Standard TM Inserts for TMO Toolholders.....	Page 218
■ American UN Fine Pitch TM Inserts.....	Page 220
■ UNJ Standard TM Insert.....	Page 221
■ W for BSW, BSP Standard TM Inserts.....	Page 222
■ W for BSW only Coarse Pitch TM Inserts.....	Page 223
■ W for BSW, BSP Standard TM Inserts For TMO Toolholders.....	Page 225
■ NPT Standard TM Inserts.....	Page 226
■ NPT (Internal) Coarse Pitch TM Inserts.....	Page 226
■ NPTF (Dry Seal) Standard TM Inserts.....	Page 227
■ NPTF (Dry Seal-Internal) Coarse Pitch TM Inserts.....	Page 227
■ NPS Standard TM Inserts.....	Page 228
■ BSPT Standard TM Inserts.....	Page 228
■ Pg Standard TM Inserts.....	Page 229
■ ACME (Internal) Coarse Pitch TM Inserts.....	Page 230
■ TR (Internal) Coarse Pitch TM Inserts.....	Page 231

## VarDEX Ordering Code System

### Thread Milling Inserts

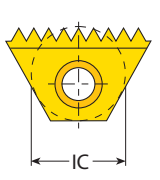
3	B	I	1.5	ISO	TM2	F	VBX	028/...
1	2	3	4	5	6	7	8	9
<b>1 - Insert Size</b> 6.0 - 6.0 mm 2 - 1/4" 3 - 3/8" 3B - 3/8"B 4 - 1/2" 5 - 5/8" 6B - 3/4"B 			<b>2 - Cutting Edge Length</b> B - TMB		<b>3 - Type of Insert</b> E - External I - Internal EI - External + Internal		<b>4 - Pitch</b> 0.35 - 6.0	
<b>5 - Standard</b> ISO- ISO Metric UN- American UN UNJ- UNJ W- Whitworth for BSW, BSP NPT - NPT NPTF- NPTF NPS- NPS BSPT- British Standard Pipe Thread PG- Pg DIN 40430 ACME- ACME TR- Trapez DIN 103					<b>6 - System</b> TM2 TM		<b>8 - Carbide grade</b> VBX VTX VK2	
						<b>7 - Pitch Type</b> F = Fine Pitch	<b>9 - Coarse Pitch Inserts</b> 028/...	

# ISO Metric

## External / Internal

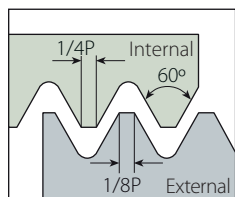

Defined by: R262 (DIN 13)  
Tolerance class: 6g/6H

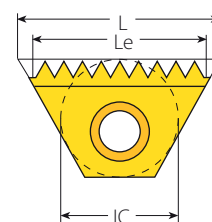

Standard TM

## Standard TM

Insert Size		Pitch	Ordering Code		Le	Teeth	Toolholder
IC	L mm	mm	External	Internal	mm		
6.0mm	10.4	0.5		6.0I0.5ISOTM...	10.0	20	TMMC...-6.0
		0.75		6.0I0.75ISOTM...	9.75	13	
		1.0		6.0I1.0ISOTM...	9.0	9	
		1.25		6.0I1.25ISOTM...	8.75	7	
		1.5		6.0I1.5ISOTM...	9.0	6	
1/4"	11	0.5		2I0.5ISOTM2...	10.0	20	TMC...-2 TMSH...-2
		0.75	2E0.75ISOTM2...	2I0.75ISOTM2...	10.5	14	
		1.0	2E1.0ISOTM2...	2I1.0ISOTM2...	10.0	10	
		1.25	2E1.25ISOTM2...		10.0	8	
		1.25		2I1.25ISOTM2...	8.75	7	
		1.5	2E1.5ISOTM2...		9.0	6	
3/8"	16	0.5		3I0.5ISOTM2...	15.0	30	TMC...-3 TMSH...-3
		0.75	3E0.75ISOTM2...	3I0.75ISOTM2...	15.0	20	
		0.8		3I0.8ISOTM2...	14.4	18	
		1.0	3E1.0ISOTM2...		14.0	14	
		1.0		3I1.0ISOTM2...	15.0	15	
		1.25	3E1.25ISOTM2...	3I1.25ISOTM2...	15.0	12	
		1.5	3E1.5ISOTM2...	3I1.5ISOTM2...	15.0	10	
		1.75	3E1.75ISOTM2...	3I1.75ISOTM2...	14.0	8	
3/8"B	22	1.0	3BE1.0ISOTM2...	3BI1.0ISOTM2...	22.0	22	BTMC...-3B TMSH...-3B
		1.25	3BE1.25ISOTM2...	3BI1.25ISOTM2...	21.25	17	
		1.5	3BE1.5ISOTM2...	3BI1.5ISOTM2...	21.0	14	
		1.75	3BE1.75ISOTM2...	3BI1.75ISOTM2...	21.0	12	
		2.0	3BE2.0ISOTM2...	3BI2.0ISOTM2...	22.0	11	
5/8"	27	1.0	5E1.0ISOTM2...	5I1.0ISOTM2...	26.0	26	TMC...-5 TMSH...-5
		1.25	5E1.25ISOTM2...	5I1.25ISOTM2...	25.0	20	
		1.5	5E1.5ISOTM2...	5I1.5ISOTM2...	25.5	17	
		1.75	5E1.75ISOTM2...	5I1.75ISOTM2...	24.5	14	
		2.0	5E2.0ISOTM2...	5I2.0ISOTM2...	24.0	12	
		2.5	5E2.5ISOTM2...	5I2.5ISOTM2...	25.0	10	
		3.0	5E3.0ISOTM2...	5I3.0ISOTM2...	24.0	8	
		3.5	5E3.5ISOTM2...	5I3.5ISOTM2...	24.5	7	
		4.0	5E4.0ISOTM2...	5I4.0ISOTM2...	24.0	6	
	4.5	5E4.5ISOTM2...	5I4.5ISOTM2...	22.5	5		

continued on next page ►

## ISO Metric (con't)

### External / Internal

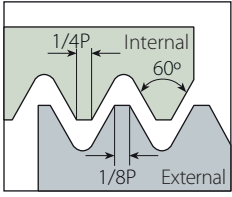

Defined by: R262 (DIN 13)  
Tolerance class: 6g/6H

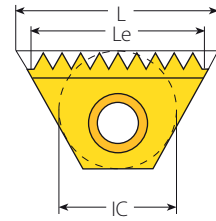

Standard TM

### Standard TM (con't)

Insert Size		Pitch		Ordering Code		Le	Teeth	Toolholder
IC	L mm	mm	External	Internal	mm			
3/4"B	38.5	1.5	6BE1.5ISOTM2...	6BI1.5ISOTM2...	36.0	24	TMC..-6B TMSH..-6B	
		2.0	6BE2.0ISOTM2...	6BI2.0ISOTM2...	36.0	18		
		2.5	6BE2.5ISOTM2...	6BI2.5ISOTM2...	35.0	14		
		3.0	6BE3.0ISOTM2...	6BI3.0ISOTM2...	36.0	12		
		4.0	6BE4.0ISOTM2...	6BI4.0ISOTM2...	32.0	8		
		4.5	6BE4.5ISOTM2...	6BI4.5ISOTM2...	31.5	7		
		5.0	6BE5.0ISOTM2...	6BI5.0ISOTM2...	30.0	6		
		5.5	6BE5.5ISOTM2...	6BI5.5ISOTM2...	33.0	6		
		6.0	6BE6.0ISOTM2...	6BI6.0ISOTM2...	30.0	5		

Sample order: **5I2.0ISOTM2 VBX**

All inserts have 2 cutting edges, except **MiniTM (IC 6.0 mm)** which has one cutting edge.

For toolholder information, see page 234.

## ISO Metric (con't)

### Internal

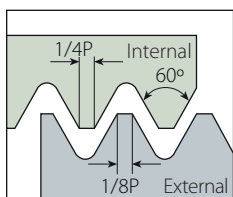

Defined by: R262 (DIN 13)  
 Tolerance class: 6g/6H

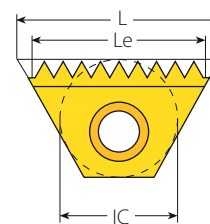

Coarse Pitch TM

### Coarse Pitch TM

Thread	Insert Size		Ordering Code	Cutting Edge	Le	Teeth	Toolholder	Bore Dia. Range
	IC	L mm						
M10 X 0.75	6.0 mm	10.4	6.0I0.75ISOTM...028/001	1	9.75	13	TMMC12-6.0	9.1-10
M10 X 0.75	6.0 mm	10.4	6.0I0.75ISOTM...028/001	1	9.75	13	TMMC20-6.0	9.1-10
M12 X 1.25	6.0 mm	10.4	6.0I1.25ISOTM...028/002	1	8.75	7	TMMC12-6.0	10.6-11.4
M12 X 1.25	6.0 mm	10.4	6.0I1.25ISOTM...028/002	1	8.75	7	TMMC20-6.0	10.6-11.4
M12 X 1.75	6.0 mm	10.4	6.0I1.75ISOTM...028/003	1	8.75	5	TMMC20-6.0 124/003	10.1-19
M14 X 2.0	1/4"	11	2I2.0ISOTM...028/004	2	10.0	5	TMC12-2	11.8-19.5
M14 x 2.0	1/4"	11	2I2.0ISOTM...028/004	2	10.0	5	TMC20-2	11.8-19.5
M16 X 2.0	1/4"	11	2I2.0ISOTM...028/004	2	10.0	5	TMC12-2	11.8-19.5
M16 X 2.0	1/4"	11	2I2.0ISOTM...028/004	2	10.0	5	TMC20-2	11.8-19.5
M20 X 2.5	3/8"	16	3I2.5ISOTM...028/005	1	12.5	5	TMC16-3 124/001	17.2-19.2
M22 X 2.5	1/2"	22	4I2.5ISOTM...028/006	1	17.5	7	TMC25-4 124/002	19.2-31.6
M24 X 3.0	1/2"	22	4I3.0ISOTM...028/007	1	18.0	6	TMC25-4 124/002	20.7-32.7
M27 X 3.0	1/2"	22	4I3.0ISOTM...028/007	1	18.0	6	TMC25-4 124/002	20.7-32.7
M30 X 3.5	5/8"	27	5I3.5ISOTM...028/008	2	24.5	7	TMC25-5 124/004	26.2-35.9
M33 X 3.5	5/8"	27	5I3.5ISOTM...028/008	2	24.5	7	TMC25-5 124/004	26.2-35.9
M36 X 3.0	5/8"	27	5I3.0ISOTM...028/009	2	24.0	8	TMC25-5	32.7-39
M36 X 4.0	5/8"	27	5I4.0ISOTM...028/010	2	24.0	6	TMC25-5	31.6-38.5
M39 X 3.0	5/8"	27	5I3.0ISOTM...028/009	2	24.0	8	TMC25-5	32.7-39
M39 X 4.0	5/8"	27	5I4.0ISOTM...028/010	2	24.0	6	TMC25-5	31.6-38.5
M42 X 4.5	5/8"	27	5I4.5ISOTM...028/011	2	22.5	5	TMC25-5	37.1-48
M45 X 4.5	5/8"	27	5I4.5ISOTM...028/011	2	22.5	5	TMC25-5	37.1-48
M48 X 5.0	5/8"	27	5I5.0ISOTM...028/075	2	20.0	4	TMC25-5	38.9-∞
M52 X 5.0	5/8"	27	5I5.0ISOTM...028/075	2	20.0	4	TMC25-5	38.9-∞

Sample tool requirement for thread **M14x2.0**.

Ordering code:

Insert: **2I2.0ISOTMVBX028/004**

Toolholder: **TMC20-2**

For toolholder information, see page 234.

## ISO Metric (con't)

### External / Internal

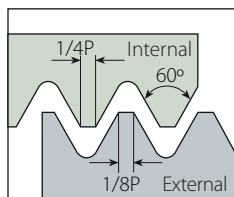

Defined by: R262 (DIN 13)  
Tolerance class: 6g/6H

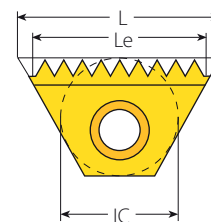

Standard TM

### Standard TM Inserts for TMO Toolholders

Insert Size		Pitch	Ordering Code		Toolholder	ECL
IC	L mm	mm	External	Internal	TMO	mm
1/4"	11	0.5		2I0.5ISOTM2...	TMOC20-2-8	19
		0.75	2E0.75ISOTM2...	2I0.75ISOTM2...	TMOC20-2-9	19.5
		1.0	2E1.0ISOTM2...	2I1.0ISOTM2...	TMOC20-2-8	19
		1.25	2E1.25ISOTM2...		TMOC20-2-10	18.75
		1.25		2I1.25ISOTM2...	TMOC20-2-10	16.25
		1.5	2E1.5ISOTM2...		TMOC20-2-8	18
		1.5		2I1.5ISOTM2...	TMOC20-2-8	19.5
3/8"	16	0.5		3I0.5ISOTM2...	TMOC20-3-1	28.5
		0.5		3I0.5ISOTM2...	TMOC20-3-10	29
		0.75	3E0.75ISOTM2...	3I0.75ISOTM2...	TMOC20-3-11	28.5
		1.0	3E1.0ISOTM2...		TMOC20-3-10	28
		1.0		3I1.0ISOTM2...	TMOC20-3-10	29
		1.25	3E1.25ISOTM2...	3I1.25ISOTM2...	TMOC20-3-7	28.75
		1.5	3E1.5ISOTM2...	3I1.5ISOTM2...	TMOC20-3-1	28.5
		1.75	3E1.75ISOTM2...	3I1.75ISOTM2...	TMOC20-3-12	26.25
5/8"	27	2.0	3E2.0ISOTM2...	3I2.0ISOTM2...	TMOC20-3-10	28
		1.0	5E1.0ISOTM2...	5I1.0ISOTM2...	TMOC25-5-12	46
		1.0	5E1.0ISOTM2...	5I1.0ISOTM2...	TMOC25-5-16	47
		1.25	5E1.25ISOTM2...	5I1.25ISOTM2...	TMOC25-5-13	48.75
		1.5	5E1.5ISOTM2...	5I1.5ISOTM2...	TMOC25-5-14	48
		1.5	5E1.5ISOTM2...	5I1.5ISOTM2...	TMOC25-5-16	46.5
		1.75	5E1.75ISOTM2...	5I1.75ISOTM2...	TMOC25-5-15	47.25
		2.0	5E2.0ISOTM2...	5I2.0ISOTM2...	TMOC25-5-12	44
		2.5	5E2.5ISOTM2...	5I2.5ISOTM2...	TMOC25-5-12	45
		2.5	5E2.5ISOTM2...	5I2.5ISOTM2...	TMOC25-5-14	47.5
		3.0	5E3.0ISOTM2...	5I3.0ISOTM2...	TMOC25-5-16	45
		3.5	5E3.5ISOTM2...	5I3.5ISOTM2...	TMOC25-5-16	45.5
		4.0	5E4.0ISOTM2...	5I4.0ISOTM2...	TMOC25-5-12	44
4.5	5E4.5ISOTM2...	5I4.5ISOTM2...	TMOC25-5-14	45		
5.0		5I5.0ISOTM...028/075	TMOC25-5-12	40		

Sample order: **2E0.75ISOTM2 VBX**

For Le and number of teeth of the above inserts, see the table for standard inserts on pages 209-210.

For toolholder information see page 239.

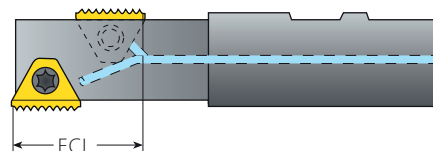

ECL - The Effective Cutting Length

## ISO Metric (con't)

### External / Internal

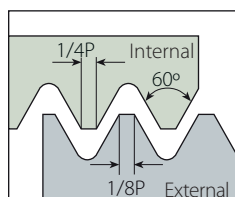

Defined by: R262 (DIN 13)  
 Tolerance class: 6g/6H

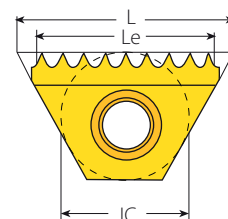

Fine Pitch TM

### Fine Pitch TM

Insert Size		Pitch	Ordering Code		Le	Teeth	Toolholder
IC	L mm	mm	External	Internal	mm		
6.0mm	10.4	0.35	6.0E0.35ISOTMF...	6.0I0.35ISOTMF...	9.45	14	TMMC...-6.0
		0.4	6.0E0.4ISOTMF...	6.0I0.4ISOTMF...	9.2	12	
		0.45	6.0E0.45ISOTMF...	6.0I0.45ISOTMF...	9.45	11	
		0.5	6.0E0.5ISOTMF...		9.5	10	
		0.6	6.0E0.6ISOTMF...		9.0	8	
		0.7	6.0E0.7ISOTMF...		9.1	7	
		0.75	6.0E0.75ISOTMF...		8.25	6	
		0.8	6.0E0.8ISOTMF...		8.8	6	
1/4"	11	0.9	6.0E0.9ISOTMF...		8.1	5	TMC...-2 TMSH...-2
		0.35	2E0.35ISOTM2F...	2I0.35ISOTM2F...	10.15	15	
		0.4	2E0.4ISOTM2F...	2I0.4ISOTM2F...	10.0	13	
		0.45	2E0.45ISOTM2F...	2I0.45ISOTM2F...	9.45	11	
		0.5	2E0.5ISOTM2F...		9.5	10	
		0.6	2E0.6ISOTM2F...		10.2	9	
		0.7	2E0.7ISOTM2F...		9.1	7	
		0.8	2E0.8ISOTM2F...		8.8	6	
3/8"	16	0.9	2E0.9ISOTM2F...		9.9	6	TMC...-3 TMSH...-3
		0.35	3E0.35ISOTM2F...	3I0.35ISOTM2F...	14.35	21	
		0.4	3E0.4ISOTM2F...	3I0.4ISOTM2F...	14.8	19	
		0.45	3E0.45ISOTM2F...	3I0.45ISOTM2F...	14.85	17	
		0.5	3E0.5ISOTM2F...		13.5	14	
		0.6	3E0.6ISOTM2F...		13.8	12	
		0.7	3E0.7ISOTM2F...		14.7	11	
		0.8	3E0.8ISOTM2F...		13.6	9	
		0.9	3E0.9ISOTM2F...		13.5	8	

NOTE: Two orbits are required to complete the thread. Fine Pitch TM Inserts produce partial profile thread.

Sample order: **6.0E0.35ISOTMF VBX**

All inserts have 2 cutting edges, except MiniTM (IC 6.0 mm), which has one cutting edge.

For toolholder information, see page 234.

### Fine Pitch Threads

Fine pitch threads are threads with small pitches. It is difficult to produce multitooth inserts for small pitches because of the small radius between the teeth. Vargus developed inserts where every second tooth was dropped to enlarge the radius between the teeth.

#### Important!

- All the fine pitch inserts are partial profile type (as a result of the enlarged radius).

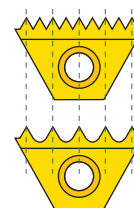

# American UN

## External / Internal

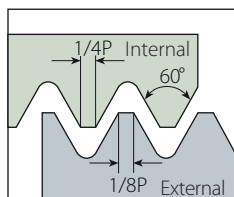

Defined by: ANSI B1.1.74  
Tolerance class: Class 2A/2B

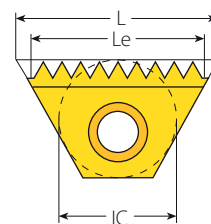

Standard TM

## Standard TM

Insert Size		Pitch	Ordering Code		Le	Teeth	Toolholder
IC	L mm	tpi	External	Internal	mm		
6.0mm	10.4	32		6.0I32UNTM...	9.53	12	TMMC...-6.0
		28		6.0I28UNTM...	9.07	10	
		24		6.0I24UNTM...	9.53	9	
		20		6.0I20UNTM...	8.89	7	
		18		6.0I18UNTM...	8.47	6	
		16		6.0I16UNTM...	7.94	5	
1/4"	11	48		2I48UNTM2...	10.05	19	TMC...-2 TMSH...-2
		40		2I40UNTM2...	10.16	16	
		32		2I32UNTM2...	10.32	13	
		28	2E28UNTM2...	2I28UNTM2...	9.98	11	
		27	2E27UNTM2...	2I27UNTM2...	10.35	11	
		24	2E24UNTM2...	2I24UNTM2...	9.53	9	
		20	2E20UNTM2...	2I20UNTM2...	10.16	8	
		18	2E18UNTM2...	2I18UNTM2...	9.88	7	
		16	2E16UNTM2...	2I16UNTM2...	9.53	6	
14	2E14UNTM2...	2I14UNTM2...	9.07	5			
3/8"	16	40		3I40UNTM2...	14.61	23	TMC...-3 TMSH...-3
		32		3I32UNTM2...	15.08	19	
		28	3E28UNTM2...	3I28UNTM2...	14.51	16	
		27	3E27UNTM2...	3I27UNTM2...	14.11	15	
		26	3E26UNTM2...	3I26UNTM2...	14.65	15	
		24	3E24UNTM2...	3I24UNTM2...	14.82	14	
		20	3E20UNTM2...	3I20UNTM2...	13.97	11	
		18	3E18UNTM2...	3I18UNTM2...	14.11	10	
		16	3E16UNTM2...	3I16UNTM2...	14.29	9	
		14	3E14UNTM2...	3I14UNTM2...	14.51	8	
		13	3E13UNTM2...	3I13UNTM2...	13.68	6	
		12	3E12UNTM2...	3I12UNTM2...	14.82	7	
3/8"B	22	24	3BE24UNTM2...	3BI24UNTM2...	21.16	20	BTMC...-3B TMSH...-3B
		20	3BE20UNTM2...	3BI20UNTM2...	21.59	17	
		18	3BE18UNTM2...	3BI18UNTM2...	21.17	15	
		16	3BE16UNTM2...	3BI16UNTM2...	20.64	13	
		14	3BE14UNTM2...	3BI14UNTM2...	21.77	12	
		13	3BE13UNTM2...	3BI13UNTM2...	21.49	11	
12	3BE12UNTM2...	3BI12UNTM2...	21.17	10			

Sample order: 3E24UNTM2 VBX All inserts have 2 cutting edges, except MiniTM (IC 6.0 mm), which has one cutting edge. For toolholder information, see page 234.



## American UN (con't)

### External / Internal

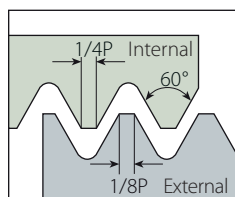

Defined by: ANSI B1.1.74  
 Tolerance class: Class 2A/2B

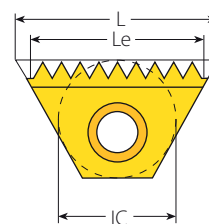

Standard TM

### Standard TM

Insert Size		Pitch	Ordering Code		Le	Teeth	Toolholder
IC	L mm	tpi	External	Internal	mm		
5/8"	27	24	5E24UNTM2...	5I24UNTM2...	25.40	24	TMC..-5 TMSH..-5
		20	5E20UNTM2...	5I20UNTM2...	25.40	20	
		18	5E18UNTM2...	5I18UNTM2...	25.40	18	
		16	5E16UNTM2...	5I16UNTM2...	25.40	16	
		14	5E14UNTM2...	5I14UNTM2...	25.40	14	
		13	5E13UNTM2...	5I13UNTM2...	25.40	13	
		12	5E12UNTM2...	5I12UNTM2...	25.40	12	
		11.5	5E11.5UNTM2...	5I11.5UNTM2...	24.30	11	
		11	5E11UNTM2...	5I11UNTM2...	25.40	11	
		10	5E10UNTM2...		22.86	9	
		10		5I10UNTM2...	25.40	10	
		9	5E9UNTM2...	5I9UNTM2...	22.58	8	
		8	5E8UNTM2...	5I8UNTM2...	22.23	7	
		7	5E7UNTM2...		21.77	6	
		7		5I7UNTM2...	25.40	7	
		6	5E6UNTM2...		21.17	5	
6		5I6UNTM2...	25.40	6			
3/4"B	38.5	6	6BE6UNTM2...	6BI6UNTM2...	38.87	8	TMC..-6B TMSH..-6B
		5	6BE5UNTM2...	6BI5UNTM2...	30.48	6	
		4.5	6BE4.5UNTM2...	6BI4.5UNTM2...	33.87	6	
		4	6BE4UNTM2...	6BI4UNTM2...	31.75	5	

Sample order: **5E24UNTM2 VBX**

All inserts have 2 cutting edges, except MiniTM (IC 6.0 mm), which has one cutting edge.

For toolholder information, see page 234.

# American UN (con't)

## Internal

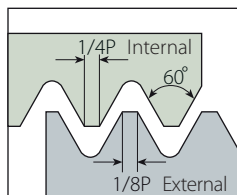

Defined by: ANSI B1.1.74  
Tolerance class: Class 2A/2B

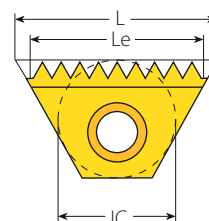

Coarse Pitch TM

## Coarse Pitch TM

Thread	Insert Size		Ordering Code	Cutting Edge	Le	Teeth	Toolholder	Bore Dia. Range
	IC	L mm						
7/16"-20UNF	6.0mm	10.4	6.0I20UNTM...028/012	1	8.89	7	TMMC12-6.0	9.7-11.4
7/16"-20UNF	6.0mm	10.4	6.0I20UNTM...028/012	1	8.89	7	TMMC20-6.0	9.7-11.4
7/16"-16UN	6.0mm	10.4	6.0I16UNTM...028/014	1	7.94	5	TMMC12-6.0	9.3-14.1
7/16"-16UN	6.0mm	10.4	6.0I16UNTM...028/014	1	7.94	5	TMMC20-6.0	9.3-14.1
7/16"-14UNC	6.0mm	10.4	6.0I14UNTM...028/013	1	9.07	5	TMMC20-6.0 124/003	9.1-9.9
1/2"-13UNC	1/4"	11	2I13UNTM...028/015	1	9.77	5	TMC20-2 124/005	10.5-19.5
1/2"-16UN	6.0mm	10.4	6.0I16UNTM...028/014	1	7.94	5	TMMC12-6.0	9.3-14.1
1/2"-16UN	6.0mm	10.4	6.0I16UNTM...028/014	1	7.94	5	TMMC20-6.0	9.3-14.1
9/16"-12UNC	1/4"	11	2I12UNTM...028/016	1	8.47	4	TMC20-2 124/005	11.9-15.6
9/16"-18UNF	1/4"	11	2I18UNTM...028/017	2	9.88	7	TMC12-2	12.7-14.5
9/16"-18UNF	1/4"	11	2I18UNTM...028/017	2	9.88	7	TMC20-2	12.7-14.5
9/16"-16UN	6.0mm	10.4	6.0I16UNTM...028/014	1	7.94	5	TMMC12-6.0	9.3-14.1
9/16"-16UN	6.0mm	10.4	6.0I16UNTM...028/014	1	7.94	5	TMMC20-6.0	9.3-14.1
5/8"-11UNC	1/4"	11	2I11UNTM...028/018	1	9.24	4	TMC20-2 124/006	13.3-18.5
5/8"-12UN	1/4"	11	2I12UNTM...028/016	1	8.47	4	TMC20-2 124/005	11.9-15.6
5/8"-16UN	6.0mm	10.4	6.0I16UNTM...028/014	1	7.94	5	TMMC12-6.0	9.3-14.1
5/8"-16UN	6.0mm	10.4	6.0I16UNTM...028/014	1	7.94	5	TMMC20-6.0	9.3-14.1
11/16"-12UN	1/4"	11	2I12UNTM...028/016	1	8.47	4	TMC20-2 124/005	11.9-15.6
3/4"-10UNC	3/8"	16	3I10UNTM...028/019	1	12.70	5	TMC16-3 124/001	16.3-31.6
3/4"-12UN	3/8"	16	3I12UNTM...028/020	2	14.82	7	TMNC16-3	16.7-18.3
13/16"-12UN	3/8"	16	3I12UNTM...028/020	2	14.82	7	TMC16-3	18.3-19.5
7/8"-9UNC	1/2"	22	4I9UNTM...028/021	1	16.93	6	TMC25-4 124/002	19.1-32.5

continued on next page ►

Sample tool requirement for thread 9/16"-12 UNC

Ordering codes:

Insert: 2I12UNTM VBX 028/016

Toolholder: TMC20-2 124/005

For toolholder information, see page 234.

## American UN (con't)

### Internal

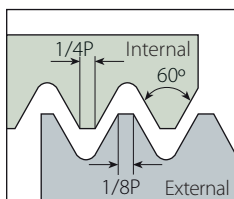

Defined by: ANSI B1.1.74  
 Tolerance class: Class 2A/2B

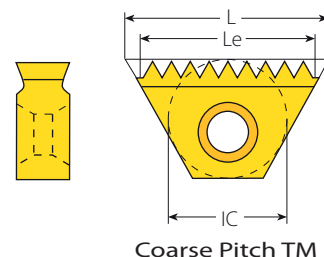

### Coarse Pitch TM (con't)

Thread	Insert Size		Ordering Code	Cutting Edge	Le	Teeth	Toolholder	Bore Dia. Range
	IC	L mm						
1"-8UNC	1/2"	22	418UNTM...028/022	1	19.05	6	TMC25-4 124/007	21.9-28.3
1 1/16"-8UN	1/2"	22	418UNTM...028/022	1	19.05	6	TMC25-4 124/007	21.9-28.3
1 1/8"-7UNC	1/2"	22	417UNTM...028/023	1	18.14	5	TMC25-4 124/002	24.6-35.9
1 1/8"-8UN	1/2"	22	418UNTM...028/022	1	19.05	6	TMC25-4 124/007	21.9-28.3
1 3/16"-8UN	1/2"	22	418UNTM...028/022	1	19.05	6	TMC25-4 124/007	21.9-28.3
1 1/4"-7UNC	1/2"	22	417UNTM...028/023	1	18.14	5	TMC25-4 124/002	24.6-35.9
1 1/4"-8UN	5/8"	27	518UNTM...028/024	2	22.23	7	TMC25-5 124/004	28.3-33.0
1 5/16"-8UN	5/8"	27	518UNTM...028/024	2	22.23	7	TMC25-5 124/004	28.3-33.0
1 3/8"-6UNC	5/8"	27	516UNTM...028/025	2	25.40	6	TMC25-5 124/004	30.3-36.7
1 3/8"-8UN	5/8"	27	518UNTM...028/024	2	22.23	7	TMC25-5 124/004	28.3-33.0
1 7/16"-6UN	5/8"	27	516UNTM...028/025	2	25.40	6	TMC25-5 124/004	30.3-36.7
1 7/16"-8UN	5/8"	27	518UNTM...028/024	2	22.23	7	TMC25-5	33.0-39.0
1 1/2"-6UNC	5/8"	27	516UNTM...028/025	2	25.40	6	TMC25-5 124/004	30.3-36.7
1 1/2"-8UN	5/8"	27	518UNTM...028/024	2	22.23	7	TMC25-5	33.0-39.0
1 9/16"-6UN	5/8"	27	516UNTM...028/025	2	25.40	6	TMC25-5 124/004	30.3-36.7
1 9/16"-8UN	5/8"	27	518UNTM...028/024	2	22.23	7	TMC25-5	33.0-39.0
1 5/8"-6UN	5/8"	27	516UNTM...028/025	2	25.40	6	TMC25-5	36.7-45.0
1 5/8"-8UN	5/8"	27	518UNTM...028/024	2	22.23	7	TMC25-5	33.0-39.0
1 11/16"-6UN	5/8"	27	516UNTM...028/025	2	25.40	6	TMC25-5	36.7-45.0
1 3/4"-5UNC	5/8"	27	515UNTM...028/077	2	20.32	4	TMC25-5	38.9-∞
1 3/4"-6UN	5/8"	27	516UNTM...028/025	2	25.40	6	TMC25-5	36.7-45.0
1 13/16"-6UN	5/8"	27	516UNTM...028/025	2	25.40	6	TMC25-5	36.7-45.0
1 7/8"-6UN	5/8"	27	516UNTM...028/025	2	25.40	6	TMC25-5	36.7-45.0
1 15/16"-6UN	5/8"	27	516UNTM...028/025	2	25.40	6	TMC25-5	36.7-45.0

Sample tool requirement for thread 1 9/16"-6 UN

Ordering codes:

Insert: **516UNTM VBX 028/025**

Toolholder: **TMC 25-5 124/004**

For toolholder information, see page 234.

## American UN (con't)

### External / Internal

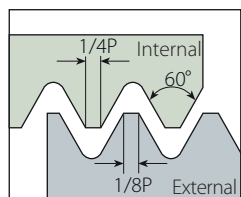

Defined by: ANSI B1.1.74  
Tolerance class: Class 2A/2B

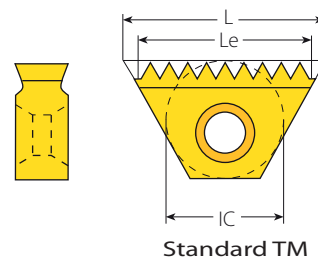

### Standard TM Inserts for TMO Toolholders

Insert Size		Pitch	Ordering Code		Toolholder	ECL
IC	L mm	tpi	External	Internal	TMO	mm
1/4"	11	48		2I48UNTM2...	TMOC20-2-1	19.58
		48		2I48UNTM2...	TMOC20-2-2	18.52
		48		2I48UNTM2...	TMOC20-2-9	19.05
		32		2I32UNTM2...	TMOC20-2-1	19.85
		28	2E28UNTM2...	2I28UNTM2...	TMOC20-2-3	17.24
		24	2E24UNTM2...	2I24UNTM2...	TMOC20-2-2	17.99
		20	2E20UNTM2...	2I20UNTM2...	TMOC20-2-4	19.05
		18	2E18UNTM2...	2I18UNTM2...	TMOC20-2-2	18.34
		16	2E16UNTM2...	2I16UNTM2...	TMOC20-2-1	19.05
3/8"	16	32		3I32UNTM2...	TMOC20-3-3	27.78
		32		3I32UNTM2...	TMOC20-3-11	28.58
		28	3E28UNTM2...	3I28UNTM2...	TMOC20-3-3	27.21
		27	3E27UNTM2...	3I27UNTM2...	TMOC20-3-4	27.28
		24	3E24UNTM2...	3I24UNTM2...	TMOC20-3-6	27.52
		20	3E20UNTM2...	3I20UNTM2...	TMOC20-3-6	26.67
		18	3E18UNTM2...	3I18UNTM2...	TMOC20-3-6	26.82
		16	3E16UNTM2...	3I16UNTM2...	TMOC20-3-6	26.99
		14	3E14UNTM2...	3I14UNTM2...	TMOC20-3-6	27.21
		13	3E13UNTM2...	3I13UNTM2...	TMOC20-3-2	25.4
		12	3E12UNTM2...	3I12UNTM2...	TMOC20-3-6	27.52
11.5	3E11.5UNTM2...	3I11.5UNTM2...	TMOC20-3-5	24.3		

continued on next page ▶

Sample order: **2E16UNTM2 VBX**

For Le and number of teeth of the above inserts, see the table for standard inserts on page 214-215.  
For toolholder information, see page 239.

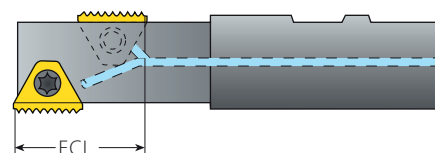

ECL - The Effective Cutting Length

## American UN (con't)

### External / Internal

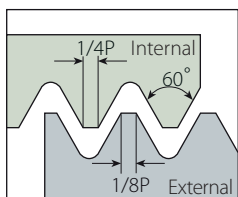

Defined by: ANSI B1.1.74  
Tolerance class: Class 2A/2B

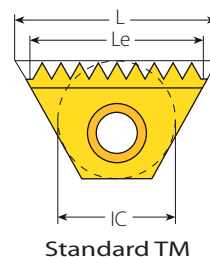

Standard TM

### Standard TM Inserts for TMO Toolholders (con't)

Insert Size		Pitch	Ordering Code		Toolholder	ECL
IC	L mm	tpi	External	Internal	TMO	mm
5/8"	27	24	5E24UNTM2...	5I24UNTM2...	TMOC25-5-1	50.80
		24	5E24UNTM2...	5I24UNTM2...	TMOC25-5-2	46.57
		20	5E20UNTM2...	5I20UNTM2...	TMOC25-5-1	50.80
		18	5E18UNTM2...	5I18UNTM2...	TMOC25-5-1	50.80
		18	5E18UNTM2...	5I18UNTM2...	TMOC25-5-2	46.57
		16	5E16UNTM2...	5I16UNTM2...	TMOC25-5-3	47.63
		14	5E14UNTM2...	5I14UNTM2...	TMOC25-5-1	50.80
		14	5E14UNTM2...	5I14UNTM2...	TMOC25-5-4	47.17
		13	5E13UNTM2...	5I13UNTM2...	TMOC25-5-1	50.80
		12	5E12UNTM2...	5I12UNTM2...	TMOC25-5-2	46.57
		12	5E12UNTM2...	5I12UNTM2...	TMOC25-5-1	50.80
		11.5	5E11.5UNTM2...	5I11.5UNTM2...	TMOC25-5-5	46.38
		11	5E11UNTM2...	5I11UNTM2...	TMOC25-5-6	48.49
		11	5E11UNTM2...	5I11UNTM2...	TMOC25-5-1	46.18
		10	5E10UNTM2...	5I10UNTM2...	TMOC25-5-7	43.18
		10	5E10UNTM2...	5I10UNTM2...	TMOC25-5-7	45.72
		9	5E9UNTM2...	5I9UNTM2...	TMOC25-5-8	45.16
		8	5E8UNTM2...	5I8UNTM2...	TMOC25-5-9	44.45
		7	5E7UNTM2...	5I7UNTM2...	TMOC25-5-10	43.54
		7	5E7UNTM2...	5I7UNTM2...	TMOC25-5-10	47.17
6	5E6UNTM2...	5I6UNTM2...	TMOC25-5-2	42.33		
6	5E6UNTM2...	5I6UNTM2...	TMOC25-5-2	46.57		
5	5E5UNTM2...	5I5UNTM...028/077	TMOC25-5-7	40.64		

Sample order: **5E16UNTM2 VBX**

For Le and number of teeth of the above inserts, see table for standard inserts on page 214-215.

For toolholder information, see page 239.

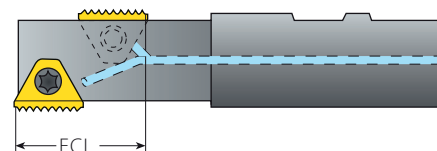

ECL - The Effective Cutting Length

## American UN (con't)

### External / Internal

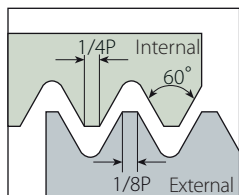

Defined by: ANSI B1.1.74  
Tolerance class: Class 2A/2B

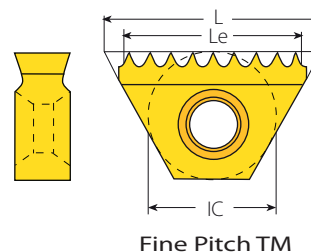

Fine Pitch TM

### Fine Pitch TM

Insert Size		Pitch	Ordering Code		Le	Teeth	Toolholder
IC	L mm	tpi	External	Internal	mm		
6.0mm	10.4	80	6.0E80UNTMF...	6.0I80UNTMF...	9.84	16	TMMC...-6.0
		72	6.0E72UNTMF...	6.0I72UNTMF...	9.53	14	
		64	6.0E64UNTMF...	6.0I64UNTMF...	9.13	12	
		56	6.0E56UNTMF...	6.0I56UNTMF...	9.53	11	
		48	6.0E48UNTMF...		9.00	9	
		44	6.0E44UNTMF...		8.66	8	
		40	6.0E40UNTMF...		8.26	7	
		36	6.0E36UNTMF...		9.17	7	
1/4"	11	80	2E80UNTM2F...	2I80UNTM2F...	9.84	16	TMC...-2 TMSH...-2
		72	2E72UNTM2F...	2I72UNTM2F...	10.23	15	
		64	2E64UNTM2F...	2I64UNTM2F...	9.92	13	
		56	2E56UNTM2F...	2I56UNTM2F...	9.53	11	
		48	2E48UNTM2F...		10.05	10	
		44	2E44UNTM2F...		9.81	9	
		40	2E40UNTM2F...		9.53	8	
		36	2E36UNTM2F...		9.17	7	
3/8"	16	80	3E80UNTM2F...	3I80UNTM2F...	14.29	23	TMC...-3 TMSH...-3
		72	3E72UNTM2F...	3I72UNTM2F...	14.46	21	
		64	3E64UNTM2F...	3I64UNTM2F...	14.68	19	
		56	3E56UNTM2F...	3I56UNTM2F...	14.06	16	
		48	3E48UNTM2F...		14.29	14	
		44	3E44UNTM2F...		14.43	13	
		40	3E40UNTM2F...		14.61	12	
		36	3E36UNTM2F...		14.82	11	
		32	3E32UNTM2F...		13.49	9	

NOTE: Two orbits are required to complete the thread. Fine Pitch TM Inserts produce partial profile thread.

Sample order: **6.0E80UNTMF VBX**

All inserts have 2 cutting edges, except MiniTM (IC 6.0 mm), which has one cutting edge.

For toolholder information, see page 234.

### Fine Pitch Threads

Fine pitch threads are threads with small pitches. It is difficult to produce multitooth inserts for small pitches because of the small radius between the teeth. Vargus developed inserts where every second tooth was dropped to enlarge the radius between the teeth.

#### Important!

- All the fine pitch inserts are partial profile type (as a result of the enlarged radius).

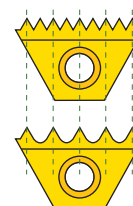

# UNJ

## External / Internal

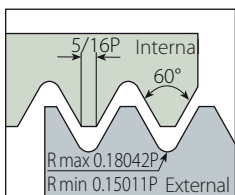

Defined by: MIL-S-8879C  
 Tolerance class: 3A/3B

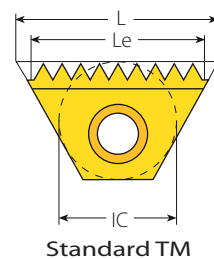

Standard TM

## Standard TM

Insert Size		Pitch	Ordering Code		Le	Teeth	Toolholder
IC	L mm	tpi	External	Internal	mm		
6.0mm	10.4	24		6.0I24UNJTM...	9.53	9	TMMC...-6.0
		20		6.0I20UNJTM...	8.89	7	
		18		6.0I18UNJTM...	8.47	6	
		16		6.0I16UNJTM...	9.53	6	
1/4"	11	24	2E24UNJTM2...	2I24UNJTM2...	9.53	9	TMC...-2 TMSH...-2
		20	2E20UNJTM2...	2I20UNJTM2...	10.16	8	
		18		2I18UNJTM2...	9.88	7	
		16	2E16UNJTM2...	2I16UNJTM2...	9.53	6	
		14	2E14UNJTM2...	2I14UNJTM2...	9.07	5	
3/8"	16	24	3E24UNJTM2...	3I24UNJTM2...	14.82	14	TMC...-3 TMSH...-3
		20	3E20UNJTM2...	3I20UNJTM2...	13.97	11	
		18	3E18UNJTM2...	3I18UNJTM2...	14.11	10	
		16	3E16UNJTM2...	3I16UNJTM2...	14.29	9	
		14	3E14UNJTM2...	3I14UNJTM2...	14.51	8	
		12	3E12UNJTM2...	3I12UNJTM2...	14.82	7	
5/8"	27	16	5E16UNJTM2...	5I16UNJTM2...	25.40	16	TMC...-5 TMSH...-5
		12	5E12UNJTM2...	5I12UNJTM2...	25.40	12	
		11	5E11UNJTM2...	5I11UNJTM2...	25.40	11	

Insert ordering code: **3E16UNJTM2 VBX**

All inserts have 2 cutting edges, except MiniTM (IC 6.0 mm), which has one cutting edge.

For toolholder information, see page 234.

## W for BSW, BSP

### External / Internal

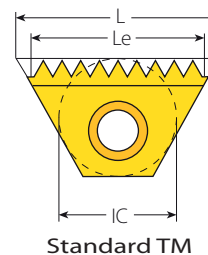
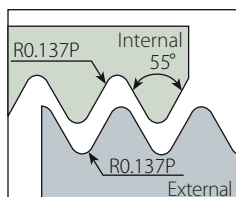

Standard TM

BSW Defined by: B.S.84:1956, DIN 259, ISO228/1:1982

BSP Defined by: B.S.2779:1956

Tolerance class: BSW-Medium class A, BSP-Medium class

### Standard TM

Insert Size		Pitch	Ordering Code	Le	Teeth	Toolholder
IC	L mm	tpi	External + Internal	mm		
6.0mm	10.4	28	6.0EI28WTM...	9.07	10	TMMC...-6.0
		26	6.0EI26WTM...	8.79	9	
		24	6.0EI24WTM...	9.53	9	
		20	6.0EI20WTM...	8.89	7	
		19	6.0EI19WTM...	9.36	7	
1/4"	11	28	2EI28WTM2...	9.98	11	TMC...-2 TMSH...-2
		26	2EI26WTM2...	9.77	10	
		24	2EI24WTM2...	9.53	9	
		20	2EI20WTM2...	10.16	8	
		19	2EI19WTM2...	9.36	7	
3/8"	16	26	3EI26WTM2...	14.65	15	TMC...-3 TMSH...-3
		24	3EI24WTM2...	14.82	14	
		20	3EI20WTM2...	13.97	11	
		19	3EI19WTM2...	14.71	11	
		18	3EI18WTM2...	14.11	10	
		16	3EI16WTM2...	14.29	9	
		14	3EI14WTM2...	14.51	8	
3/8"B	22	24	3BEI24WTM2...	21.17	20	TMC...-3B TMSH...-3B
		20	3BEI20WTM2...	21.59	17	
		19	3BEI19WTM2...	21.39	16	
		18	3BEI18WTM2...	21.17	15	
		16	3BEI16WTM2...	20.64	13	
		14	3BEI14WTM2...	21.77	12	
		12	3BEI12WTM2...	21.17	10	
5/8"	27	16	5EI16WTM2...	25.40	16	TMC...-5 TMSH...-5
		14	5EI14WTM2...	25.40	14	
		12	5EI12WTM2...	23.28	11	
		11	5EI11WTM2...	23.09	10	
		10	5EI10WTM2...	25.40	10	
		9	5EI9WTM2...	22.58	8	
		8	5EI8WTM2...	22.23	7	
3/4"B	38.5	11	6BEI11WTM2...	34.64	15	TMC...-6B TMSH...-6B
		6	6BEI6WTM2...	33.87	8	
		5	6BEI5WTM2...	30.48	6	
		4.5	6BEI4.5WTM2...	33.87	6	



## W for BSW only (con't)

### External / Internal

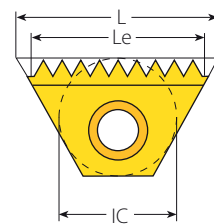
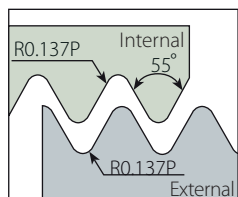

Coarse Pitch TM

Defined by: B.S.84:1956, DIN259, ISO228/1:1982  
 Tolerance class: Medium class A

### Coarse Pitch TM

Thread	Insert Size		Ordering Code	Cutting Edge	Le	Teeth	Toolholder	Bore Dia. Range
Inch	IC	L mm	Internal		mm			mm
7/16"-18	6.0mm	10.4	6.0I18WTM...028/035	1	8.47	6	TMMC12-6.0	9.3-14.2
7/16"-18	6.0mm	10.4	6.0I18WTM...028/035	1	8.47	6	TMMC20-6.0	9.3-14.2
7/16"-26	6.0mm	10.4	6.0I26WTM... 028/036	1	8.79	9	TMMC12-6.0	9.8-10.5
7/16"-26	6.0mm	10.4	6.0I26WTM... 028/036	1	8.79	9	TMMC20-6.0	9.8-10.5
1/2"-16	1/4"	11	2I16WTM... 028/051	1	9.53	6	TMC20-2 124/005	10.6-12.2
1/2"-20	6.0mm	10.4	6.0I20WTM...028/037	1	8.89	7	TMMC12-6.0	11.0-11.4
1/2"-20	6.0mm	10.4	6.0I20WTM...028/037	1	8.89	7	TMMC20-6.0	11.0-11.4
9/16"-16	1/4"	11	2I16WTM...028/038	2	9.53	6	TMC12-2	12.2-18.5
9/16"-16	1/4"	11	2I16WTM...028/038	2	9.53	6	TMC20-2	12.2-18.5
5/8"-14	1/4"	11	2I14WTM...028/039	1	9.07	5	TMC20-2 124/006	13.5-19.0
11/16"-14	1/4"	11	2I14WTM...028/039	1	9.07	5	TMC20-2 124/006	13.5-19.0
11/16"-16	1/4"	11	2I16WTM...028/038	2	9.53	6	TMC12-2	12.2-18.5
11/16"-16	1/4"	11	2I16WTM...028/038	2	9.53	6	TMC20-2	12.2-18.5
3/4"-12	3/8"	16	3I12WTM...028/040	1	14.82	7	TMC16-3 124/001	16.3-17.9
3/4"-16	1/4"	11	2I16WTM...028/038	2	9.53	6	TMC12-2	12.2-18.5
3/4"-16	1/4"	11	2I16WTM...028/038	2	9.53	6	TMC20-2	12.2-18.5
13/16"-12	3/8"	16	3I12WTM...028/041	2	14.82	7	TMC16-3	17.9-21.0
7/8"-9	1/2"	22	4I9WTM...028/042	1	16.93	6	TMC25-4 124/002	18.6-32.5
7/8"-11	1/2"	22	4I11WTM...028/043	1	18.47	8	TMC25-4 124/002	19.2-22.0
15/16"-12	3/8"	16	3I12WTM...028/041	2	14.82	7	TMC20-3	21.0-30.6
1"-8	1/2"	22	4I8WTM...028/044	1	15.88	5	TMC25-4 124/002	21.3-26.0
1"-10	1/2"	22	4I10WTM...028/045	1	17.78	7	TMC25-4 124/002	22.1-31.6
1"-12	3/8"	16	3I12WTM...028/041	2	14.82	7	TMC20-3	21.0-30.6
1 1/16"-12	3/8"	16	3I12WTM...028/041	2	14.82	7	TMC20-3	21.0-30.6
1 1/8"-7	5/8"	27	5I7WTM...028/046	1	21.77	6	TMC25-5 124/008	23.9-27.1
1 1/8"-9	1/2"	22	4I9WTM...028/042	1	16.93	6	TMC25-4 124/002	18.6-32.5
1 1/8"-12	3/8"	16	3I12WTM...028/041	2	14.82	7	TMC20-3	21.0-30.6
1 3/16"-8	5/8"	27	5I8WTM...028/047	2	22.23	7	TMC25-5 124/004	26.0-32.4
1 3/16"-12	3/8"	16	3I12WTM...028/041	2	14.82	7	TMC20-3	21.0-30.6
1 1/4"-7	5/8"	27	5I7WTM...028/048	2	21.77	6	TMC25-5 124/004	21.7-35.9
1 1/4"-9	1/2"	22	4I9WTM...028/042	1	16.93	6	TMC25-4 124/002	18.6-32.5
1 1/4"-12	3/8"	16	3I12WTM...028/041	2	14.82	7	TMC20-3	21.0-30.6
1 5/16"-6	5/8"	27	5I6WTM...028/049	2	21.17	5	TMC25-5 124/004	27.9-32.6
1 5/16"-8	5/8"	27	5I8WTM...028/047	2	22.23	7	TMC25-5 124/004	26.0-32.4

continued on next page ►

Sample tool requirement for thread 7/16"-18 BSW

Ordering codes: Insert: **6.0I18WTM VBX 028/035** Toolholder: **TMMC 20-6.0**

For toolholder information, see page 234.

## W for BSW only (con't)

### Internal

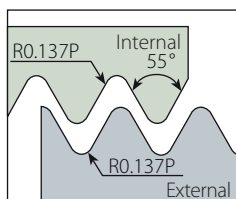

Defined by: B.S.84:1956, DIN259, ISO228/1:1982  
Tolerance class: Medium class A

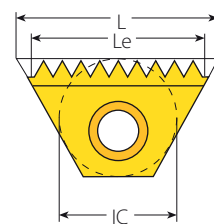

Coarse Pitch TM Inserts

### Coarse Pitch TM

Thread	Insert Size		Ordering Code	Cutting Edge	Le	Teeth	Toolholder	Bore Dia. Range
	IC	L mm						
1 5/16"-12	3/8"	16	3I12WTM...028/041	2	14.82	7	TMC20-3	21.0-30.6
1 3/8"-8	5/8"	27	5I8WTM...028/047	2	22.23	7	TMC25-5 124/004	26.0-32.4
1 3/8"-6	5/8"	27	5I6WTM...028/049	2	21.17	5	TMC25-5 124/004	27.9-32.6
1 3/8"-12	5/8"	27	5I12WTM...028/050	2	23.28	11	TMC25-5	32.2-34.6
1.4-6	5/8"	27	5I6WTM...028/049	2	21.17	5	TMC25-5 124/004	27.9-32.6
1.4-8	5/8"	27	5I8WTM...028/047	2	22.23	7	TMC25-5124/004	26.0-32.4
1.4-12	5/8"	27	5I12WTM...028/050	2	23.28	11	TMC25-5	32.2-34.6
1 7/16"-6	5/8"	27	5I6WTM...028/049	2	21.17	5	TMC25-5 124/004	27.9-32.6
1 7/16"-8	5/8"	27	5I8WTM...028/047	2	22.23	7	TMC25-5	32.4-39.0
1 7/16"-12	5/8"	27	5I12WTM...028/050	2	23.28	11	TMC25-5	32.2-34.6
1 1/2"-6	5/8"	27	5I6WTM...028/049	2	21.17	5	TMC25-5 124/004	27.9-32.7
1 1/2"-8	5/8"	27	5I8WTM...028/047	2	22.23	7	TMC25-5	32.4-39.0
1.6-6	5/8"	27	5I6WTM...028/049	2	21.17	5	TMC25-5	32.6-38.5
1.6-8	5/8"	27	5I8WTM...028/047	2	22.23	7	TMC25-5	32.4-39.0
1 5/8"-8	5/8"	27	5I8WTM...028/047	2	22.23	7	TMC25-5	32.4-39.0
1 5/8"-6	5/8"	27	5I6WTM...028/049	2	21.17	5	TMC25-5	32.6-38.5
1 3/4"-7	5/8"	27	5I7WTM...028/048	2	21.77	6	TMC25-5	39.8-42.0
1 7/8"-6	5/8"	27	5I6 WTM...028/049	2	21.17	5	TMC32-5	42.2-45.0
1.9-6	5/8"	27	5I6 WTM...028/049	2	21.17	5	TMC32-5	42.2-45.0

Sample tool requirement for thread 1 5/16"-12 BSW

Ordering codes: Insert: **3I12WTM VBX 028/041**

Toolholder: **TMC 20-3**

For toolholder information, see page 234.

## W for BSW only (con't)

### External / Internal

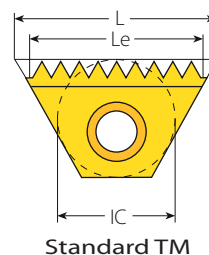
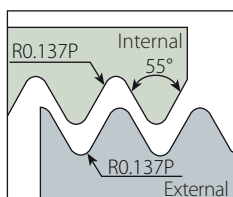

BSW Defined by: B.S.84:1956, DIN 259, ISO228/1:1982  
 BSP Defined by: B.S.2779:1956  
 Tolerance class: BSW-Medium class A, BSP-Medium class

### Standard TM Inserts for TMO Toolholders

Insert Size		Pitch	Ordering Code	ECL	
IC	L mm	tpi	External + Internal	TMO	
1/4"	11	28	2EI28WTM2...	TMOC20-2-3	17.24
		26	2EI26WTM2...	TMOC20-2-5	18.56
		24	2EI24WTM2...	TMOC20-2-2	17.99
		20	2EI20WTM2...	TMOC20-2-6	19.05
		19	2EI19WTM2...	TMOC20-2-7	17.38
		14	2EI14WTM2...	TMOC20-2-3	16.33
3/8"	16	26	3EI26WTM2...	TMOC20-3-2	27.35
		26	3EI26WTM2...	TMOC20-3-6	26.38
		24	3EI24WTM2...	TMOC20-3-7	28.57
		20	3EI20WTM2...	TMOC20-3-6	26.67
		19	3EI19WTM2...	TMOC20-3-8	28.07
		18	3EI18WTM2...	TMOC20-3-6	26.81
		16	3EI16WTM2...	TMOC20-3-6	26.99
		14	3EI14WTM2...	TMOC20-3-6	27.21
5/8"	27	12	3EI12WTM2...	TMOC20-3-6	27.52
		11	3EI11WTM2...	TMOC20-3-9	27.71
		16	5EI16WTM2...	TMOC25-5-3	47.63
		14	5EI14WTM2...	TMOC25-5-1	50.80
		14	5EI14WTM2...	TMOC25-5-4	47.17
		12	5EI12WTM2...	TMOC25-5-2	44.45
		11	5EI11WTM2...	TMOC25-5-6	46.18
		10	5EI10WTM2...	TMOC25-5-7	45.72
		9	5EI9WTM2...	TMOC25-5-8	45.16
		8	5EI8WTM2...	TMOC25-5-9	44.45
7	5EI7WTM2...	TMOC25-5-4	43.54		
6	5EI6WTM2...	TMOC25-5-11	42.33		

Sample order: **3EI19WTM2 VBX**

For Le and number of teeth of the above inserts, see the table for standard inserts on page 222.

For toolholder information see page 239.

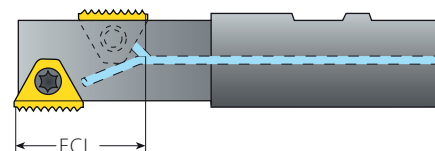

ECL - The Effective Cutting Length

# NPT

## External / Internal

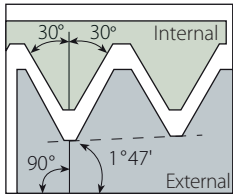

Defined by: USAS B2.1:1968  
Tolerance class: Standard NPT

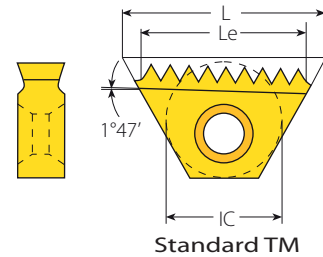

## Standard TM

Insert Size		Pitch	Ordering Code	Le	Teeth	Toolholder	
IC	L mm	tpi	External + Internal	mm		RH	LH
3/8"	16	18	3E18NPTTM2... **	14.11	10		
		14	3E14NPTTM2...	14.51	8	TMNC...-3	TMNC...-3LH
		11.5	3E11.5NPTTM2...	13.25	6		
3/8"B	22	14	3BE14NPTTM2...	21.77	12	BTMNC...-3B	BTMNC...-3BLH
		11.5	3BE11.5NPTTM2... *	19.88	9		
5/8"	27	11.5	5E11.5NPTTM2...	24.30	11	TM.C...-5	TM.C...-5LH
		8	5E18NPTTM2...	22.23	7		
3/4"B	38.5	11.5	6BE11.5NPTTM2...	35.34	16	TMC...-6B	TMC...-6BLH
		8	6BE18NPTTM2...	31.75	10		

\* Single sided insert - RH only

\*\* For external thread only

Sample order: 3E14NPTTM VBX

**NOTE:** To thread with insert cutting edge marked "L", use LH toolholders.

For toolholder information, see page 234.

# NPT

## Internal

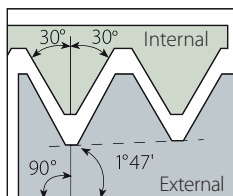

Defined by: USAS B2.1:1968  
Tolerance class: Standard NPT

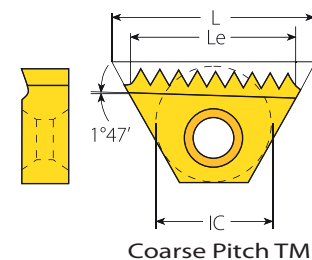

## Coarse Pitch TM

Thread	Insert Size		Ordering Code	Cutting Edge	Le	Teeth	Toolholder
Inch	IC	L mm	Internal		mm		
1/4"-18	1/4"	11	2I18NPTTM...028/074	1	9.88	7	TMC 20-2 124/009
3/8"-18	1/4"	11	2I18NPTTM...028/074	1	9.88	7	TMC 20-2 124/009

Sample order: 2I18NPTTM VBX 028/074

**NOTE:** To thread with insert cutting edge marked "L", use LH toolholders.

For toolholder information, see page 234.

## NPTF (Dry Seal)

### External / Internal

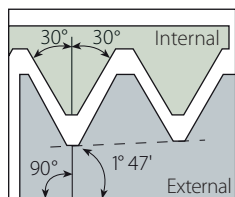

Defined by: ANSI 1.20.3-1976  
 Tolerance class: Standard NPTF

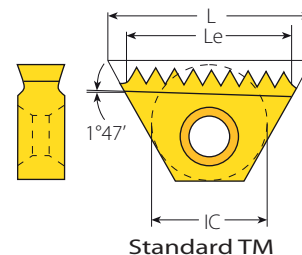

Standard TM

### Standard TM

Insert Size		Pitch	Ordering Code	Le	Teeth	Toolholder	
IC	L mm	tpi	External + Internal	mm		RH	LH
3/8"	16	14	3EI14NPTFTM2...	14.51	8	TMNC..-3	TMNC..-3LH
		11.5	3EI11.5NPTFTM2...	13.25	6		
3/8"B	22	14	3BEI14NPTFTM2...	21.77	12	BTMNC..-3B	BTMNC..-3BLH
		11.5	3BEI11.5NPTFTM2...	19.88	9		
5/8"	27	11.5	5EI11.5NPTFTM2...	24.30	11	TM.C..-5	TM.C..-5LH
		8	5EI8NPTFTM2...	22.23	7		
3/4"B	38.5	11.5	6BEI11.5NPTFTM2...	35.34	16	TMC..-6B	TMC..-6BLH
		8	6BEI8NPTFTM2...	31.75	10		

Sample order: 3EI14NPTFTMVBX

NOTE: To thread with insert cutting edge marked "L", use LH toolholders.

For toolholder information, see page 234.

## NPTF (Dry Seal)

### Internal

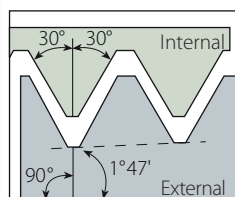

Defined by: ANSI 1.20.3-1976  
 Tolerance class: Standard NPTF

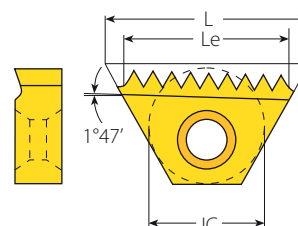

Coarse Pitch TM

### Coarse Pitch TM

Thread	Insert Size		Ordering Code	Cutting Edge	Le	Teeth	Toolholder
Inch	IC	L mm	Internal		mm		
1/4"-18	1/4"	11	2I18NPTFTM...028/078	1	9.88	7	TMC20-2 124/009
3/8"-18	1/4"	11	2I18NPTFTM...028/078	1	9.88	7	TMC20-2 124/009

Sample tool requirement for thread 1/4" - 18NPTF

Ordering Codes Insert: 2I18NPTFTMVBX 028/078

Toolholders: TMC20-2 124/009

## NPS

### External / Internal

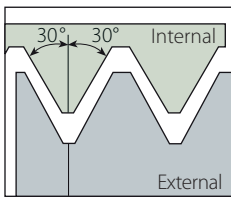

Defined by: USA NBS H28 (1957)  
Tolerance class: Standard NPS

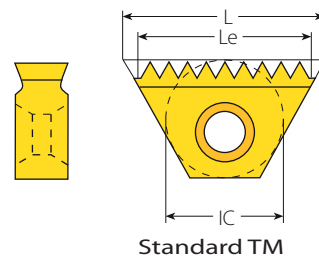

Standard TM

### Standard TM

Insert Size		Pitch		Ordering Code	Le	Teeth	Nominal Thread Size	Toolholder
IC	L mm	tpi	External + Internal		mm			
3/8"	16	14	3EI14NPSTM2...	14.51	8	1/2"	TMNC16-3	
		14	3EI14NPSTM2...	14.51	8	3/4"	TMNC20-3	
3/8"B	22	11.5	3EI11.5NPSTM2...	13.25	6	1", 1 1/4"	TMNC20-3	
		11.5	3BEI11.5NPSTM2...*	19.88	9	1", 1 1/4"	BTMNC20-3B	
5/8"	27	11.5	5EI11.5NPSTM2...	24.30	11	1 1/2", 2"	TMC25-5	
		8	5EI8NPSTM2...	22.23	7	2 1/2" & larger	TMC32-5	

Sample Order: 5EI11.5NPSTM2VBX

All inserts have 2 cutting edges.

For toolholder information, see page 234.

\* One cutting edge.

## BSPT

### External / Internal

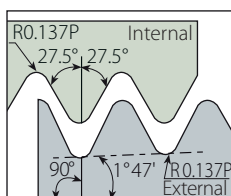

Defined by: B.S. 21:1985  
Tolerance class: Standard BSPT

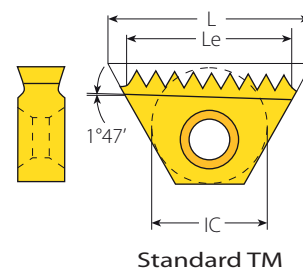

Standard TM

### Standard TM

Insert Size		Pitch		Ordering Code	Le	Teeth	Toolholder	
IC	L mm	tpi	External + Internal		mm		RH	LH
1/4"	11	19	2EI19BSPTTM2...	9.36	7	TMNC..-2		TMC..-2LH
3/8"	16	14	3EI14BSPTTM2...	14.51	8	TMNC..-3		TMNC..-3LH
		11	3EI11BSPTTM2...	13.85	6			
5/8"	27	11	5EI11BSPTTM2...	23.09	10	TMC..-5		TMC..-5LH

Sample Order: 5EI11BSPTTM VBX

NOTE: To thread with insert cutting edge marked "L", use a LH toolholder.

For toolholder information, see page 234.

# Pg

## External / Internal

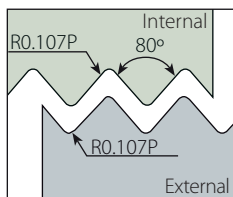

Defined by: DIN 40430  
Tolerance class: Standard

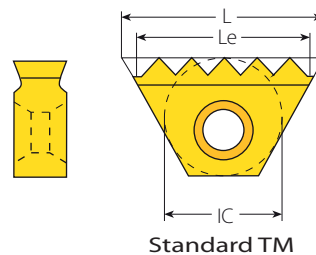

## Standard TM

Insert Size		Pitch	Ordering Code	Le	Teeth	Nominal Thread Size	Toolholder
IC	L mm	tpi	External + Internal	mm			
6.0mm	10.4	20	6.0EI20PGTM...	8.99	7	Pg7	TMMC...-6.0
1/4"	11	20	2EI20PGTM2...	10.16	8	Pg7	TMC...-2
		18	2EI18PGTM2...	9.88	7	Pg9, Pg11, Pg13.5, Pg16	TMSH...-2
		16	2EI16PGTM2...	9.53	6	Pg21, Pg29, Pg36, Pg42, Pg48	
3/8"	16	20	3EI20PGTM2...	13.97	11	Pg7	TMC...-3
		18	3EI18PGTM2...	14.11	10	Pg9, Pg11, Pg13.5, Pg16	TMSH...-3
		16	3EI16PGTM2...	14.29	9	Pg21, Pg29, Pg36, Pg42, Pg48	
5/8"	27	16	5EI16PGTM2...	25.40	16	Pg21, Pg29, Pg36, Pg42, Pg48	TMC...-5, TMSH...-5

Insert Ordering Code: **5EI16PGTM2VBX**

All inserts have 2 cutting edges, except MiniTM (IC 6.0 mm) which has one edge.

For toolholder information, see page 234.

# ACME

## Internal

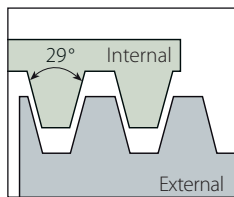

Defined by: ANSI B1/5:1988  
Tolerance class: 3G

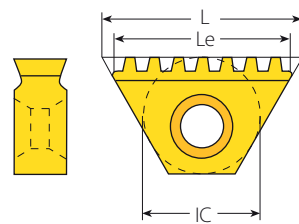

Coarse Pitch TM

## Coarse Pitch TM

Thread	Insert Size		Ordering Code	Cutting Edge	Le	Teeth	Toolholder	Bore Dia. Range
Inch	IC	L mm	Internal		mm			mm
1/2"-16	6.0mm	10.4	6.0116ACMETM...028/052	1	7.94	5	TMMC12-6.0	11.1
1/2"-16	6.0mm	10.4	6.0116ACMETM...028/052	1	7.94	5	TMMC20-6.0	11.1
5/8"-16	1/4"	11	2116ACMETM...028/053	2	9.53	6	TMC12-2	14.2
5/8"-16	1/4"	11	2116ACMETM...028/053	2	9.53	6	TMC20-2	14.2
5/8"-14	1/4"	11	2114ACMETM...028/054	1	9.07	5	TMC20-2 124/005	14.0
3/4"-16	1/4"	11	2116ACMETM...028/055	2	9.53	6	TMC12-2	17.4
3/4"-16	1/4"	11	2116ACMETM...028/055	2	9.53	6	TMC20-2	17.4
3/4"-14	1/4"	11	2114ACMETM...028/083	1	9.07	5	TMC20-2 124/006	17.2
3/4"-12	1/4"	11	2112ACMETM...028/056	1	8.47	4	TMC20-2 124/006	16.9
7/8"-14	3/8"	16	3114ACMETM...028/057	2	14.51	8	TMNC16-3	20.4
7/8"-12	1/4"	11	2112ACMETM...028/058	1	8.47	4	TMC20-2 124/006	20.1
1"-14	3/8"	16	3114ACMETM...028/059	2	14.51	8	TMC16-3	23.5
1"-12	3/8"	16	3112ACMETM...028/060	2	14.82	7	TMNC16-3	23.2
1"-10	1/2"	22	4110ACMETM...028/061	1	17.78	7	TMC25-4 124/002	22.8
1"-8	1/2"	22	418ACMETM...028/062	1	19.05	6	TMC25-4 124/002	22.2
1 1/8"-12	3/8"	16	3112ACMETM...028/060	2	14.82	7	TMC16-3	26.4
1 1/8"-10	1/2"	22	4110ACMETM...028/084	1	17.78	7	TMC25-4 124/007	26.0
1 1/8"-8	1/2"	22	418ACMETM...028/063	1	19.05	6	TMC25-4 124/002	25.4-28.5
1 1/4"-12	3/8"	16	3112ACMETM...028/060	2	14.82	7	TMC20-3	29.6
1 1/4"-10	5/8"	27	5110ACMETM...028/064	2	22.86	9	TMC25-5 124/004	29.2
1 1/4"-8	1/2"	22	418ACMETM...028/063	1	19.05	6	TMC25-4 124/002	25.4-28.5
1 3/8"-10	5/8"	27	5110ACMETM...028/065	2	22.86	9	TMC25-5 124/004	32.3
1 3/8"-8	5/8"	27	518ACMETM...028/066	2	22.23	7	TMC25-5 124/004	31.7
1 3/8"-6	5/8"	27	516ACMETM...028/067	1	21.17	5	TMC25-5 124/008	30.6
1 1/2"-10	5/8"	27	5110ACMETM...028/068	2	22.86	9	TMC25-5	35.5
1 1/2"-8	5/8"	27	518ACMETM...028/069	2	22.23	7	TMC25-5 124/004	34.9
1 1/2"-6	5/8"	27	516ACMETM...028/070	2	21.17	5	TMC25-5 124/004	33.8
1 3/4"-10	5/8"	27	5110ACMETM...028/064	2	22.86	9	TMC32-5	41.9
1 3/4"-8	5/8"	27	518ACMETM...028/069	2	22.23	7	TMC25-5	41.2
1 3/4"-6	5/8"	27	516ACMETM...028/070	2	21.17	5	TMC25-5	40.2
1 3/4"-5	5/8"	27	515ACMETM...028/071	2	20.32	4	TMC25-5 124/004	39.3
2"-8	5/8"	27	518ACMETM...028/069	2	22.23	7	TMC32-5	47.6
2"-6	5/8"	27	516ACMETM...028/072	2	21.17	5	TMC25-5	46.5
2"-5	5/8"	27	515ACMETM...028/071	2	20.32	4	TMC25-5	45.7
2 1/4"-6	5/8"	27	516ACMETM...028/072	2	21.17	5	TMC32-5	52.9
2 1/4"-5	5/8"	27	515ACMETM...028/073	2	20.32	4	TMC25-5	52.0
2 1/2"-5	5/8"	27	515ACMETM...028/073	2	20.32	4	TMC32-5	58.4

Sample tool requirement for thread ACME 1 3/4"-5

Ordering Code: Insert: 515ACME VBX 028/071 Toolholder: TMC25-5 124/004

For toolholder information, see page 234.



# TR

## Internal

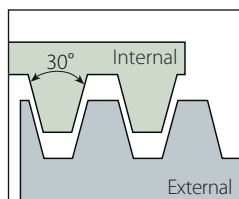

Defined by: Trapez DIN 103  
 Tolerance class: 7e/7H

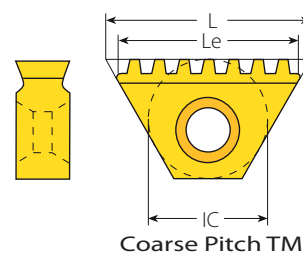

## Coarse Pitch TM

Thread	Insert Size		Ordering Code	Cutting Edge	Le	Teeth	Toolholder	Bore Dia. Range
mm	IC	L mm	Internal		mm			mm
TR 16X2.0	1/4"	11	212.0TRTM...028/028	1	10	5	TMC20-2 124/006	14.0
TR 18X2.0	1/4"	11	212.0TRTM...028/029	1	10	5	TMC20-2 124/006	16.0-18.0
TR 20X2.0	1/4"	11	212.0TRTM...028/029	1	10	5	TMC20-2 124/006	16.0-18.0
TR 24X3.0	1/2"	22	413.0TRTM...028/030	1	18	6	TMC25-4 124/002	21.0
TR 26X3.0	1/2"	22	413.0TRTM...028/031	1	18	6	TMC25-4 124/002	23.0-27.0
TR 28X3.0	1/2"	22	413.0TRTM...028/031	1	18	6	TMC25-4 124/002	23.0-27.0
TR 30X3.0	1/2"	22	413.0TRTM...028/031	1	18	6	TMC25-4 124/002	23.0-27.0
TR 32X3.0	1/2"	22	413.0TRTM...028/032	1	18	6	TMC25-4 124/007	29.0-33.0
TR 34X3.0	1/2"	22	413.0TRTM...028/032	1	18	6	TMC25-4 124/007	29.0-33.0
TR 36X3.0	1/2"	22	413.0TRTM...028/032	1	18	6	TMC25-4 124/007	29.0-33.0
TR 38X3.0	5/8"	27	513.0TRTM...028/033	2	24	8	TMC25-5 124/004	35.0-39.0
TR 40X3.0	5/8"	27	513.0TRTM...028/033	2	24	8	TMC25-5 124/004	35.0-39.0
TR 42X3.0	5/8"	27	513.0TRTM...028/033	2	24	8	TMC25-5 124/004	35.0-39.0
TR 44X3.0	5/8"	27	513.0TRTM...028/033	2	24	8	TMC25-5	41.0-45.0
TR 46X3.0	5/8"	27	513.0TRTM...028/033	2	24	8	TMC25-5	41.0-45.0
TR 48X3.0	5/8"	27	513.0TRTM...028/033	2	24	8	TMC25-5	41.0-45.0
TR 50X3.0	5/8"	27	513.0TRTM...028/033	2	24	8	TMC32-5	47.0-57.0
TR 52X3.0	5/8"	27	513.0TRTM...028/033	2	24	8	TMC32-5	47.0-57.0
TR 55X3.0	5/8"	27	513.0TRTM...028/033	2	24	8	TMC32-5	47.0-57.0
TR 60X3.0	5/8"	27	513.0TRTM...028/033	2	24	8	TMC32-5	47.0-57.0
TR 65X4.0	5/8"	27	514.0TRTM...028/034	2	24	6	TMC32-5	61.0-106.0
TR 70X4.0	5/8"	27	514.0TRTM...028/034	2	24	6	TMC32-5	61.0-106.0
TR 75X4.0	5/8"	27	514.0TRTM...028/034	2	24	6	TMC32-5	61.0-106.0
TR 80X4.0	5/8"	27	514.0TRTM...028/034	2	24	6	TMC32-5	61.0-106.0
TR 85X4.0	5/8"	27	514.0TRTM...028/034	2	24	6	TMC32-5	61.0-106.0
TR 90X4.0	5/8"	27	514.0TRTM...028/034	2	24	6	TMC32-5	61.0-106.0
TR 95X4.0	5/8"	27	514.0TRTM...028/034	2	24	6	TMC32-5	61.0-106.0
TR 100X4.0	5/8"	27	514.0TRTM...028/034	2	24	6	TMC32-5	61.0-106.0
TR 105X4.0	5/8"	27	514.0TRTM...028/034	2	24	6	TMC32-5	61.0-106.0
TR 110X4.0	5/8"	27	514.0TRTM...028/034	2	24	6	TMC32-5	61.0-106.0

Sample tool requirement for thread TR 38x3.0

Ordering Code: Insert: **513.0TRTM VBX 028/033** Toolholder: **TMC25-5 124/004**

For toolholder information, see page 234.





# Thread Milling



> Standard  
Toolholders

# THREAD MILLING TOOLHOLDERS

■ VARDEX Ordering Code System.....	Page 234
■ Standard Toolholder TM.....	Page 235
■ Long Shank Toolholder TML.....	Page 236
■ Coarse Pitch Toolholder 124/.....	Page 237
■ Taper Thread (NPT, NPTF, BSPT) Toolholder TMN.....	Page 237
■ Twin Flute Toolholder TM2.....	Page 238
■ Twin Flute Offset Toolholder TMO.....	Page 239
■ Standard Single Point TM Toolholder TMS.....	Page 240
■ Vertical Insert TM Toolholder TMV.....	Page 240
■ TM Shell Mill.....	Page 241
■ Spare Parts For VARDEX TM and TMSH Toolholders.....	Page 242

## VarDEX Ordering Code System

### Thread Milling Toolholders

<b>B</b>	<b>TM</b>	<b>N</b>	<b>C</b>	<b>20</b>	<b>-</b>	<b>3</b>	<b>B</b>		<b>LH</b>	
<b>1</b>	<b>2</b>	<b>3</b>	<b>4</b>	<b>5</b>		<b>6</b>	<b>7</b>	<b>8</b>	<b>9</b>	<b>10</b>
<b>1 - Shank Type</b>		<b>2 - System</b>			<b>3 - Holder Type</b>				<b>4 - Cooling</b>	
B - Anti Vibration System		TM - Thread Milling			2 - Twin Flute M - Mini L - Long Tool N - Tapered Holder V - Vertical Holder S - Single Point O - Offset W - Wide Cut. Dia.				C - Coolant Channel	
<b>5 - Shank Dia.</b>		<b>6 - Insert Size</b>		<b>7 - Cut. Edge Length</b>		<b>9 - RH / LH Holder</b>				
10, 12, 16, 20, 25, 32, 40		6.0 - 6.0mm 2 - 1/4" 3 - 3/8" 3B - 3/8"B 4 - 1/2" 5 - 5/8" 6B - 3/4"B		B - TMB		None - Right Hand LH - Left Hand				
				<b>8 - Serial No.</b>		<b>10 - Serial No.</b>				
				(for TMO Holders) 1 - 16		(for Coarse Pitch holders) 124/...				

### Thread Milling Shell Mill

<b>TMSH</b>	<b>-</b>	<b>D63</b>	<b>-</b>	<b>22</b>	<b>-</b>	<b>3</b>	<b>B</b>
<b>1</b>		<b>2</b>		<b>3</b>		<b>4</b>	<b>5</b>
<b>1 - System</b>		<b>2 - Cutting Dia.</b>		<b>3 - Drive Hole Dia.</b>		<b>4 - Insert Size</b>	
Thread Mill Shell Mill		38, 50, 63, 80, 100, 125		16, 22, 27, 32, 40		2 - 1/4" 3 - 3/8" 3B - 3/8"B 5 - 5/8" 6B - 3/4"B	
<b>5 - Cut. Edge Length</b>							
B - TMB							

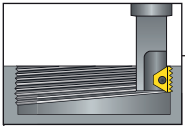

## External and Internal Toolholders

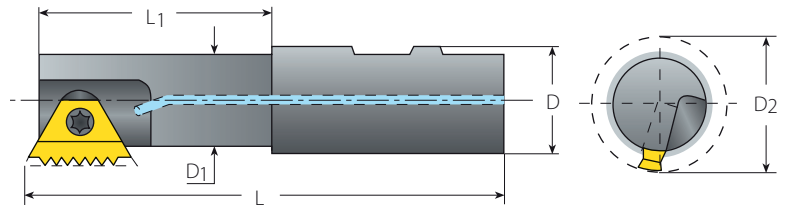
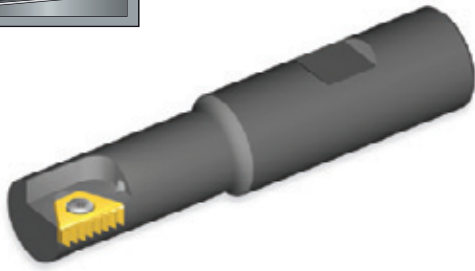

### TM Standard

### Spare Parts

Insert Size	Ordering Code	Dimensions mm					Spare Parts	
		L	L1	D	D1	D2	Insert Screw	Torx Key
6.0mm	TMMC12-6.0	69.0	12.0	12	6.8	9.0	SN7T	K7T
	TMMC20-6.0	84.0	17.0	20	6.8	9.0		
1/4"	TMC12-2	70.0	12.0	12	8.9	11.5	SN2TM	K2T
	TMC20-2	85.0	20.0	20	8.9	11.5		
3/8"	TMC16-3	90.0	22.0	16	13.6	17.0	SN3TM	K3T
	TMC20-3	95.0	43.0	20	16.6	20.0		
3/8"B	BTMC16-3B	79.5	29.0	16	13.5	17.0	SN3T	K3T
	BTMC20-3B	81.5	29.0	20	15.5	19.0		
	BTMC25-3B	92.3	30.0	25	15.5	19.0		
	BTMWC25-3B	90.8	30.0	25	18.5	22.0		
5/8"	TMC25-5	110.0	52.0	25	24.0	30.0	SN5TM	K5T
	TMC25-5LH	110.0	52.0	25	24.0	30.0		
	TMC32-5	120.0	58.0	32	31.0	37.0		
3/4"B	TMC32-6B	115.0	53.0	32	27.0	35.0	SM7T	K30T
	TMC40-6B	135.0	63.0	40	38.0	46.0		

Sample Order: TMC12-2

## External and Internal Toolholders

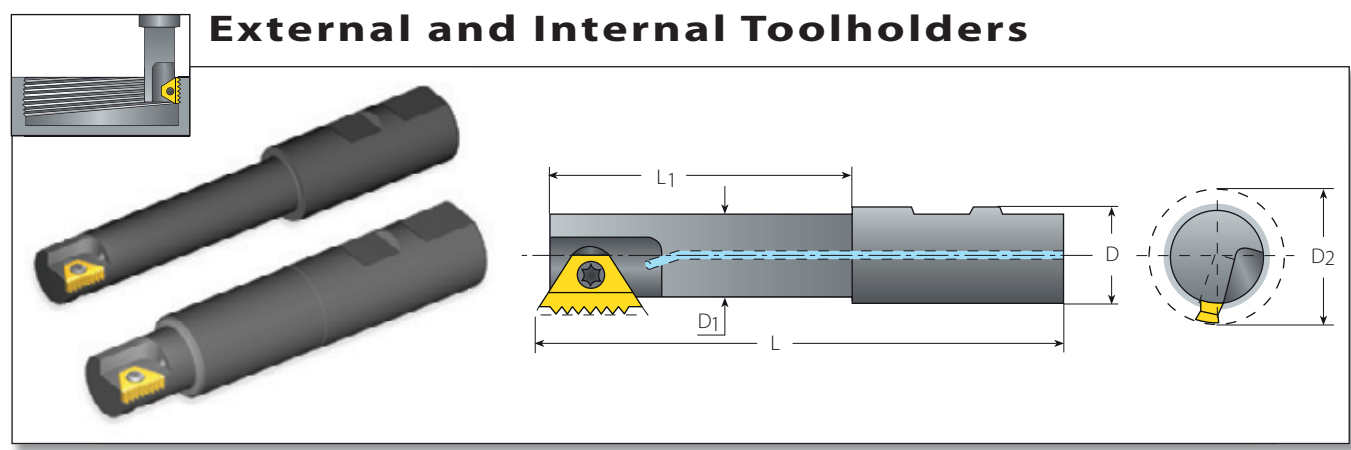

### TML Long Tools

### Spare Parts

Insert Size	Ordering Code	Dimensions mm					Spare Parts	
		L	L1	D	D1	D2	Insert Screw	Torx Key
1/4"	TMLC25-2	125.0	17.0	25	8.9	11.5	SN2TM	K2T
3/8"	TMLC25-3	125.0	25.0	25	18.6	22.0	SN3T	K3T
	BTMLC25-3	125.0	63.5	25	18.6	22.0		
3/8"B	BTMLC20-3B	96.5	44.0	20	15.5	19.0	SN3T	K3T
	BTMLC25-3B	125.0	63.5	25	18.6	22.0		
5/8"	TMLC25-5	150.0	92.0	25	24.0	30.0	SN5TM	K5T
	TMLC32-5	160.0	98.0	32	31.0	37.0		
3/4"B	TMLC40-6B	165.0	93.0	40	38.0	46.0	SM7T	K30T

Sample Order: TMLC25-3

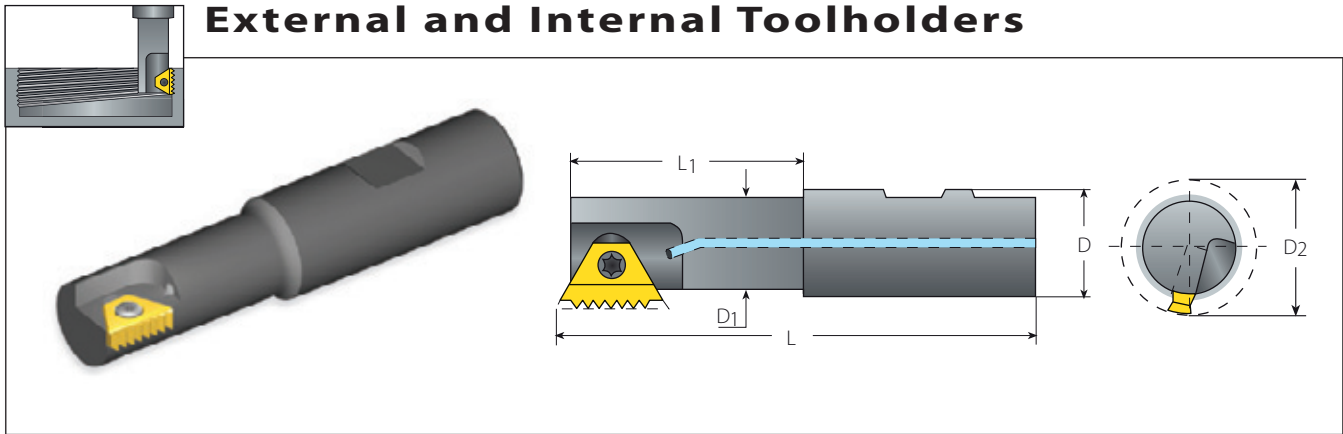

### 124/.. - For Coarse Pitch Threads

Spare Parts

Insert Size	Ordering Code	Dimensions mm					Spare Parts	
		IC	L	L1	D	D1	D2	Insert Screw
6.0mm	TMMC20-6.0 124/003	85	15.0	20	6.7	9.0	SN7T	K7T
	TMC20-2 124/005	77	15.5	20	7.4	10.0	SN2TM	K2T
1/4"	TMC20-2 124/006	77	15.5	20	9.0	12.0		
	TMC20-2 124/009	77	15.5	20	7.4	10.0		
3/8"	TMC16-3 124/001	91	20.5	16	12.2	15.5	SN3TM	K3T
1/2"	TMC25-4 124/002	88	30.0	25	13.4	18.0	SN4TM	K4T
	TMC25-4 124/007	98	40.0	25	16.0	20.0	SA4TM	
5/8"	TMC25-5 124/004	98	40.0	25	19.0	25.0	SA5TM	K5T
	TMC25-5 124/008	98	40.0	25	16.4	22.0	SN5TM	

Sample Order: TMMC 20-6 124/003

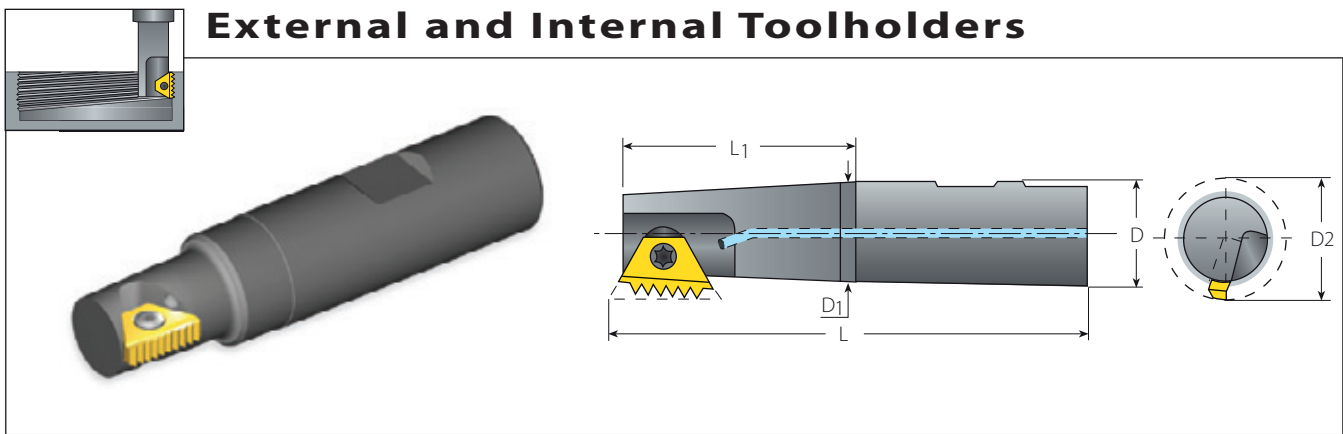

### TMN - For Conical Threads (NPT, NPTF, BSPT)

Spare Parts

Insert Size	Ordering Code		Dimensions mm					Spare Parts	
	IC	RH	LH	L	L1	D	D1	D2	Insert Screw
3/8"	TMNC16-3	TMNC16-3 LH	90.0	22.0	16	12.5	15.5	SN3TM	K3T
	TMNC20-3	TMNC20-3 LH	85.0	23.0	20	15.0	19.0		
3/8"B	BTMNC16-3B	BTMNC16-3B LH	79.5	29.0	16	13.5	17.0	SN3TM	K3T
	BTMNC20-3B	BTMNC20-3B LH	81.5	29.0	20	15.5	19.0		
5/8"	TMNC32-5	TMNC32-5 LH	120.0	58.0	32	31.0	37.0	SN5TM	K5T

Sample Order: TMNC20-3

**NOTE:** To use the cutting edge marked "L", LH Cutter is required. Add LH to the ordering code.

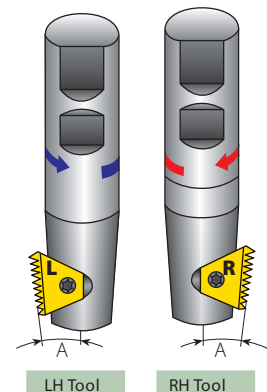

## External and Internal Toolholders

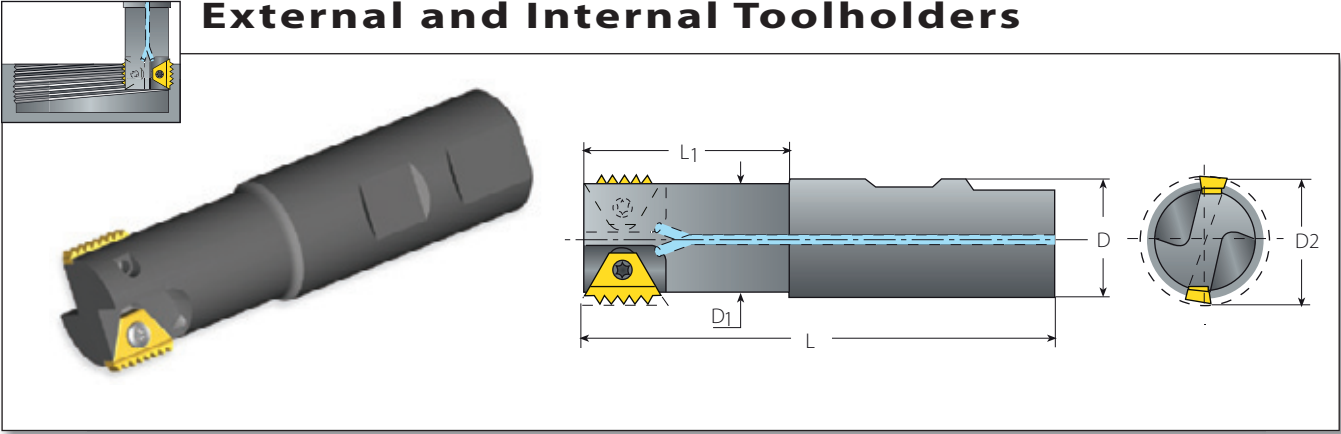

### TM2 - Twin Flutes

### Spare Parts

Insert Size	Ordering Code	Dimensions mm					Spare Parts	
		L	L1	D	D1	D2	Insert Screw	Torx Key
1/4"	TM2C20-2	85	20.0	20	14.4	17	SN2TM	K2T
3/8"	TM2C25-3	100	43.0	25	22.5	26	SN3T	K3T
3/8"B	BTM2C25-3B	104.2	46.0	25	22.5	26	SN5TM	K5T
5/8"	TM2C32-5	120	45.0	32	36.0	42	SM7T	K30T
3/4"B	TM2C40-6B	137.2	65.0	40	44.0	52		

Sample Order: **TM2C32-5**



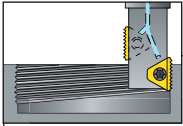

## External and Internal Toolholders

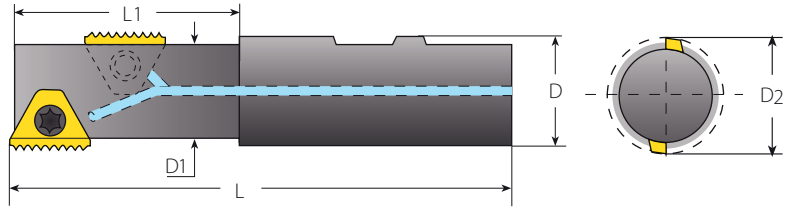
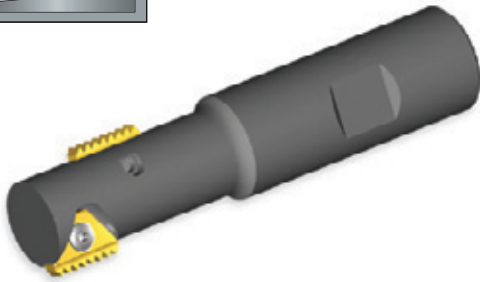

### TMO - Twin Flute Offset

Spare Parts

Insert Size	Ordering Code	Applicable Threads			Dimensions mm					Spare Parts	
		External	Internal	External & Internal	L	L1	D	D1	D2	Insert Screw	Torx Key
1/4"	TMOC20-2-1	16UN	48/32/16UN		90	25	20	11.9	14.5	SN2TM	K2T
	TMOC20-2-2	24/18UN	48/24/18UN	24W							
	TMOC20-2-3	28/14UN	28/14UN	28/14W							
	TMOC20-2-4	20UN	20UN								
	TMOC20-2-5			26W							
	TMOC20-2-6			20W							
	TMOC20-2-7			19W							
	TMOC20-2-8	1.0/1.5ISO	0.5/1.0/1.5ISO								
	TMOC20-2-9	0.75ISO	48UN, 0.75ISO								
	TMOC20-2-10	1.25ISO	1.25ISO								
3/8"	TMOC20-3-1	1.5ISO	0.5/1.5ISO		95	43	20	16.6	20	SN3T	K3T
	TMOC20-3-2	13UN	13UN	26W							
	TMOC20-3-3	28UN	32/28UN								
	TMOC20-3-4	27UN	27UN								
	TMOC20-3-5		11.5UN	11.5NPS							
	TMOC20-3-6	24/20/18/16/14/12UN	24/20/18/16/14/12UN	26/20/18/16/14/12W, 14NPS							
	TMOC20-3-7	1.25ISO	1.25ISO	24W							
	TMOC20-3-8			19W							
	TMOC20-3-9			11W							
	TMOC20-3-10	1.0/2.0ISO	0.5/1.0/2.0ISO								
	TMOC20-3-11	0.75ISO	32UN, 0.75ISO								
	TMOC20-3-12	1.75ISO	1.75ISO								
5/8"	TMOC25-5-1	24/20/18/14/13/12UN	24/20/18/14/13/11UN	14W	110	52	25	24	30	SN5TM	K5T
	TMOC25-5-2	24/18/12UN	24/18/12/6UN	12W							
	TMOC25-5-3	16UN	16UN	16W, 8NPS							
	TMOC25-5-4	14/7UN	14UN	14/7W							
	TMOC25-5-5		11.5UN	11.5NPS							
	TMOC25-5-6	11UN	11UN	11W							
	TMOC25-5-7	10UN	10/5UN	10W							
	TMOC25-5-8	9UN	9UN	9W							
	TMOC25-5-9	8UN	8UN	8W							
	TMOC25-5-10		7UN								
	TMOC25-5-11	6UN		6W							
	TMOC25-5-12	1.0/2.0/2.5/4.0ISO	1.0/2.0/2.5/4.0/5.0ISO								
	TMOC25-5-13	1.25ISO	1.25ISO								
	TMOC25-5-14	1.5/2.5/4.5ISO	1.5/2.5/4.5ISO								
	TMOC25-5-15	1.75ISO	1.75ISO								
	TMOC25-5-16	1.0/1.5/3.0/3.5ISO	1.0/1.5/3.0/3.5ISO								

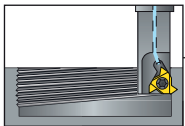

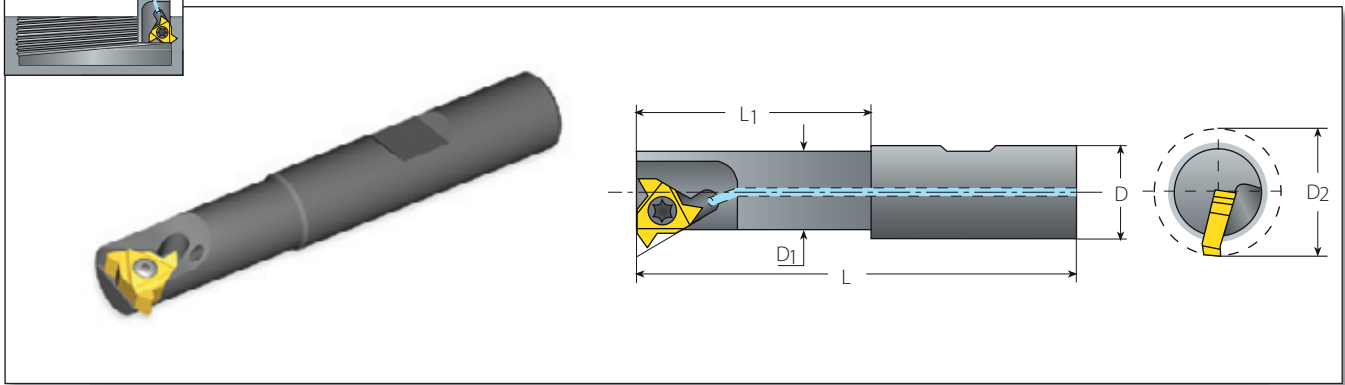

## External and Internal Toolholders



### TMS - Single Point (Standard Inserts)

Spare Parts

Insert Size	Ordering Code	Dimensions mm					Spare Parts	
IC		L	L1	D	D1	D2		
1/4"	TMSC10-2	65	25	10	9.3	12.5	SN2T8	K2T

Sample Order: **TMSC10-2**

**NOTE:** Use Standard laydown thread turning inserts. See Thread Turning Inserts section - Page 18.  
Use external LH inserts for external thread and internal RH inserts for internal thread.

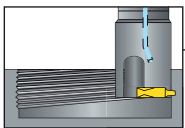

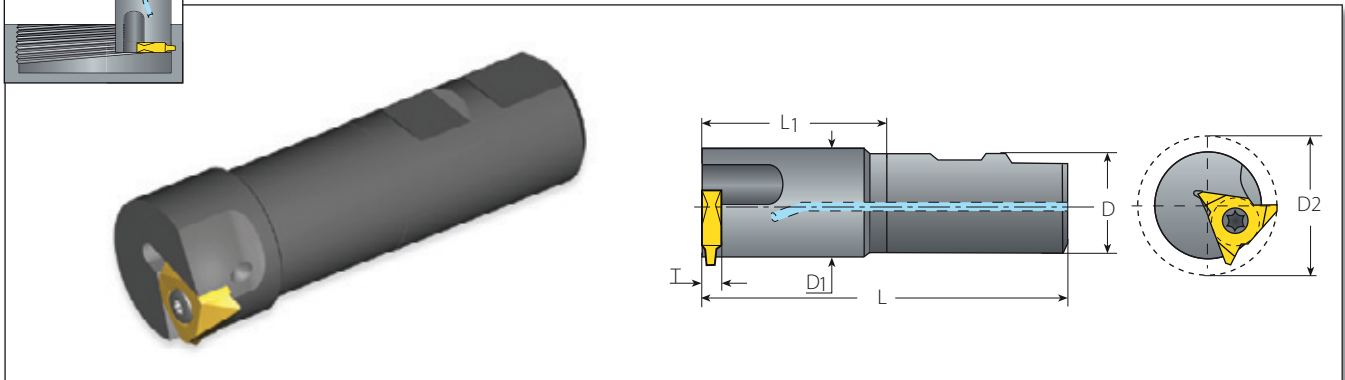

## External and Internal Toolholders



### TMV - Single Point (Vertical Insert)

Spare Parts

Insert Size	Ordering Code	Dimensions mm					Spare Parts	
IC		L	L1	D	D1	D2		
5/8"V	TMVC32-5	120	60	32	35.6	46	SN6T	K6T

Sample Order: **TMVC32-5**

**NOTE:** Requires IC 5/8" vertical thread turning inserts (width T=6). Use external LH inserts for external threads and internal RH inserts for internal threads.  
See Thread Turning Inserts section - Page 18.

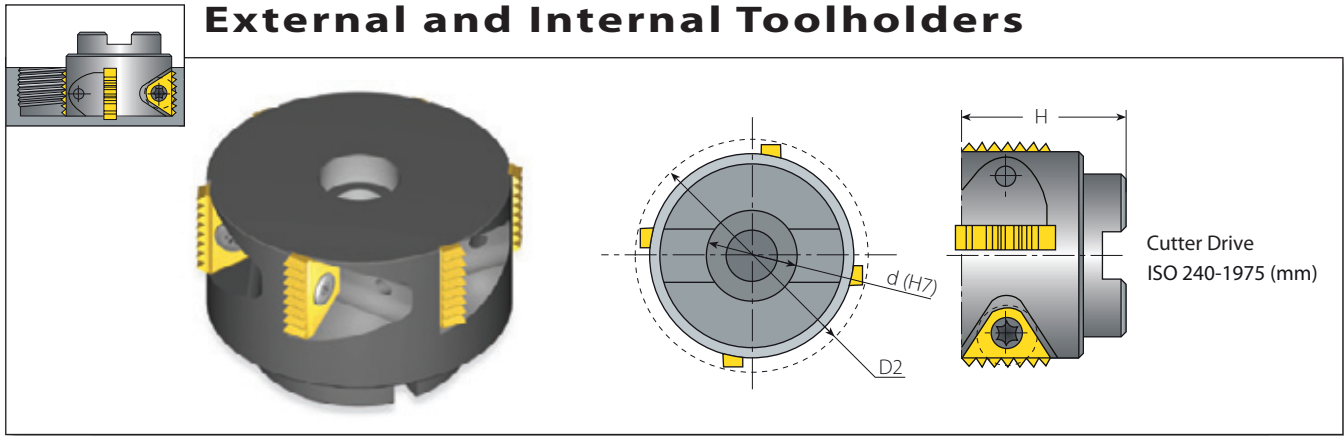

### TM Shell Mill

### Spare Parts

Insert Size	Ordering Code	No. of inserts	Dimensions mm			Spare Parts		
			D2	d(H7)	H	Insert Screw	Torx Key	Holder Screw
1/4"	TMSH-D38-16-2	6	38.0	16.0	40.0	SN2T	HK2T	M8X1.25X35 M10X1.50X35
1/4"	TMSH-D50-22-2	8	50.0	22.0	40.0	SN3TM	HK3T	M10X1.50X35 M10X1.50X35
3/8"	TMSH-D50-22-3	6	50.0	22.0	40.0		HK5T	M10X1.50X35
3/8B"	TMSH-D63-22-3B	6	63.0	22.0	40.0		HK7T	M10X1.50X35
5/8"	TMSH-D63-22-5	4	63.0	22.0	45.0	SN5TM	HK5T	M10X1.50X35
3/4B"	TMSH-D63-22-6B	4	63.0	22.0	50.0	SM7T	HK7T	M10X1.50X35
5/8"	TMSH-D80-27-5	6	80.0	27.0	50.0	SN5TM	HK5T	M12X1.75X40
3/4B"	TMSH-D80-27-6B	5	80.0	27.0	50.0	SM7T	HK7T	M12X1.75X40
5/8"	TMSH-D100-32-5	7	100.0	32.0	55.0	SN5TM	HK5T	M16X2.00X40
3/4B"	TMSH-D100-32-6B	6	100.0	32.0	55.0	SM7T	HK7T	M16X2.00X40
5/8"	TMSH-D125-40-5	9	125.0	40.0	63.0	SN5TM	HK5T	M20X2.50X50
3/4B"	TMSH-D125-40-6B	8	125.0	40.0	63.0	SM7T	HK7T	M20X2.50X50

## Spare Parts For VARDEX TM and TMSH Toolholders

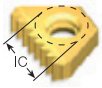

Insert IC



Holder



Holder Screw



Insert Screw



Torx Key

			Designation	Thread	
6.0mm	TMMC...-6.0		SN7T	M2.2x0.45x5.0	K7T
1/4"	TM.C...-2		SN2TM	M2.6x0.45x5.9	K2T
3/8"	TM.C...-3, TMC...-3 124/...		SN3T, SN3TM	UNC5x9.5, 8.0	K3T
3/8"B	BTM.C...-3B		SN3T	UNC5x.9.5	K3T
1/2"	TMC...-4 124/...		SN4TM, SA4TM	UNC8x10.7, 11.6	K4T
5/8"	TM.C...-5, TMC...-5 124/...		SN5TM, SA5TM	M5x0.8x15.0	K5T
3/4"B	TM.C...-6B		SM7T	M7x1.0x15.0	K30T
1/4"	TMSH-D38-16-2	M8X1.25X35	SN2T	M2.6x0.45x6.5	HK2T
1/4"	TMSH-D50-22-2	M10X1.50X35	SN2T	M2.6x0.45x6.5	HK2T
3/8"	TMSH-D50-22-3	M10X1.50X35	SN3TM	UNC5x8.0	HK3T
3/8"B	TMSH-D63-22-3B	M10X1.50X35	SN3TM	UNC5x8.0	HK3T
5/8"	TMSH-D63-22-5	M10X1.50X35	SN5TM	M5x0.8x15.0	HK5T
3/4"B	TMSH-D63-22-6B	M10X1.50X35	SM7T	M7x1.0x15.0	HK7T
5/8"	TMSH-D80-27-5	M12X1.75X40	SN5TM	M5x0.8x15.0	HK5T
3/4"B	TMSH-D80-27-6B	M12X1.75X40	SM7T	M7x1.0x15.0	HK7T
5/8"	TMSH-D100-32-5	M16X2.00X40	SN5TM	M5x0.8x15.0	HK5T
3/4"B	TMSH-D100-32-6B	M16X2.00X40	SM7T	M7x1.0x15.0	HK7T
5/8"	TMSH-D125-40-5	M20X2.50X50	SN5TM	M5x0.8x15.0	HK5T
3/4"B	TMSH-D125-40-6B	M20X2.50X50	SM7T	M7x1.0x15.0	HK7T



# Thread Milling

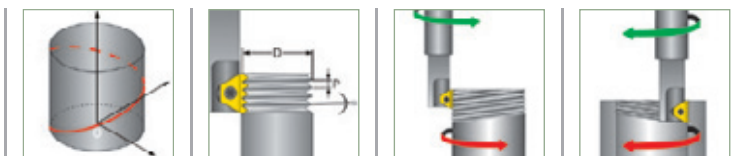

[> Technical Data](#)

# THREAD MILLING TECHNICAL DATA

■ About Thread Milling .....	Page 245
■ Tangential Arc Approach & Radial Approach .....	Page 246
■ Preparing for the Thread Milling Operation .....	Page 247
■ "G" Codes for CNC Program .....	Page 248
■ Grades and Their Applications .....	Page 248
■ Recommended Cutting Speeds .....	Page 249
■ Minimum Bore Diameters for Thread Milling .....	Page 250
■ Troubleshooting .....	Page 252

**For more Technical Data  
see our TM Handbook**



## About Thread Milling

In order to perform a thread milling operation, a milling machine with three-axis control capable of helical interpolation is required. Helical interpolation is a CNC function producing tool movement along a helical path. This helical motion combines circular movement in one plane with a simultaneous linear motion in a plane perpendicular to the first. For example, the path from point A to point B (Fig. A) on the envelope of the cylinder combines a circular movement in the xy plane with a linear displacement in the z direction.

On most CNC systems this function can be executed in two different ways:

**G02:** Helical interpolation in a clockwise direction

**G03:** Helical interpolation in a counter-clockwise direction

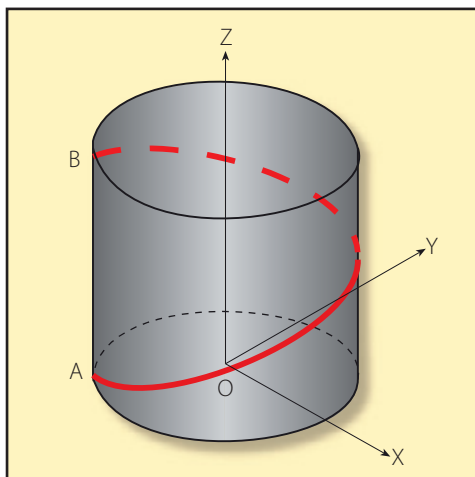

**Fig. A**

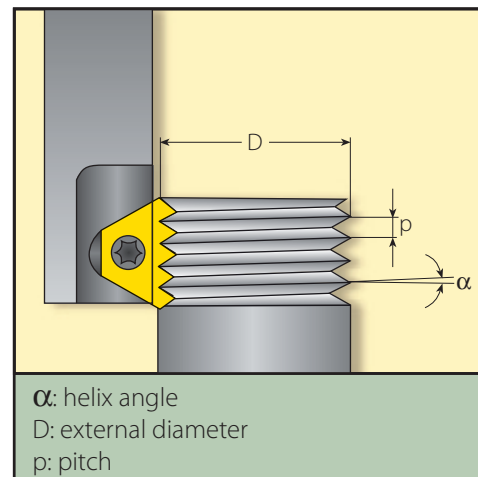

**Fig. B**

The thread milling operation (Fig. B) consists of circular rotation of the tool around its own axis together with an orbiting motion along the bore or workpiece circumference.

During one such orbit, the tool will shift vertically one pitch length. These movements combined with the insert geometry create the required thread form.

There are three acceptable ways of approaching the workpiece with the tool to initiate production of the thread:

- 1 Tangential Arc Approach**
- 2 Radial Approach**
- 3 Tangential Line Approach**

## 1 Tangential Arc Approach

With this method, the tool enters and exits the workpiece smoothly. No marks are left on the workpiece and there is no vibration, even with harder materials.

Although it requires slightly more complex programming than the radial approach (see below), this is the method recommended for machining the highest quality threads.

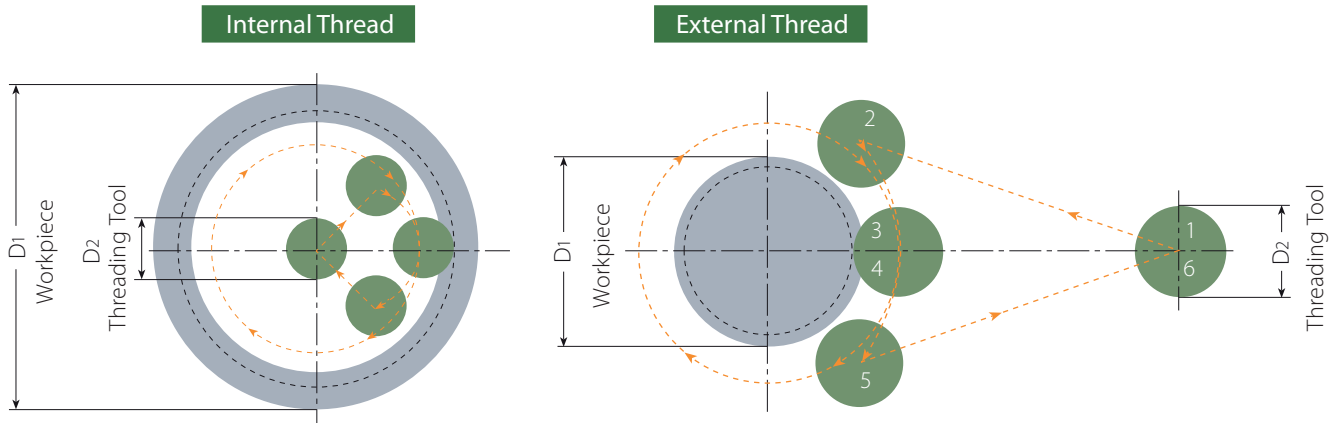

- 1-2:** Rapid approach
- 2-3:** Tool entry along tangential arc, with simultaneous feed along z-axis
- 3-4:** Helical movement during one full orbit (360°)
- 4-5:** Tool exit along tangential arc, with continuing feed along z-axis
- 5-6:** Rapid return

## 2 Radial Approach

This is the simplest method. There are two characteristics worth noting about the radial approach:

- A.** A small vertical mark may be left at the entry (and exit) point. This is of no significance to the thread itself.
  - B.** When using this method with very hard materials, there may be a tendency of the tool to vibrate as it approaches the full cutting depth.
- Note:** Radial feed during entry to the full profile depth should only be  $\frac{1}{3}$  of the subsequent circular feed !

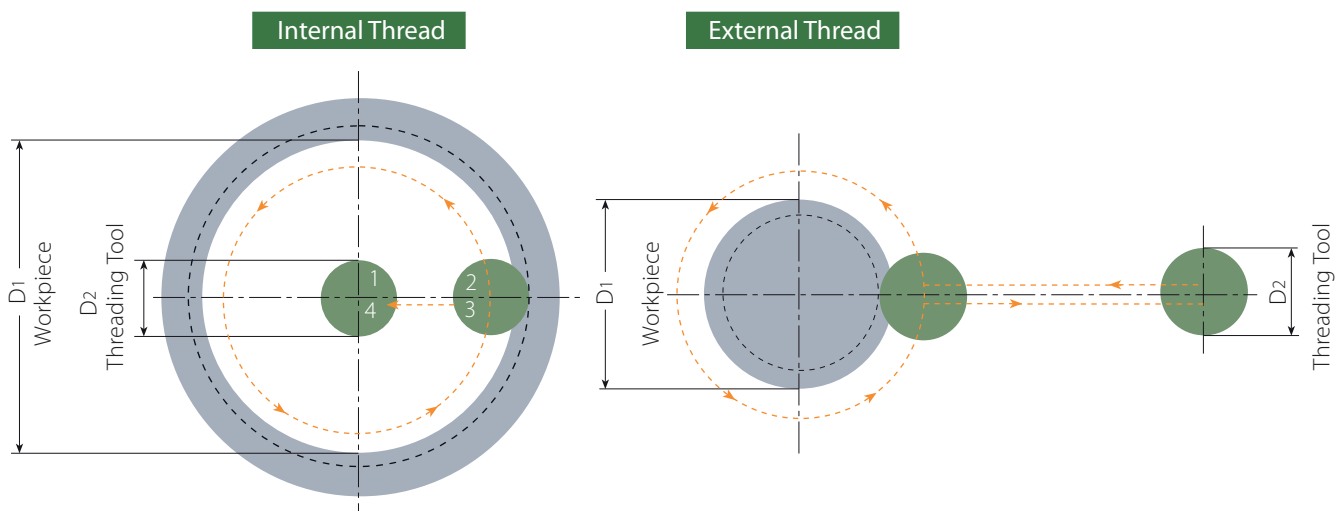

- 1-2:** Radial entry
- 2-3:** Helical movement during one full orbit (360°)
- 3-4:** Radial exit



### 3 Tangential Line Approach

This method is very simple, and has all of the advantages of the tangential arc method. However, it is applicable only with external threads.

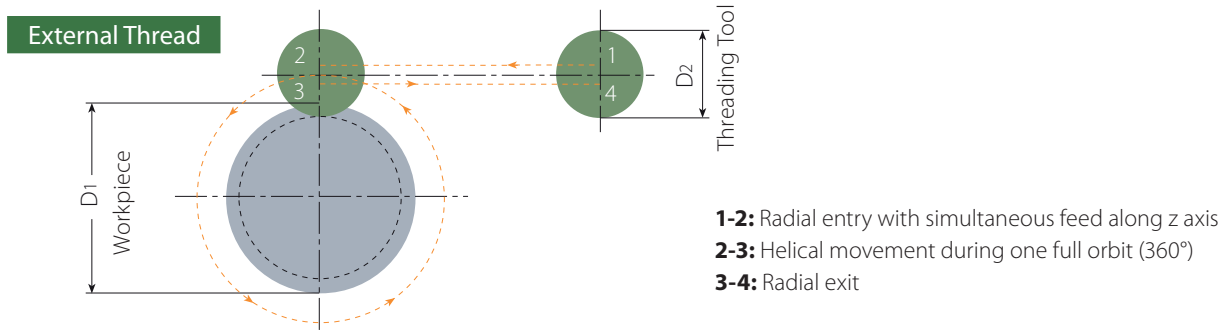

## Preparing for the Thread Milling Operation

### 1 Calculation of Rotational Velocity and Feed at the Cutting Edge

$$N = \frac{1000 \times V}{\pi \times D_2}$$

$$V = \frac{N \times \pi \times D_2}{1000}$$

$$F_1 = N \times z \times f$$

$N$  - Rotational Velocity [R.P.M.]  
 $V$  - Cutting Speed [m/min]  
 $D_2$  - Toolholder Cutting Dia. [mm]  
 $F_1$  - Tool Feed Rate at the Cutting Edge [mm/min]  
 $z$  - No. of Cutting Edges  
 $f$  - Feed per Tooth per Rotation [mm/tooth]

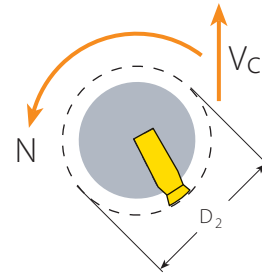

### 2 Calculation of Feed Rates at the Tool Center Line

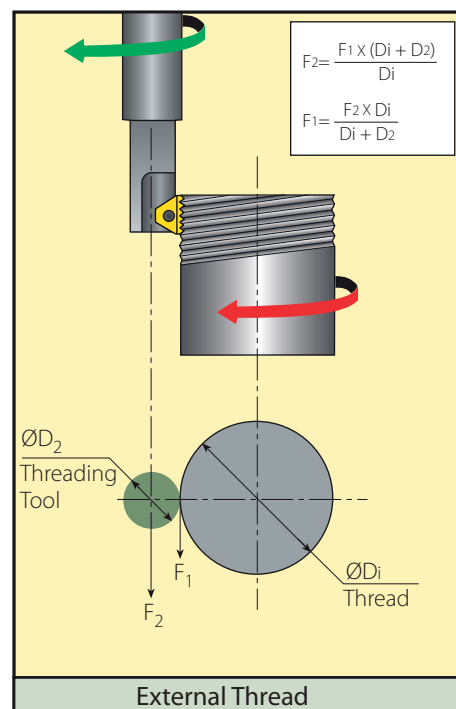
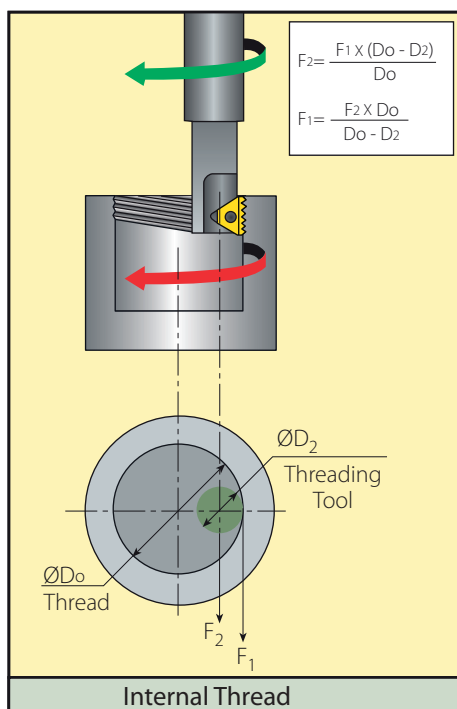



On most CNC machines, the feed rate required for programming is that of the center-line of the tool. When dealing with linear tool movement, the feed rate at the cutting edge and the center line are identical, but with circular tool movement, such is not the case. The equations define the relationship between feed rates at the cutting edge and at the tool center line.

## List of "G" Codes (ISO) for CNC Program

Code	Description	Code	Description
%	Recognition code (ISO or EIA), +End of tape	H	Tool length compensation number
G00	Fast feed linear positioning	D	Tool radius compensation number
G01	Linear interpolation	X	X coordinate
G02	Circular/Helical interpolation CW	Y	Y coordinate
G03	Circular/Helical interpolation CCW	Z	Z coordinate
G40	Cutter radius compensation cancel	R	Radius of travel
G41	Cutter radius compensation left	I	X coordinate to center of starting arc travel
G42	Cutter radius compensation right	J	Y coordinate to center of starting arc travel
G43	Tool length compensation +	M3	Spindle forward rotation
G49	Tool length compensation cancel	M5	Spindle stop
G57	Work coordinate system selection	M30	Program end & rewind
G90	Absolute command relative to work coordinate origin	O	Program number
G91	Incremental command relative to tool position	N	Block number (can be avoided)
F	Feed mm/min	(	Start of comment
S	Spindle speed RPM	)	End of comment

## Grades and Their Applications

Grade	Application	Sample
<b>VBX</b>	<b>First choice for steel and cast iron</b> A tough sub-micron substrate with TiCN coating Provides good fracture toughness and excellent wear resistance	
<b>VTX</b>	<b>First choice for stainless steel</b> A tough sub-micron substrate with TiAlN coating Provides good fracture toughness and excellent wear resistance	
<b>VK2</b>	Uncoated grade for machining cast iron & nonferrous metals	

## Recommended Grades, Cutting Speeds Vc [m/min] and Feed f [mm/tooth]

Material Group	Vardex No.	Material		Hardness Brinell HB	Vc [mm/min]			Feed f [mm/tooth]
					Coated		Uncoated	Indexable Inserts
					VBX	VTX	VK2	
<b>P</b> Steel	1	Unalloyed steel	Low carbon (C=0.1-0.25%)	125	100-210	90-180		0.05-0.3
	2		Medium carbon (C=0.25-0.55%)	150	100-180	90-170		0.05-0.25
	3		High Carbon (C=0.55-0.85%)	170	100-170	90-160		0.05-0.2
	4	Low alloy steel (alloying elements ≤5%)	Non hardened	180	90-160	90-155		0.05-0.25
	5		Hardened	275	80-180	80-160		0.05-0.2
	6		Hardened	350	70-140	70-150		0.05-0.15
	7	High alloy steel (alloying elements >5%)	Annealed	200	60-130	70-115		0.05-0.2
	8		Hardened	325	70-110	60-100		0.05-0.1
	9	Cast steel	Low alloy (alloying elements <5%)	200	100-170	100-170	100-150	0.05-0.15
	10		High alloy (alloying elements >5%)	225	70-120	70-130	60-130	0.05-0.1
<b>M</b> Stainless Steel	11	Stainless steel Ferritic	Non hardened	200	100-170	120-180		0.05-0.15
	12		Hardened	330	100-170	120-180		0.05-0.1
	13	Stainless steel Austenitic	Austenitic	180	70-140	100-140		0.05-0.15
	14		Super Austenitic	200	70-140	100-140		0.05-0.1
	15	Stainless steel Cast Ferritic	Non hardened	200	70-140	100-140		0.05-0.15
	16		Hardened	330	70-140	100-140		0.05-0.1
	17	Stainless steel Cast austenitic	Austenitic	200	70-120	100-120		0.05-0.15
	18		Hardened	330	70-120	100-120		0.05-0.1
<b>K</b> Cast Iron	28	Malleable Cast iron	Ferritic (short chips)	130	60-130	100-120		0.02-0.8
	29		Pearlitic (long chips)	230	60-120	80-100		0.02-0.05
	30	Grey cast iron	Low tensile strength	180	60-130	80-100		0.05-0.15
	31		High tensile strength	260	60-100	80-100		0.05-0.1
	32	Nodular SG iron	Ferritic	160	60-125	80-100		0.05-0.15
	33		Pearlitic	260	50-90	60-90		0.05-0.1
<b>N(K)</b> Non-Ferrous Metals	34	Aluminium alloys Wrought	Non aging	60	100-250		200-300	0.1-0.4
	35		Aged	100	100-180		60-110	0.1-0.3
	36	Aluminium alloys Cast	Cast	75	150-400		60-120	0.1-0.3
	37		Cast & aged	90	150-280		60-100	0.05-0.25
	38	Aluminium alloys Cast Si 13-22%	Cast Si 13-22%	130	80-150		20-50	0.1-0.3
	39	Copper and copper alloys	Brass	90	120-210	100-200	50-70	0.1-0.3
	40		Bronze and non leaded copper	100	120-210	100-200	50-70	0.05-0.25
<b>S(M)</b> Heat Resistant Material	19	High temperature alloys	Annealed (Iron based)	200	20-45	20-40	20-30	0.05-0.1
	20		Aged (Iron based)	280	20-30	20-30	15-25	0.02-0.05
	21		Annealed (Nickel or Cobalt based)	250	20-50	15-20	15-20	0.02-0.05
	22		Aged (Nickel or Cobalt based)	350	10-15	10-15	10-15	0.02-0.05
	23	Titanium alloys	Pure 99.5 Ti	400Rm	70-140	70-120	40-60	0.02--0.05
	24		α+β alloys	1050Rm	20-50	20-50	20-40	0.02-0.05
<b>H(K)</b> Hardned Material	25	Extra hard steel	Hardened & tempered	45-50HRc	20-45	20-45		0.01-0.03
	26			51-55HRc	20-45	20-45		0.01-0.02

### Recommendation:

At tool entry, set the Feed f [mm/tooth] to 70% lower than the threading Feed.

### Example:

Threading Feed: 0.3[mm/tooth]

Tool entry Feed: 0.09[mm/tooth]

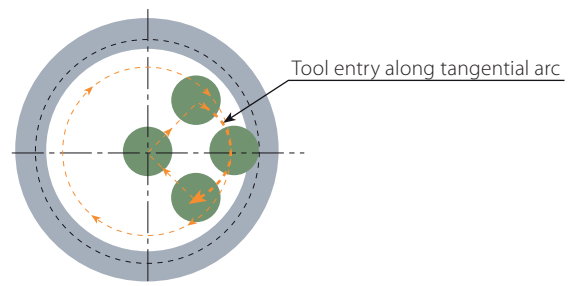

# Minimum Bore Diameters for Thread Milling

Pitch mm		0.5	0.6	0.7	0.75 0.80	0.9	1.0	1.25	1.5	1.75	2.0		2.5	3.0	3.5	4.0	4.5	5.0	5.5		6.0		
Pitch tpi		48	44	36	32	28	26 24	20 19	18 16	14	13 12	11.5 11	10	9 8	7	6		5		4.5		4	
Toolholder Ordering Code	D2	Minimum Bore Diameter Di mm																					
TMMC 12-6.0	9.0	9.5	9.7	9.9	10.0	10.4	10.7	11.4	12.0														
TMMC 20-6.0	9.0	9.5	9.7	9.9	10.0	10.4	10.7	11.4	12.0														
TMMC 20-6.0 124/003	9.0	9.5	9.7	9.9	10.0	10.4	10.7	11.4	12.0														
TMC 12-2	11.5	12.0	12.2	12.4	12.5	12.9	13.2	13.9	14.5	15.1													
TMC 20-2	11.5	12.0	12.2	12.4	12.5	12.9	13.2	13.9	14.5	15.1													
TMLC 25-2	11.5	12.0	12.2	12.4	12.5	12.9	13.2	13.9	14.5	15.1													
TMSC 10-2	12.5	13.0	12.6	13.6	13.5	13.9	14.2	14.9	15.5	16.1													
TMOOC 20-2	14.5	15.1	15.2	15.3	15.4	16.0	16.4	17.0	17.8	18.6													
TMNC 16-3	15.5	16.0	16.2	16.4	16.5	16.9	17.2	17.9	18.5	19.0	19.5	20.0											
TMC 16-3 124/001	15.5	16.0	16.2	16.4	16.5	16.9	17.2	17.9	18.5	19.0	19.5	20.0											
TMC 16-3	17.0	17.6	17.8	18.0	18.2	18.7	19.0	19.6	20.0	20.5	21.0	21.5											
BTMC 16-3B	17.0	17.6	17.8	18.0	18.2	18.7	19.0	19.6	20.0	20.5	21.0	21.5											
TM2C 20-2	17.0	17.6	17.8	18.0	18.2	18.7	19.0	19.6	20.0	20.5													
BTMC 20-3B	19.0	19.7	20.0	20.2	20.4	20.8	21.0	21.6	22.0	22.5	23.0	23.5											
TMNC 20-3	19.0	19.7	20.0	20.2	20.4	20.8	21.0	21.6	22.0	22.5	23.0	23.5											
TMC 20-3	20.0	20.7	21.0	21.2	21.4	21.8	22.0	22.6	23.0	23.5	24.0	24.5											
TMOOC 20-3	20.0	20.7	21.0	21.2	21.4	21.8	22.0	22.6	23.0	23.5	24.0	24.5											
BTMWC 25-3B	22.0	22.7	23.0	23.2	23.4	23.8	24.0	24.6	25.0	25.5	26.0	26.5											
BTMLC 25-3B	22.0	22.7	23.0	23.2	23.4	23.8	24.0	24.6	25.0	25.5	26.0	26.5											
TMLC 25-3	22.0	22.7	23.0	23.2	23.4	23.8	24.0	24.6	25.0	25.5	26.0	26.5											
TMC 25-5 124/004	25.0	25.7	26.0	26.2	26.4	26.8	27.0	27.7	28.2	28.7	29.2	29.7	31.3	33.7	36.7	39.7	42.7						
TM2C 25-3	26.0	26.7	27.0	27.2	27.4	27.8	28.0	28.7	29.3	29.8	30.3	30.8											
BTM2C 25-3B	26.0	26.7	27.0	27.2	27.4	27.8	28.0	28.7	29.3	29.8	30.3	30.8											
TMC 25-5	30.0	30.7	31.0	31.2	31.4	31.8	32.0	32.8	33.5	34.1	34.6	35.6	36.6	39.0	42.0	45.0	48.0						
TMLC 25-5	30.0	30.7	31.0	31.2	31.4	31.8	32.0	32.8	33.5	34.1	34.6	35.6	36.6	39.0	42.0	45.0	48.0						
TMOOC 25-5	30.0	30.7	31.0	31.2	31.4	31.8	32.0	32.8	33.5	34.1	34.6	35.6	36.6	39.0	42.0	45.0	48.0						
TMC 32-6B	35.0								38.5	39.1	39.6	40.6	42.0	44.0	47.0	50.0	53.4	42.5	50.0	44.6	57.5	56.6	
TMC 32-5	37.0	38.0	38.2	38.4	38.6	39.1	39.5	40.4	41.0	41.5	42.0	43.0	44.0	46.5	49.0	52.0	55.5						
TMLC 32-5	37.0	38.0	38.2	38.4	38.6	39.1	39.5	40.4	41.0	41.5	42.0	43.0	44.0	46.5	49.0	52.0	55.5						
TMNC 32-5	37.0	38.0	38.2	38.4	38.6	39.1	39.5	40.0	41.0	41.5	42.0	43.0	44.0	46.5	49.0	52.0	55.5						
TMSH D38-16-2	38.0	38.5	38.7	38.9	39.0	39.6	40.0	41.0	42.0	43.0													
TM2C 32-5	42.0	43.2	43.4	43.6	43.8	44.5	45.0	46.0	46.5	47.0	47.4	48.2	49.0	52.0	54.5	57.5	61.0						
TMVC 32-5	46.0																					62.5	
TMC 40-6B	46.0								49.5	50.1	50.6	51.6	53.0	55.0	55.2	55.6	55.0	52.5	54.0	54.5	57.5	56.6	
TMLC 40-6B	46.0								49.5	50.1	50.6	51.6	53.0	55.0	55.2	55.6	55.0	52.5	54.0	54.5	57.5	56.6	
TMSH D50-22-2	50.0	50.5	50.7	50.9	51.0	51.6	52.0	53.0	54.0	54.5													
TMSH D50-22-3	50.0	50.5	50.7	50.9	51.0	51.6	52.0	53.0	54.0	54.5	55.0	55.5											

Thread Milling  
Technical Data

## Minimum Bore Diameters for Thread Milling (con't)

Pitch mm	0.5	0.6	0.7	0.75 0.80	0.9	1.0	1.25	1.5	1.75	2.0		2.5	3.0	3.5	4.0	4.5	5.0	5.5		6.0		
Pitch tpi	48	44	36	32	28	26 24	20 19	18 16	14	13 12	11.5 11	10	9 8	7	6		5		4.5		4	
Toolholder Ordering Code	D2	Minimum Bore Diameter Di mm																				
TM2C 40-6B	52.0								56.0	56.2	56.5	57.0	59.0	61.5		63.0	64.0	66.0	67.0	67.6	69.0	70.0
TMSH D63-22-3B	63.0	63.5	63.7	63.9	64.0	64.6	65.0	66.0	67.0	67.5	68.0	69.0										
TMSH D63-22-5	63.0	63.5	63.7	63.9	64.0	64.6	65.0	66.0	67.0	67.5	68.0	69.0	70.0	72.0	73.0	74.0	75.0					
TMSH D63-22-6B	63.0								67.0	67.5	68.0	69.0	70.0	72.0	73.0	74.0	75.0	77.0	78.0	78.6	80.0	81.0
TMSH D80-27-5	80.0	80.5	80.7	80.9	81.0	81.6	82.0	83.0	84.0	84.5	85.0	86.0	87.0	89.0	90.0	91.0	92.0					
TMSH D80-27-6B	80.0								84.0	84.5	85.0	86.0	87.0	89.0	90.0	91.0	92.0	94.0	95.0	95.6	97.0	98.0
TMSH D100-32-5	100.0	100.5	100.7	100.9	101.0	101.6	102.0	103.0	104.0	104.5	105.0	106.0	107.0	109.0	110.0	111.0	112.0					
TMSH D100-32-6B	100.0								104.0	104.5	105.0	106.0	107.0	109.0	110.0	111.0	112.0	114.0	115.0	115.6	117.0	118.0
TMSH D125-40-5	125.0	125.5	125.7	125.9	126.0	126.6	127.0	128.0	129.0	129.5	130.0	131.0	132.0	134.0	135.0	136.0	137.0					
TMSH D125-40-6B	125.0								129.0	129.5	130.0	131.0	132.0	134.0	135.0	136.0	137.0	139.0	140.0	140.6	142.0	143.0

**Coarse Pitch Tooling:**

This table is not applicable to the Coarse Pitch system, which can thread mill bores smaller than those listed above. See the Coarse Pitch section of the various thread standards.

# Troubleshooting

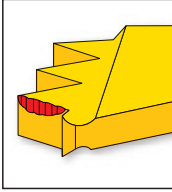
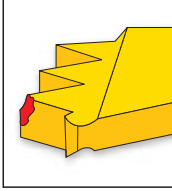
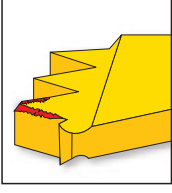
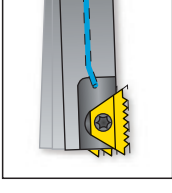
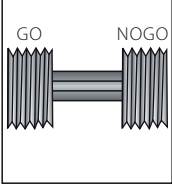
	Problem	Possible Cause	Solution
	<b>Increased insert flank wear</b>	Cutting speed too high -----> Chip is too thin -----> Insufficient coolant ----->	Reduce cutting speed/use coated insert Increase feed rate Increase coolant flow rate
	<b>Chipping of cutting edge</b>	Chip is too thick -----> Vibration ----->	Reduce feed rate Use the tangential arc method Increase RPM Check stability
	<b>Material build up on the cutting edge</b>	Incorrect cutting speed -----> Unsuitable carbide grade ----->	Change cutting speed Use a coated carbide grade
	<b>Chatter / Vibration</b>	Feed rate is too high -----> Profile is too deep -----> Thread length is too long ----->	Reduce the feed Execute two passes, each with increased cutting depth Execute two passes, each cutting only half the thread length Execute two passes, each cutting only half the thread length
	<b>Insufficient thread accuracy</b>	Tool deflection ----->	Reduce feed rate Execute a "zero" cut



# MiTM

Super Fast Thread Milling System



- > Inserts
- > Toolholders
- > Technical Data

# MiTM - MULTI-FLUTE INDEXABLE THREAD MILLING

■ VARDEX Ordering Code System.....	Page 256
------------------------------------	----------

## Inserts

■ ISO Metric.....	Page 257
■ American UN.....	Page 258
■ NPT.....	Page 259
■ NPTF.....	Page 259
■ Whitworth for BSF, BSP.....	Page 260
■ BSPT.....	Page 261

## Toolholders

■ Standard Toolholders (MiTM 24).....	Page 262
■ Conical Toolholders (MiTM 24).....	Page 263
■ Standard Toolholders (MiTM 25).....	Page 264
■ Conical Toolholders (MiTM 25).....	Page 265
■ Shell Mill (MiTM 25).....	Page 266
■ Standard Toolholders (MiTM 40).....	Page 267
■ Shell Mill (MiTM 40).....	Page 268
■ Standard Toolholders (MiTM 41).....	Page 269
■ Shell Mill (MiTM 41).....	Page 270

## Technical Data

■ Recommended Cutting Speeds and Feed.....	Page 271
--	----------



TM Gen Software and updated versions can be downloaded from [www.vargus.com](http://www.vargus.com)



# MiTM

## Comprehensive Family of Thread Milling Tools

The VARDEX Multi-flute Indexable Thread Mill (MiTM), reduces cycle time on machining of threads with long inserts in a variety of holder styles.

### MiTM 24 (M) For Small Bores

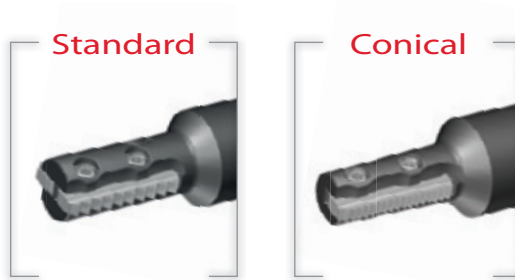

**Standard**  
No. of Flutes (Z) 1-2  
Cutting Dia. (D2) 13.6-16  
Tool Overhang (L1) 26-36

**Conical**  
No. of Flutes (Z) 1  
Cutting Dia. (D2) 13.9  
Tool Overhang (L1) 26

### MiTM 25 (S) For Standard Applications

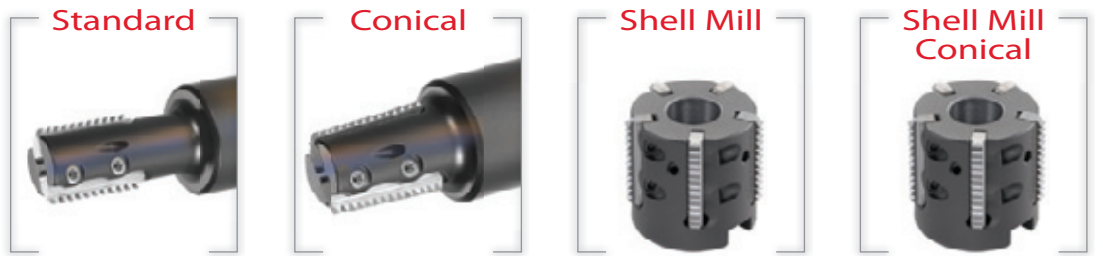

**Standard**  
No. of Flutes (Z) 2-5  
Cutting Dia. (D2) 17-30  
Tool Overhang (L1) 26-80

**Conical**  
No. of Flutes (Z) 2-4  
Cutting Dia. (D2) 17-28  
Tool Overhang (L1) 26-43

**Shell Mill**  
No. of Flutes (Z) 5-8  
Cutting Dia. (D2) 36-52  
Tool Overhang (L1) max.200

**Shell Mill Conical**  
No. of Flutes (Z) 5  
Cutting Dia. (D2) 36  
Tool Overhang (L1) max.200

### MiTM 40 (L) For Long Threads



**Standard**  
No. of Flutes (Z) 3-4  
Cutting Dia. (D2) 22-30  
Tool Overhang (L1) 43-80

**Shell Mill**  
No. of Flutes (Z) 6-8  
Cutting Dia. (D2) 44-52  
Tool Overhang (L1) max.200

**Shell Mill Conical**  
No. of Flutes (Z) 6  
Cutting Dia. (D2) 45  
Tool Overhang (L1) max.200

### MiTM 41 (B) For Large Pitches



**Standard**  
No. of Flutes (Z) 2-5  
Cutting Dia. (D2) 24.5-36  
Tool Overhang (L1) 43-65

**Shell Mill**  
No. of Flutes (Z) 5-6  
Cutting Dia. (D2) 48-58  
Tool Overhang (L1) max.200

MiTM

# MiTM Ordering Code System

## MiTM Inserts

<b>R</b>	<b>25</b>	<b>I</b>	<b>1.00</b>	<b>ISO</b>	<b>TM</b>	<b>VBX</b>
<b>1</b>	<b>2</b>	<b>3</b>	<b>4</b>	<b>5</b>	<b>6</b>	<b>7</b>
<b>1 - Product Line</b>	<b>2 - Insert Style</b>	<b>3 - Type of Insert</b>	<b>4 - Pitch</b>	<b>5 - Standard</b>	<b>6 - System</b>	<b>7 - Carbide Grade</b>
R- MiTM line	24, 25, 40, 41	I - Internal E - External EI-External+Internal NC- Plug	0.5-6.0 mm 32-4 tpi	ISO- ISO Metric UN-American UN W- BSW, BSP NPT-NPT NPTF-NPTF BSPT-BSPT	TM	VBX VTX

## MiTM Holders (Standard and Conical)

<b>R</b>	<b>TM</b>	<b>C</b>		<b>25</b>	<b>17</b>	<b>-</b>	<b>26</b>	<b>S</b>	<b>2</b>
<b>1</b>	<b>2</b>	<b>3</b>		<b>4</b>	<b>5</b>		<b>6</b>	<b>7</b>	<b>8</b>
<b>1 - Product Line</b>	<b>2 - Holder Type</b>	<b>3 - Cooling</b>		<b>4 - Shank Dia. [mm]</b>	<b>5 - Cutting Dia. [mm]</b>				
R - MiTM line BR - MiTM with anti vibration system	TM - Standard holder TMN - Conical holder	C- Coolant Channel		20, 25, 32	13.6 - 36				
<b>6 - Tool Overhang [mm]</b>	<b>7 - Insert Style</b>	<b>8 - No. of Flutes</b>							
26 - 80	M - 24 S - 25 L - 40 B - 41	1 - 5							

## MiTM Shell Mill

<b>R</b>	<b>TM</b>	<b>C</b>		<b>D36</b>	<b>16</b>	<b>-</b>	<b>25S</b>	<b>5</b>
<b>1</b>	<b>2</b>	<b>3</b>		<b>4</b>	<b>5</b>		<b>6</b>	<b>7</b>
<b>1 - Product Line</b>	<b>2 - Holder Type</b>	<b>3 - Cooling</b>		<b>4 - Cutting Dia. [mm]</b>	<b>5 - Drive Hole Dia. [mm]</b>			
R - MiTM line	TM - Standard holder TMN - Conical holder	C- Coolant Channel		36 - 58	16, 22, 27			
<b>6 - Insert Style</b>	<b>7 - No. of Flutes</b>							
25S 40L 41B	5 - 8							

# ISO Metric

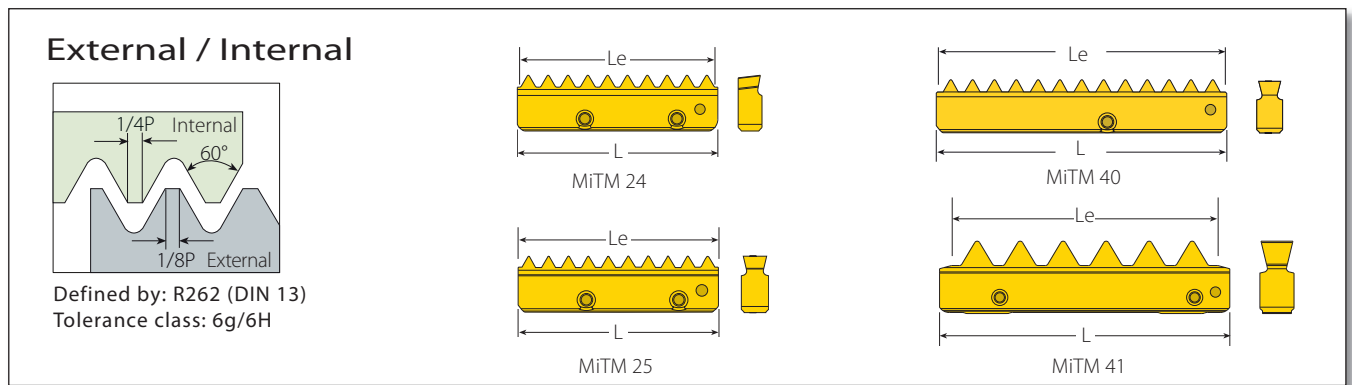

## Standard MiTM

	L mm	Pitch mm	Ordering Code		Cutting Edge	Le	Teeth Zt	Toolholder
			External	Internal				
	24	0.50		R24I0.50ISOTM...	1	24.50	49	RTMC...M
		0.75		R24I0.75ISOTM...	1	24.75	33	
		1.00		R24I1.00ISOTM...	1	24.00	24	
		1.25		R24I1.25ISOTM...	1	25.00	20	
		1.50		R24I1.50ISOTM...	1	24.00	16	
		1.75		R24I1.75ISOTM...	1	24.50	14	
		2.00		R24I2.00ISOTM...	1	24.00	12	
		2.50		R24I2.50ISOTM...	1	25.00	10	
	25	1.00	R25E1.00ISOTM...	R25I1.00ISOTM...	2	24.00	24	(B)RTMC...S
		1.50	R25E1.50ISOTM...	R25I1.50ISOTM...	2	24.00	16	
		2.00	R25E2.00ISOTM...	R25I2.00ISOTM...	2	24.00	12	
		2.50	R25E2.50ISOTM...	R25I2.50ISOTM...	2	25.00	10	
		3.00	*R25E3.00ISOTM...	*R25I3.00ISOTM...	2	24.00	8	
	40	1.00		R40I1.00ISOTM...	2	39.00	39	(B)RTMC...L
		1.50		R40I1.50ISOTM...	2	39.00	26	
		2.00		R40I2.00ISOTM...	2	38.00	19	
		2.50		R40I2.50ISOTM...	2	37.50	15	
		3.00		R40I3.00ISOTM...	2	39.00	13	
	41	3.00	R41E3.00ISOTM...	R41I3.00ISOTM...	2	39.00	13	RTMC...B
		3.50	R41E3.50ISOTM...	R41I3.50ISOTM...	2	38.50	11	
		4.00	R41E4.00ISOTM...	R41I4.00ISOTM...	2	40.00	10	
		4.50	R41E4.50ISOTM...	R41I4.50ISOTM...	2	40.50	9	
		5.00	R41E5.00ISOTM...	R41I5.00ISOTM...	2	40.00	8	
		5.50	R41E5.50ISOTM...	R41I5.50ISOTM...	2	38.50	7	
		6.00	R41E6.00ISOTM...	R41I6.00ISOTM...	2	36.00	6	

\* Note: 3.00 ISO inserts do not fit into toolholder RTMC2517...  
For external insert 3.0 ISO use for CNC program (D2 + 0.5mm)

MiTM inserts 25, 40 and 41 are offered with 2 cutting edges. In case of chip flow difficulty, inserts with a single cutting edge can be ordered by request. Example: R25I2.00ISOTM(S)...

MiTM

# American UN

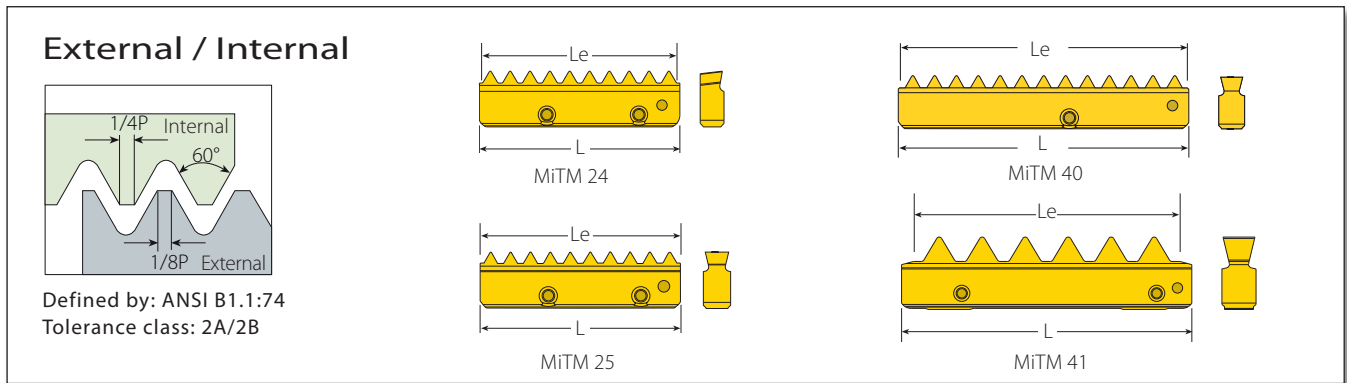

## Standard MiTM

L	Pitch	Ordering Code		Cutting Edge	Teeth	Toolholder	
		External	Internal				
24	32		R24I32UNTM...	1	24.61	31	
	28		R24I28UNTM...	1	24.49	27	
	24		R24I24UNTM...	1	24.34	23	
	20		R24I20UNTM...	1	24.13	19	
	18		R24I18UNTM...	1	23.99	17	RTMC...M
	16		R24I16UNTM...	1	23.81	15	
	14		R24I14UNTM...	1	23.59	13	
	12		R24I12UNTM...	1	23.28	11	
25	10		R24I10UNTM...	1	22.86	9	
	20	R25E20UNTM...	R25I20UNTM...	2	24.13	19	
	18	R25E18UNTM...	R25I18UNTM...	2	23.99	17	
	16	R25E16UNTM...	R25I16UNTM...	2	23.81	15	(B)RTMC...S
	14	R25E14UNTM...	R25I14UNTM...	2	23.58	13	
	12	R25E12UNTM...	R25I12UNTM...	2	23.28	11	
	10	R25E10UNTM...	R25I10UNTM...	2	22.86	9	
	9	*R25E9UNTM...	*R25I9UNTM...	2	22.58	8	* See note below
40	8	*R25E8UNTM...	*R25I8UNTM...	2	22.22	7	
	20		R40I20UNTM...	2	39.37	31	
	18		R40I18UNTM...	2	39.51	28	
	16		R40I16UNTM...	2	39.69	25	
	14		R40I14UNTM...	2	39.91	22	(B)RTMC...L
	12		R40I12UNTM...	2	38.10	18	
	10		R40I10UNTM...	2	38.10	15	
	9		R40I9UNTM...	2	39.51	14	
41	8		R40I8UNTM...	2	38.10	12	
	8	R41E8UNTM...	R41I8UNTM...	2	38.10	12	
	7	R41E7UNTM...	R41I7UNTM...	2	39.91	11	
	6	R41E6UNTM...	R41I6UNTM...	2	38.10	9	RTMC...B
	5	R41E5UNTM...	R41I5UNTM...	2	35.56	7	
	4.5	R41E4.5UNTM...	R41I4.5UNTM...	2	39.51	7	
	4	R41E4UNTM...	R41I4UNTM...	2	38.10	6	

\* Note: 8 UN & 9 UN inserts do not fit into toolholder RTMC2517...  
For external insert 8 UN use for CNC program (D2 + 0.5mm)

MiTM inserts 25, 40 and 41 are offered with 2 cutting edges. In case of chip flow difficulty, inserts with a single cutting edge can be ordered by request. Example: R25I20UNTM(S)...

# NPT

**External / Internal**

Defined by: USAS B2.1:1968  
Tolerance class: Standard NPT

## Standard MiTM

L mm	Pitch tpi	Ordering Code External + Internal	Cutting Edge	Le	Teeth Zt	Toolholder
24	18	R24EI18NPTTM...	1	23.99	17	RTMNC...M
	14	R25EI14NPTTM...	1	23.58	13	RTMNC...S
25	11.5	R25EI11.5NPTTM...	1	24.30	11	RTMNC-D36-16-25S5
	8	R25EI8NPTTM...	1	22.22	7	RTMNC-D36-16-25S5
40	11.5	R40EI11.5NPTTM...	1	37.55	17	RTMNC-D45-22-40L6
	8	R40EI8NPTTM...	1	38.10	12	RTMNC-D45-22-40L6
41	8	R41EI8NPTTM...	1	38.10	12	RTMC...B

# NPTF

**External / Internal**

Defined by: ANSI B1.20.3-1976  
Tolerance class: Standard NPTF

## Standard MiTM

L mm	Pitch tpi	Ordering Code External + Internal	Cutting Edge	Le	Teeth Zt	Toolholder
24	18	R24EI18NPTFTM...	1	23.99	17	RTMNC...M
	14	R25EI14NPTFTM...	1	23.58	13	RTMNC...S
25	11.5	R25EI11.5NPTFTM...	1	24.30	11	RTMNC-D36-16-25S5
	8	R25EI8NPTFTM...	1	22.22	7	RTMNC-D36-16-25S5
40	11.5	R40EI11.5NPTFTM...	1	37.55	17	RTMNC-D45-22-40L6
	8	R40EI8NPTFTM...	1	38.10	12	RTMNC-D45-22-40L6
41	8	R41EI8NPTFTM...	1	38.10	12	RTMC...B

MITM

# Whitworth for BSF, BSP

### External / Internal

Defined by: B.S.84:1956, DIN 259, ISO228/1:1982  
Tolerance class: Medium Class A

## Standard MiTM

	L	Pitch	Ordering Code		Cutting Edge	Teeth	Toolholder
	mm	tpi	External + Internal	Internal	Le	Zt	
	24	19	R24EI19WTM...		1	24.06	RTMC...M
		14	R24EI14WTM...		1	23.59	
		12	R24EI12WTM...		1	23.28	
	25	16	R25EI16WTM...		2	23.81	(B)RTMC...S
		14	R25EI14WTM...		2	23.58	
		12	R25EI12WTM...		2	23.28	
		11	R25EI11WTM...		2	23.09	
	40	16	R40EI16WTM...		2	39.69	(B)RTMC...L
		14	R40EI14WTM...		2	39.91	
		12	R40EI12WTM...		2	38.10	
		11	R40EI11WTM...		2	39.25	
	41	8		R41I8WTM...	2	38.10	RTMC...B
		7		R41I7WTM...	2	39.91	
		6		R41I6WTM...	2	38.10	

MiTM inserts 25, 40 and 41 are offered with 2 cutting edges. In case of chip flow difficulty, inserts with a single cutting edge can be ordered by request. Example: R25EI16WTM(S)...

# BSPT

**External / Internal**

Defined by: B.S. 21:1985  
Tolerance class: Standard BSPT

MiTM 24  
MiTM 40  
MiTM 25

## Standard MiTM

L	Pitch	Ordering Code	Cutting Edge	Teeth	Toolholder	
mm	tpi	External + Internal	Le	Zt		
24	19	R24EI19BSPTTM...	1	24.06	18	RTMNC 2014-26M1
25	14	R25EI14BSPTTM...	1	23.58	13	RTMNC...S
	11	R25EI11BSPTTM...	1	23.09	10	
40	11	R40EI11BSPTTM...	1	39.25	17	RTMNC-D45-22-40L6

## Plug Insert\*

L	Ordering Code	Teeth	Toolholder	
mm	External + Internal	Zt		
24	R24NC	No Teeth	RTMC...M	
25	R25NC		(B)RTMC...S	All Types
			RTMNC...S	
40	R40NC		(B)RTMC...L	
41	R41NC	RTMNC...L		
			RTMC...B	

\* Fill unused toolholder pockets with Plug inserts (R..NC). This assures balance and prevents instability and chips from packing into empty pockets.

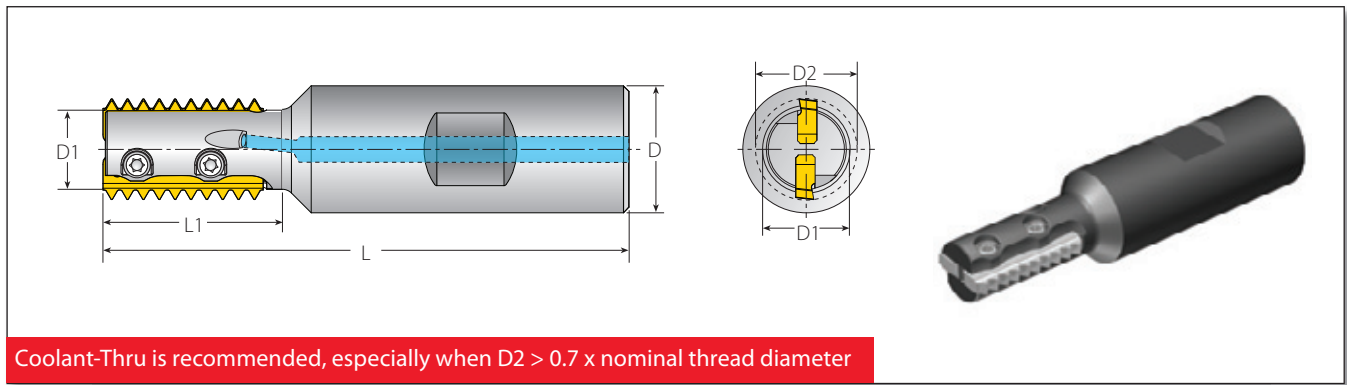

# Standard Toolholders (MiTM 24)



Coolant-Thru is recommended, especially when  $D2 > 0.7 \times$  nominal thread diameter

## RTMC - for Standard Threads

Spare Parts

Insert Style	Ordering Code	Dimensions (mm)						No. of Flutes		
mm		L	L1	D	D1	D2	Z	Location Screw x2	Torx+ Screwdriver	
24	RTMC 2013-26M1	82	26	20	10.7	13.6	1	SLD4IP8 (M4x0.7)	•Use the included Vardex Torx+ screwdriver only •Recommended max. torque 1.2 NxM	
	RTMC 2015-30M1	85	30	20	11.9	15.1	1			
	RTMC 2016-28M2	83	28	20	12.6	16	2			
	RTMC 2016-36M1	91	36	20	12.6	16	1			

## Standard Thread Application by Toolholder

Toolholder	Min. Thread Ø						
	D2 (mm)	ISO (coarse)	ISO (fine)	UNC	UN/UNF/UNEF/UNS	BSF	BSP(G)
RTMC 2013-26M1	13.6	M16x2	M14.5x0.5; M15X0.75; M15x1; M15x1.25; M16x1.5; M16x1.75	-	1/16-12UN; 3/16-14UNS; 5/16-16UN; 3/8-18UNF; 3/8-20UN; 3/8-24UNEF; 3/8-28UN; 3/8-32UN	1/16-14; 3/4-12	3/8-19
RTMC 2015-30M1	15.1	M18x2.5	M16x0.5; M17X0.75; M17x1; M17x1.25; M17x1.5; M18x1.75; M18x2	3/4-10	3/4-12UN; 3/4-14UNS; 1/16-16UN; 1/16-20UN; 1/16-24UNEF; 1/16-28UN; 1/16-32UN	3/4-12	-
RTMC 2016-28M2	16	M20x2.5	M17x0.5; M17x0.75; M18x1; M18x1.25; M18x1.5; M18x1.75; M19x2	3/4-10	3/4-12UN; 3/4-14UNS; 3/4-16UN; 3/4-18UNS; 3/4-20UNEF; 1/16-24UNEF; 1/16-28UN; 1/16-32UN	3/4-12	-
RTMC 2016-36M1	16	M20x2.5	M17x0.5; M17x0.75; M18x1; M18x1.25; M18x1.5; M18x1.75; M19x2	3/4-10	3/4-12UN; 3/4-14UNS; 3/4-16UN; 3/4-18UNS; 3/4-20UNEF; 1/16-24UNEF; 1/16-28UN; 1/16-32UN	3/4-12	-

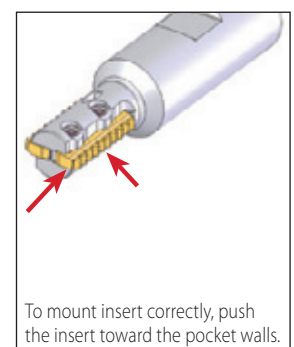
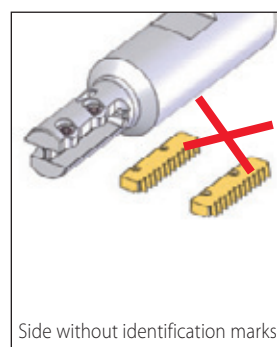
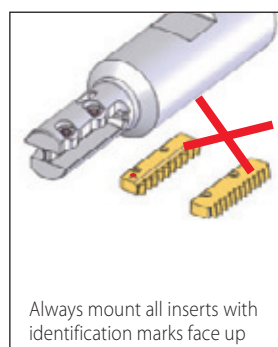
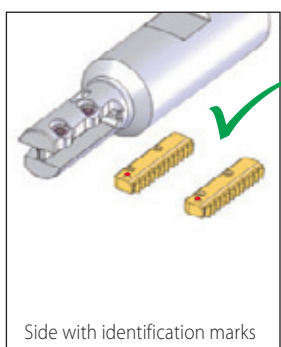



## Conical Toolholders (MiTM 24)

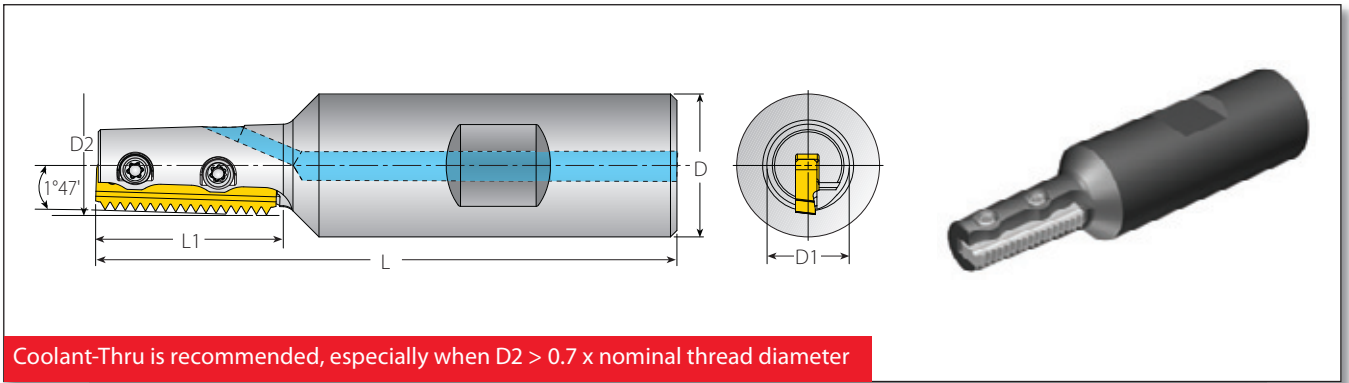

### RTMC - for Standard Threads

Insert Style	Ordering Code	Dimensions (mm)						No. of Flutes	Spare Parts	
		mm	L	L1	D	D1	D2		Z	
24	RTMNC 2014-26M1	81	26	20	11.5	13.9	1	SLD4IP8 (M4x0.7)	<b>KIP8</b> •Use the included Vardex Torx+ screwdriver only •Recommended max. torque 1.2 NxM	

### Standard Thread Application by Toolholder

Toolholder	D2 (mm)	NPT	NPTF	BSPT
		RTMNC 2014-26M1	13.9	$\frac{3}{8}$ -18

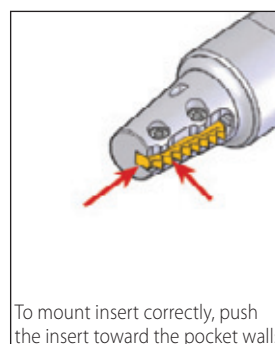
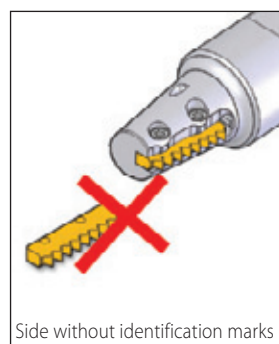
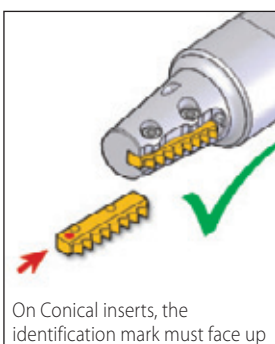

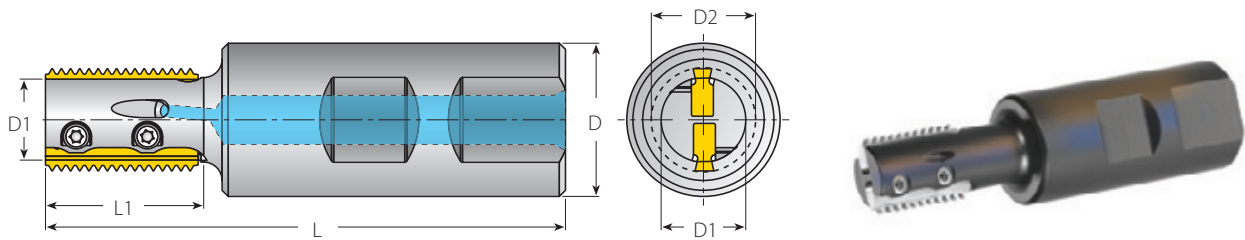

# Standard Toolholders (MiTM 25)



Coolant-Thru is recommended, especially when  $D2 > 0.7 \times$  nominal thread diameter

## RTMC - for Standard Threads

RTMC - for Standard Threads								Spare Parts	
Insert Style	Ordering Code	Dimensions (mm)			No. of Flutes				
mm		L	L1	D	D1	D2	Z	Location Screw x2	Torx+ Screwdriver
25	RTMC 2517-26S2	85	26	25	14	17	2	SLD4IP8 (M4x0.7)	<b>KIP8</b> •Use the included Vardex Torx+ screwdriver only •Recommended max. torque 1.2 NxM
	RTMC 2517-36S2	95	36			17	2		
	RTMC 2519-32S2	92	32			19	2		
	RTMC 2519-44S2	104	44			19	2		
	RTMC 2520-37S3	96	37			20.5	3		
	RTMC 2520-44S3	103	44			20.5	3		
	RTMC 2522-43S3	102	43			22	3		
	RTMC 2522-55S3	114	55			22	3		
	RTMC 2530-55S5	115	55			30	5		
	BRTMC 2530-80S4	140	80			30	4		

## Standard Thread Application by Toolholder

Toolholder	Min.Thread Ø						
	D2 (mm)	ISO (coarse)	ISO (fine)	UNC	UN/UNF/UNEF/UNS	BSF	BSP(G)
RTMC 2517-26S2	17	M20x2.5	M19x1; M19x1.5; M20x2	-	7/8-10UNS; 13/16-12UN; 7/8-14UNF;	7/8-11; 7/8-12; 7/8-14; 7/8-16	1/2-14
RTMC 2517-36S2					3/4-16UNF; 3/4-18UNS; 3/4-20UNEF		
RTMC 2519-32S2	19	M22x2.5 M24x3	M21x1; M21x1.5; M22x2	7/8-9; 1-8	7/8-20UNEF; 7/8-18UNS; 7/8-16UN;	7/8-16; 7/8-14; 15/16-12; 15/16-11	5/8-14
RTMC 2519-44S2					7/8-14UNF; 7/8-12UN; 7/8-10UNS		
RTMC 2520-37S3	20.5	M24x3	M22x1; M23x1.5; M23x2; M23.5x2.5	1-8	15/16-9UN; 1-10UNS; 15/16-12UN;	1-11; 1-12; 1-14; 1-16	5/8-14
RTMC 2520-44S3					1-14UNS; 15/16-16UN; 7/8-18UNS; 7/8-20UNEF		
RTMC 2522-43S3	22	M27x3	M24x1; M24x1.5; M25x2; M25x2.5	-	1 1/16-8UN; 1-9UN; 1-10UNS; 1-12UNF;	1-11; 1-12; 1-14; 1-16	3/4-14
RTMC 2522-55S3					1-14UNS; 1-16UN; 1-18UN; 15/16-20UNEF		
RTMC 2530-55S5	30	-	M32x1; M32x1.5; M33x2; M33x2.5; M34x3	-	1 3/8-8UN; 1 3/8-9UN; 1 3/8-10UN; 1 3/8-12UN;	1 3/8-11; 1 3/8-12; 1 3/8-14; 1 3/8-16	1-11
BRTMC 2530-80S4					1 3/8-14UNS; 1 3/8-16UN; 1 3/8-18UNEF; 1 3/8-20UN		

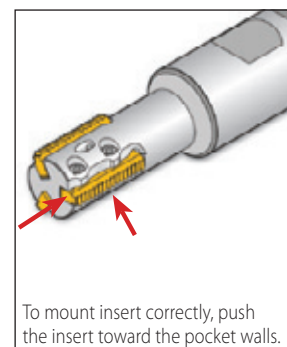
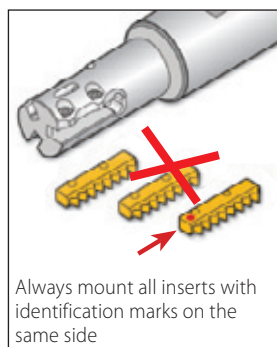
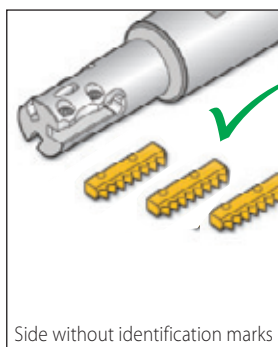
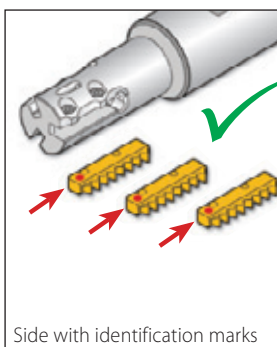

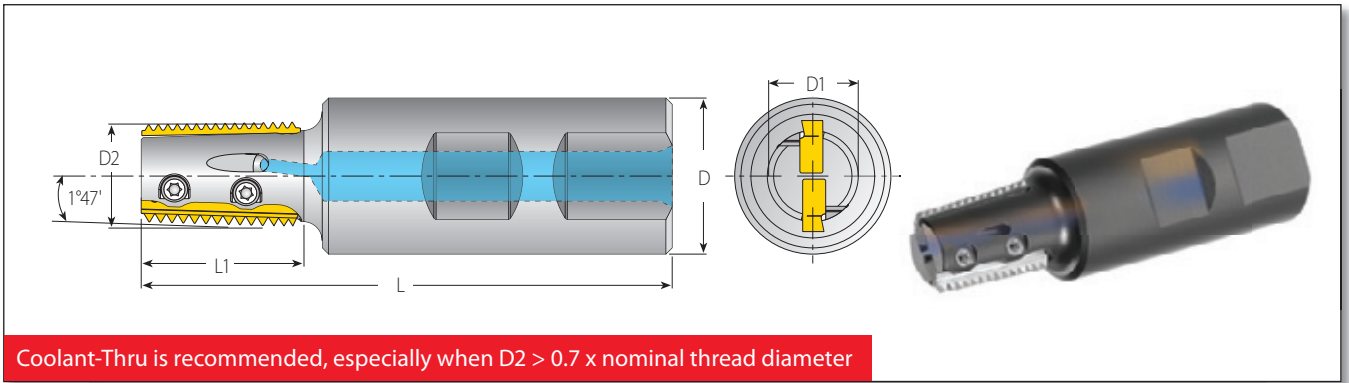

# Conical Toolholders (MiTM 25)



Coolant-Thru is recommended, especially when D2 > 0.7 x nominal thread diameter

## RTMNC - for Conical Threads

### Spare Parts

Insert Style	Ordering Code	Dimensions (mm)						No. of Flutes	Spare Parts	
		L	L1	D	D1	D2	Z			
mm		L	L1	D	D1	D2	Z	Location Screw x2	Torx+ Screwdriver	
25	RTMNC 2517-26S2	85	26	25	14	17	2	SLD4IP8 (M4x0.7)	<b>KIP8</b> • Use the included Vardex Torx+ screwdriver only • Recommended max. torque 1.2 Nm	
	RTMNC 2522-43S3	102	43	25	18	22	3			
	RTMNC 2528-43S4	103	43	25	26	28	4			

## Conical Thread Application by Toolholder

Toolholder	Thread Ø			
	D2(mm)	NPT	NPTF	BSPT
RTMNC 2517-26S2	17	½-14; ¾-14; 1-11.5; 1¼-11.5; 1½-11.5; 2-11.5	½-14; ¾-14; 1-11.5; 1¼-11.5; 1½-11.5; 2-11.5	½-14; ¾-14
RTMNC 2522-43S3	22	¾-14; 1-11.5; 1¼-11.5; 1½-11.5; 2-11.5	¾-14; 1-11.5; 1¼-11.5; 1½-11.5; 2-11.5	¾-14; 1-11; 1¼-11; 1½-11; 2-11; 2½-11; 3-11; 4-11; 5-11; 6-11
RTMNC 2528-43S4	28	1-11.5; 1¼-11.5; 1½-11.5; 2-11.5	1-11.5; 1¼-11.5; 1½-11.5; 2-11.5	1-11; 1¼-11; 1½-11; 2-11; 2½-11; 3-11; 4-11; 5-11; 6-11

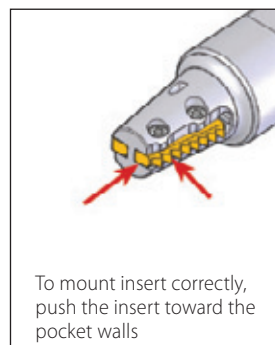
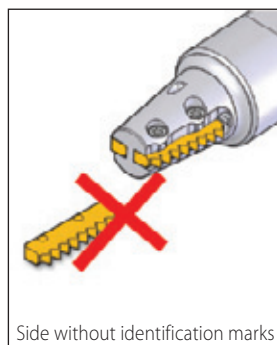
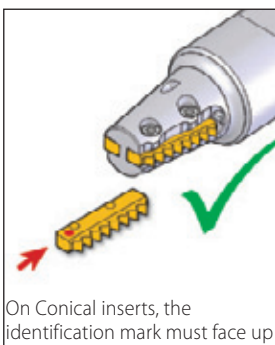

MITM

# Shell Mill (MiTM 25)

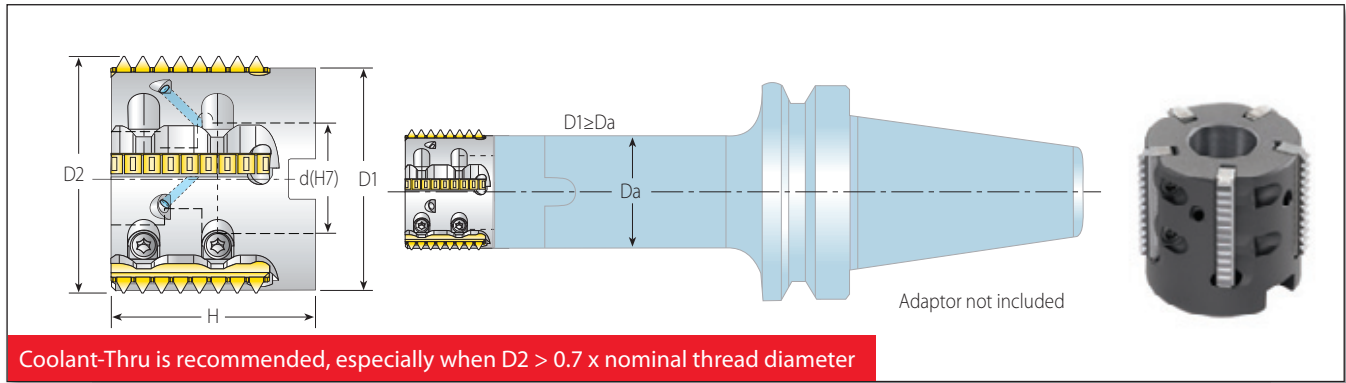

## Conical and Standard Shell Mills

## Spare Parts

Insert Style	Ordering Code	Dimensions (mm)					No. of Flutes			
mm		D1	D2	d(H7)	H	Z	Location Screw x2	Torx+ Screwdriver	Holder Screw	
Standard	25	RTMC D36-16-25S5	32	36	16	33.5	5	SLD4IP8 (M4x0.7)	KIP8 •Use the included Vardex Torx+ screwdriver only •Recommended max. torque 1.2 NxM	M8x1.25x30
		RTMC D44-22-25S6	40	44	22	38	6			M10x1.50x35
		RTMC D52-27-25S8	48	52	27	40	8			M12x1.75x30
Conical		RTMNC D36-16-25S5	32	36*	16	33.5	5			M8x1.25x30

\* For inserts 8NPT and 8NPTF use for CNC program (D2+0.6mm)

## Standard Thread Applications by Toolholder

Toolholder		Min. Thread Ø				
		D2(mm)	ISO (fine)	UN/UNF/UNEF/UNS	BSW	BSP(G)
Standard	RTMC D36-16-25S5	36	M38x1; M39x1.5; M39x2; M40x3	1 <sup>1</sup> / <sub>16</sub> -12UN; 1 <sup>1</sup> / <sub>8</sub> -14UNS; 1 <sup>1</sup> / <sub>16</sub> -16UN; 1 <sup>1</sup> / <sub>2</sub> -18UNEF; 1 <sup>1</sup> / <sub>2</sub> -20UN	1 <sup>3</sup> / <sub>4</sub> -16 1 <sup>3</sup> / <sub>4</sub> -12	1 <sup>1</sup> / <sub>4</sub> -11
	RTMC D44-22-25S6	44	M48x1; M48x1.5; M48x2; M48x3	1 <sup>7</sup> / <sub>8</sub> -12UN; 1 <sup>13</sup> / <sub>16</sub> -16UN; 1 <sup>13</sup> / <sub>16</sub> -20UN; 1 <sup>15</sup> / <sub>16</sub> -8UN; 1 <sup>7</sup> / <sub>8</sub> -10UNS; 1 <sup>7</sup> / <sub>8</sub> -14UNS	2-16 2-12	1 <sup>1</sup> / <sub>2</sub> -11
	RTMC D52-27-25S8	52	M55x1; M55x1.5; M55x2; M56x3	2 <sup>1</sup> / <sub>4</sub> -8UN; 2 <sup>1</sup> / <sub>4</sub> -10UN; 2 <sup>1</sup> / <sub>4</sub> -12UN; 2 <sup>1</sup> / <sub>4</sub> -14UN; 2 <sup>1</sup> / <sub>4</sub> -16UN; 2 <sup>1</sup> / <sub>4</sub> -18UN; 2 <sup>1</sup> / <sub>4</sub> -20UN	2 <sup>1</sup> / <sub>4</sub> -16 2 <sup>1</sup> / <sub>4</sub> -12	2-11

## Conical Thread Applications by Toolholder

Toolholder		Thread Ø			
		D2 (mm)	NPT	NPTF	BSPT
Conical	RTMNC D36-16-25S5	36	1 <sup>1</sup> / <sub>4</sub> -11.5; 1 <sup>1</sup> / <sub>2</sub> -11.5; 2-11.5 2 <sup>1</sup> / <sub>2</sub> -8 (and up)	1 <sup>1</sup> / <sub>4</sub> -11.5; 1 <sup>1</sup> / <sub>2</sub> -11.5; 2-11.5 2 <sup>1</sup> / <sub>2</sub> -8; 3-8	1 <sup>1</sup> / <sub>2</sub> -6x11

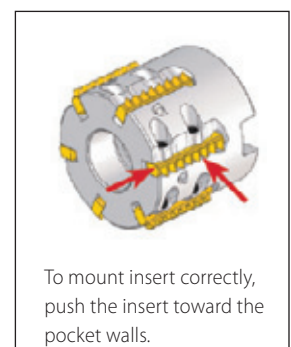
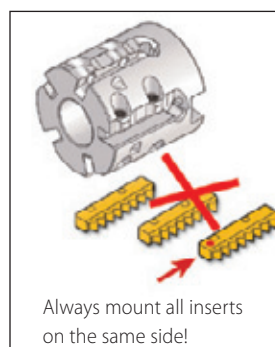
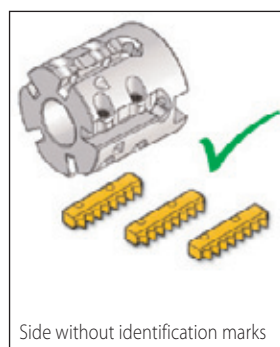
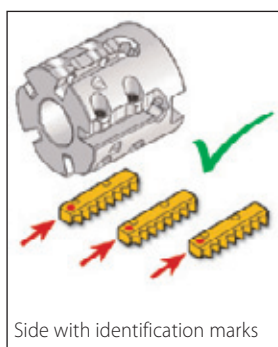

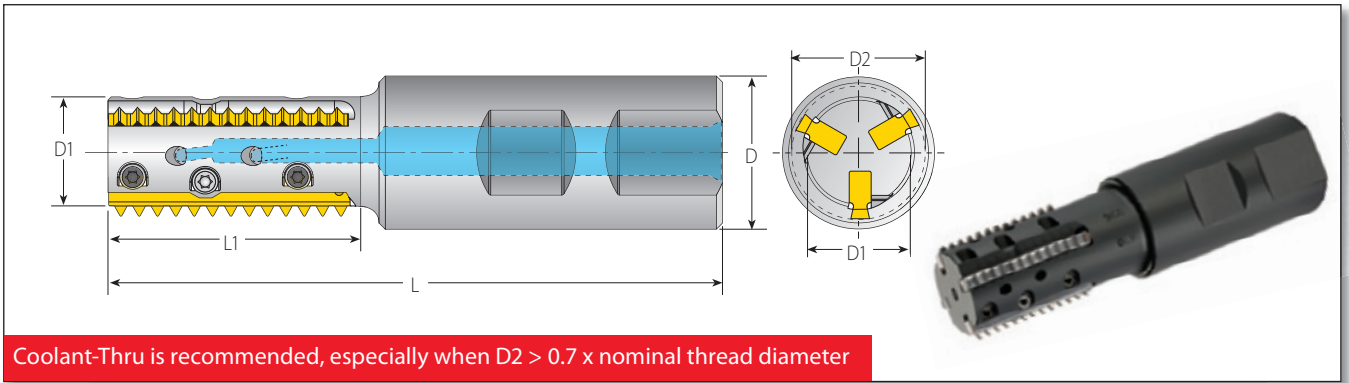

# Standard Toolholders (MiTM 40)



Coolant-Thru is recommended, especially when  $D2 > 0.7 \times$  nominal thread diameter

## RTMC - for Standard Threads

RTMC - for Standard Threads								Spare Parts		
Insert Style	Ordering Code	Dimensions (mm)					No. of Flutes			
mm		L	L1	D	D1	D2	Z	Location Screw	Clamping Screw x2	Torx+ Screwdriver
40	RTMC 2522-43L3	102	43	25	18	22	3	SLD4IP8A (M4x0.7)	SCD4IP8 (M4x0.7)	<b>KIP8</b> •Use the included Vardex Torx+ screwdriver only •Recommended max. torque 1.2 NxM
	RTMC 2522-65L3	124	65	25	18	22	3			
	RTMC 3230-55L4	117	55	32	26	30	4			
	BRTMC 3230-80L3	142	80	32	26	30	3			

## Standard Thread Application by Toolholder

Toolholder	Min. Thread Ø						
	D2 (mm)	ISO (coarse)	ISO (fine)	UNC	UN/UNF/UNEF/UNS	BSF	BSP(G)
RTMC 2522-43L3	22	M27x3	M24x1; M24x1.5 M25x2; M25x2.5	-	1 1/16-8UN; 1-9UN; 1-10UNS; 1-12UNF; 1-14UNS; 1-16UN; 1-18UN; 1 1/16-20UNEF	1-11; 1-12; 1-14; 1-16;	3/4-14
RTMC 2522-65L3	22	M27x3	M24x1; M24x1.5 M25x2; M25x2.5	-	1 1/16-8UN; 1-9UN; 1-10UNS; 1-12UNF; 1-14UNS; 1-16UN; 1-18UN; 1 1/16-20UNEF	1-11; 1-12; 1-14; 1-16;	3/4-14
RTMC 3230-55L4	30	-	M32x1; M32x1.5 M33x2; M33x2.5; M34x3	-	1 3/8-8UN; 1 3/8-9UN; 1 3/8-10UN; 1 1/16-12UN; 1 3/8-14UNS; 1 1/16-16UN; 1 1/16-18UNEF; 1 1/16-20UN	1 3/8-11; 1 3/8-12; 1 3/8-14; 1 3/8-16	1-11
BRTMC 3230-80L3	30	-	M32x1; M32x1.5 M33x2; M33x2.5; M34x3	-	1 3/8-8UN; 1 3/8-9UN; 1 3/8-10UN; 1 1/16-12UN; 1 3/8-14UNS; 1 1/16-16UN; 1 1/16-18UNEF; 1 1/16-20UN	1 3/8-11; 1 3/8-12; 1 3/8-14; 1 3/8-16	1-11

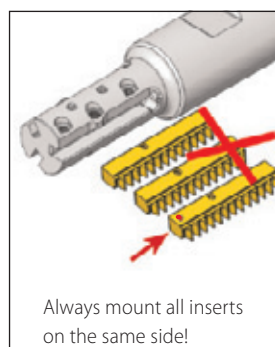
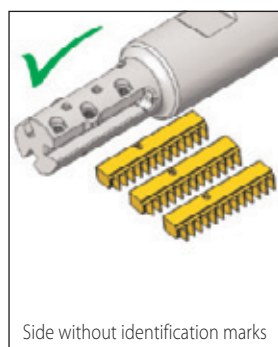
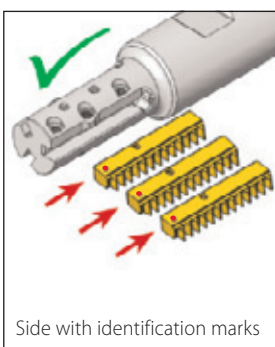

### 2 Step Clamping System!

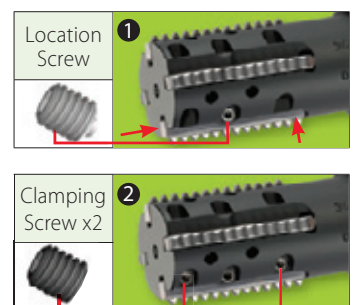

# Shell Mill (MiTM 40)

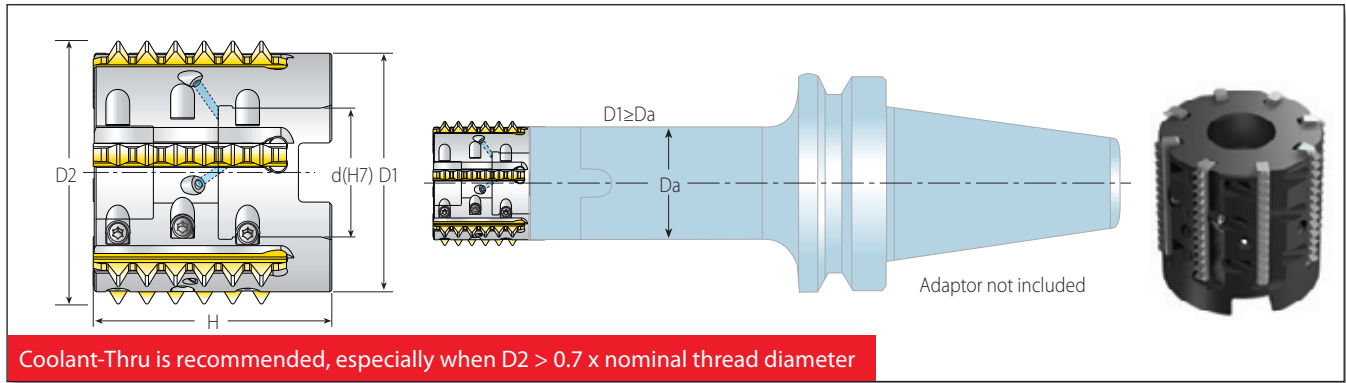

## Conical and Standard Shell Mills

Insert Style	Ordering Code	Dimensions (mm)					No. of Flutes	Spare Parts			
		mm	D1	D2	d(H7)	H		Z	Location Screw	Clamping Screw x2	Torx+ Screwdriver
Standard	RTMC D44-22-40L6	40	44	22	48	6	SLD4IP8A (M4x0.7)	SCD4IP8 (M4x0.7)	Torx+ Screwdriver	M10x1.5x40	
	RTMC D52-27-40L8	48	52	27	50	8				M12x1.75x40	
Conical	RTMNC D45-22-40L6	40	45	22	48	6			•Use the included Vardex Torx+ screwdriver only •Recommended max. torque 1.2 Nm	M10x1.5x40	

## Standard Thread Application per Toolholder

Toolholder		Min. Thread Ø				
D2 (mm)		ISO (fine)	UN/UNF/UNEF/UNS	BSW	BSP(G)	
Standard	RTMC D44-22-40L6	M48x1; M48x1.5; M48x2; M48x3	1 7/8-12UN; 1 13/16-16UN; 1 15/16-20UN; 1 5/8-8UN; 1 7/8-10UNS; 1 7/8-14UNS	2-16 2-12	1 1/2-11	
	RTMC D52-27-40L8	M55x1; M55x1.5; M55x2; M56x3	2 1/4-8UN; 2 1/4-10UN; 2 1/4-12UN; 2 1/4-14UN; 2 1/4-16UN; 2 1/4-18UN; 2 1/4-20UN	2 1/4-16 2 1/4-12	2-11	

## Conical Thread Application by Toolholder

Toolholder		Min. Thread Ø			
D2 (mm)		NPT	NPTF	BSPT	
Conical	RTMNC D45-22-40L6	2-11.5; 2 1/2-8 (and up)	2-11.5; 2 1/2-8; 3-8	2-6x11	

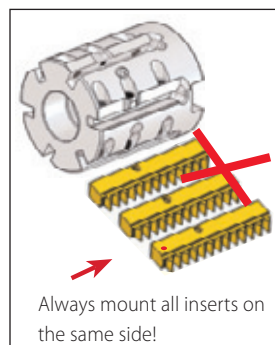
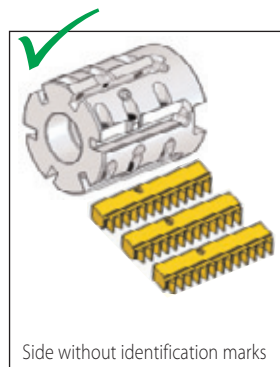
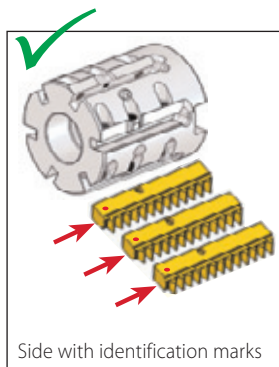

### 2 Step Clamping System!

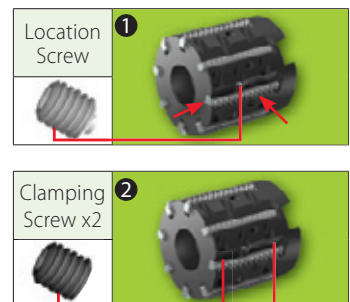

# Standard Toolholders (MiTM 41)

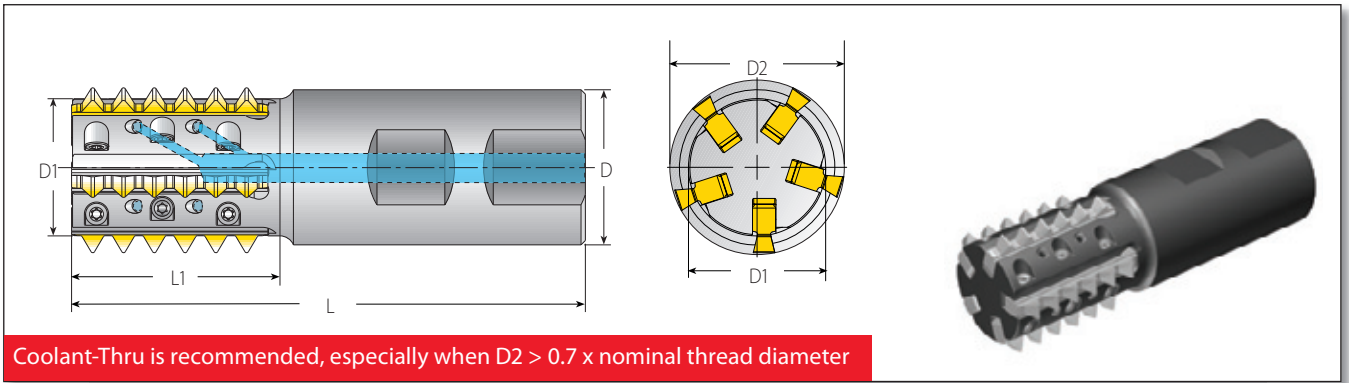

Coolant-Thru is recommended, especially when  $D2 > 0.7 \times$  nominal thread diameter

## RTMC - for Standard Threads

Insert Style	Ordering Code	Dimensions (mm)						No. of Flutes	Spare Parts		
		L	L1	D	D1	D2*	Z		Location Screw x2	Clamping Screw	Torx+ Screwdriver
mm		L	L1	D	D1	D2*	Z	Location Screw x2	Clamping Screw	Torx+ Screwdriver	
41	RTMC 2524-43B2	104	43	25	19.2	24.5	2	SLD4IP8A (M4x0.7)	SCD4IP8 (M4x0.7)	<b>KIP8</b> • Use the included Vardex Torx+ screwdriver only • Recommended max. torque 1.2 NxM	
	RTMC 3230-43B3	106.5	43	32	24.2	30	3				
	RTMC 3230-65B3	128.5	65	32	24.2	30	3				
	RTMC 3236-43B5	106	43	32	28.3	36	5				
	RTMC 3236-65B4	128	65	32	28.3	36	4				

## Standard Thread Application by Toolholder

Toolholder	Min. Thread Ø							
	D2* (mm)	ISO (coarse)	ISO (fine)	UNC	UN/UNF/UNEF/UNS	BSW/BSF	NPT	NPTF
RTMC 2524-43B2	24.5	M30x3.5; M36x4	M28X3; M45x4	1 1/8-7; 1 1/8-6	1 1/8-8UN; 1 1/16-6UN	1 3/8-8BSF; 1 1/4-7BSW	-	-
RTMC 3230-43B3	30	M36x4; M42x4.5	M34X3; M34x3.5; M45x4	1 3/8-6	1 3/8-8UN; 1 1/16-6UN	1 3/8-8BSF; 1 3/4-7BSF; 1 1/2-6BSW	-	-
RTMC 3230-65B3	30	M36x4; M42x4.5	M34X3; M34x3.5; M45x4	1 3/8-6	1 3/8-8UN; 1 1/16-6UN	1 3/8-8BSF; 1 3/4-7BSF; 1 1/2-6BSW	-	-
RTMC 3236-43B5	36	M42x4.5; M48x5; M56x5.5; M64x6	M40x3; M40x3.5; M42x4; M70x6	1 3/4-5; 2-4.5; 2 1/2-4	1 3/8-8UN; 1 1/8-6UN	1 5/8-8BSF; 1 3/4-7BSF; 1 1/8-6BSF	2 1/2-8	2 1/2-8
RTMC 3236-65B4	36	M42x4.5; M48x5; M56x5.5; M64x6	M40x3; M40x3.5; M42x4; M70x6	1 3/4-5; 2-4.5; 2 1/2-4	1 3/8-8UN; 1 1/8-6UN	1 5/8-8BSF; 1 3/4-7BSF; 1 1/8-6BSF	2 1/2-8	2 1/2-8

\* For external applications, inserts R41E... use for CNC program (D2+0.6mm)

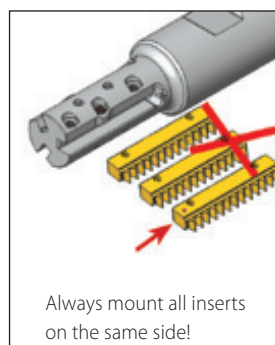
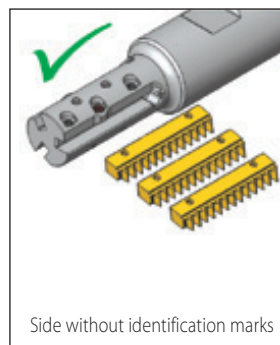
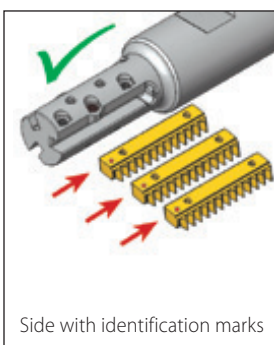

### 2 Step Clamping System!

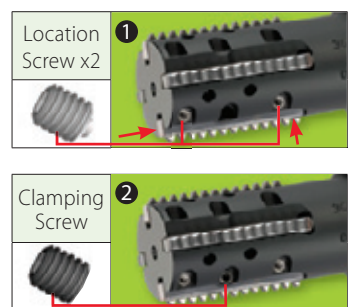

# Shell Mill (MiTM 41)

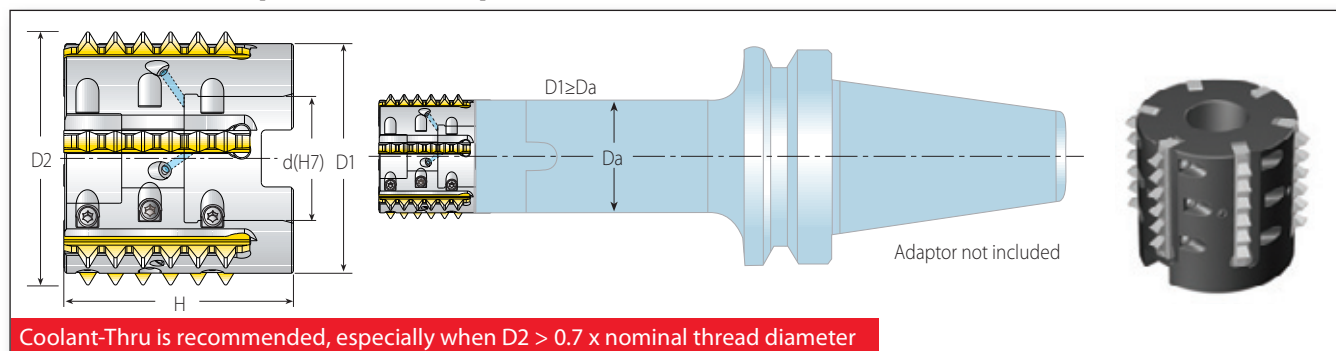

Standard Shell Mill					Spare Parts					
Insert Style	Ordering Code	Dimensions (mm)			No. of Flutes					
mm		D1	D2*	d(H7)	H	Z	Location Screw x2	Clamping Screw	Torx+ Screwdriver	
41	RTMC D48-22-41B5	40	48	22	50	5	SLD4IP8A (M4x0.7)	SCD4IP8 (M4x0.7)	<b>KIP8</b> •Use the included Vardex Torx+ screwdriver only •Recommended max. torque 1.2 NxM	M10x1.5x40
	RTMC D58-27-41B6	50	58	27	50	6				M12x1.75x40

## Standard Thread Application by Toolholder

Toolholder	Min. Thread Ø							
	D2* (mm)	ISO (coarse)	ISO (fine)	UNC	UN/UNF/UNEF/UNS	BSF	NPT	NPTF
RTMC D48-22-41B5	48	M56x5.5; M64x6	M55x4; M70x6;	2¼-4.5; 2½-4	2½-8UN; 2½-6UN	2¼-8; 2¼-6	2½-8	2½-8
RTMC D58-27-41B6	58	M68x6	M64x4; M70x6	2¾-4	2½-8UN; 2½-6UN	2½-8; 2¾-6	2½-8	2½-8

\* For external applications, inserts R41E... use for CNC program (D2+0.6mm)

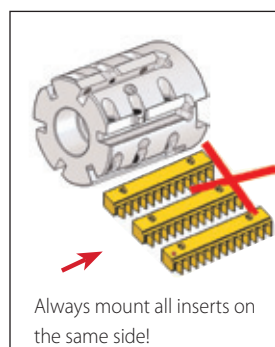
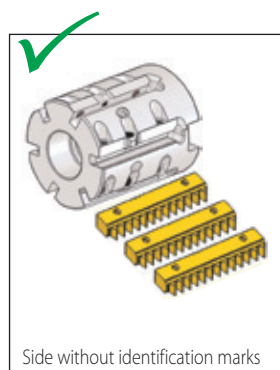
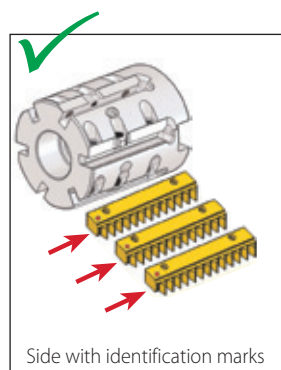

### 2 Step Clamping System!

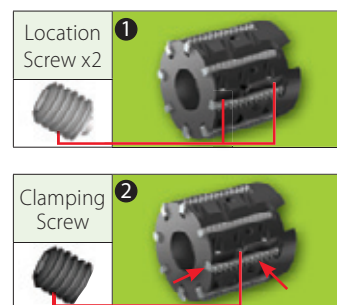





## Recommended Grades, Cutting Speeds Vc [m/min] and Feed f [mm/tooth]

Material Group	Vardex No.	Material	Hardness Brinell HB	Vc [mm/min]		Feed f [mm/tooth]	
				VBX	VTX	f	
<b>P</b> Steel	1	Unalloyed steel	Low carbon (C=0.1-0.25%)	125	100-210	90-180	0.1-0.35
	2		Medium carbon (C=0.25-0.55%)	150	100-180	90-170	0.1-0.4
	3		High Carbon (C=0.55-0.85%)	170	100-170	90-160	0.1-0.35
	4	Low alloy steel (alloying elements ≤5%)	Non hardened	180	90-60	90-155	0.1-0.4
	5		Hardened	275	80-150	80-160	0.1-0.35
	6		Hardened	350	70-140	70-150	0.1-0.3
	7	High alloy steel (alloying elements >5%)	Annealed	200	60-130	70-115	0.1-0.35
	8		Hardened	325	70-110	60-100	0.1-0.2
	9	Cast steel	Low alloy (alloying elements <5%)	200	100-170	100-170	0.1-0.3
	10		High alloy (alloying elements >5%)	225	70-120	70-130	0.1-0.2
<b>M</b> Stainless Steel	11	Stainless steel Ferritic	Non hardened	200	100-170	120-180	0.1-0.3
	12		Hardened	330	100-170	120-180	0.1-0.2
	13	Stainless steel Austenitic	Austenitic	180	70-140	100-140	0.1-0.3
	14		Super Austenitic	200	70-140	100-140	0.1-0.2
	15	Stainless steel Cast Ferritic	Non hardened	200	70-140	100-140	0.1-0.3
	16		Hardened	330	70-140	100-140	0.1-0.2
	17	Stainless steel Cast austenitic	Austenitic	200	70-120	100-120	0.1-0.3
	18		Hardened	330	70-120	100-120	0.1-0.2
<b>K</b> Cast Iron	28	Malleable Cast iron	Ferritic (short chips)	130	60-130	100-120	0.05-0.16
	29		Pearlitic (long chips)	230	60-120	80-100	0.04-0.10
	30	Grey cast iron	Low tensile strength	180	60-130	80-100	0.1-0.3
	31		High tensile strength	260	60-100	80-100	0.1-0.2
	32	Nodular SG iron	Ferritic	160	60-125	80-100	0.1-0.3
	33		Pearlitic	260	50-90	60-90	0.1-0.2
<b>N(K)</b> Non-Ferrous Metals	34	Aluminium alloys Wrought	Non aging	60	100-250		0.15-0.55
	35		Aged	100	100-180		0.15-0.5
	36	Aluminium alloys	Cast	75	150-400		0.15-0.5
	37		Cast & aged	90	150-280		0.1-0.4
	38	Aluminium alloys	Cast Si 13-22%	130	80-150		0.15-0.5
	39	Copper and copper alloys	Brass	90	120-210	100-200	0.15-0.5
40	Bronze and non leaded copper		100	120-210	100-200	0.1-0.4	
<b>S(M)</b> Heat Resistant Material	19	High temperature alloys	Annealed (Iron based)	200	20-45	20-40	0.1-0.2
	20		Aged (Iron based)	280	20-30	20-30	0.04-0.10
	21		Annealed (Nickel or Cobalt based)	250	15-20	15-20	0.04-0.10
	22		Aged (Nickel or Cobalt based)	350	10-15	10-15	0.04-0.10
	23	Titanium alloys	Pure 99.5 Ti	400Rm	70-140	70-120	0.04-0.10
	24		α+β alloys	1050Rm	20-50	20-50	0.04-0.10
<b>H(K)</b> Hardened Material	25	Extra hard steel	Hardened & tempered	45-50HRc	15-45	15-45	0.06-0.12
	26			51-55HRc	15-40	15-40	0.04-0.08

### Grades

Grade	Application	Sample
<b>VBX</b>	TiCN coated carbide grade. Excellent grade for steels and general use.	
<b>VTX</b>	TiAlN coated carbide grade. Ideal for Stainless Steels.	



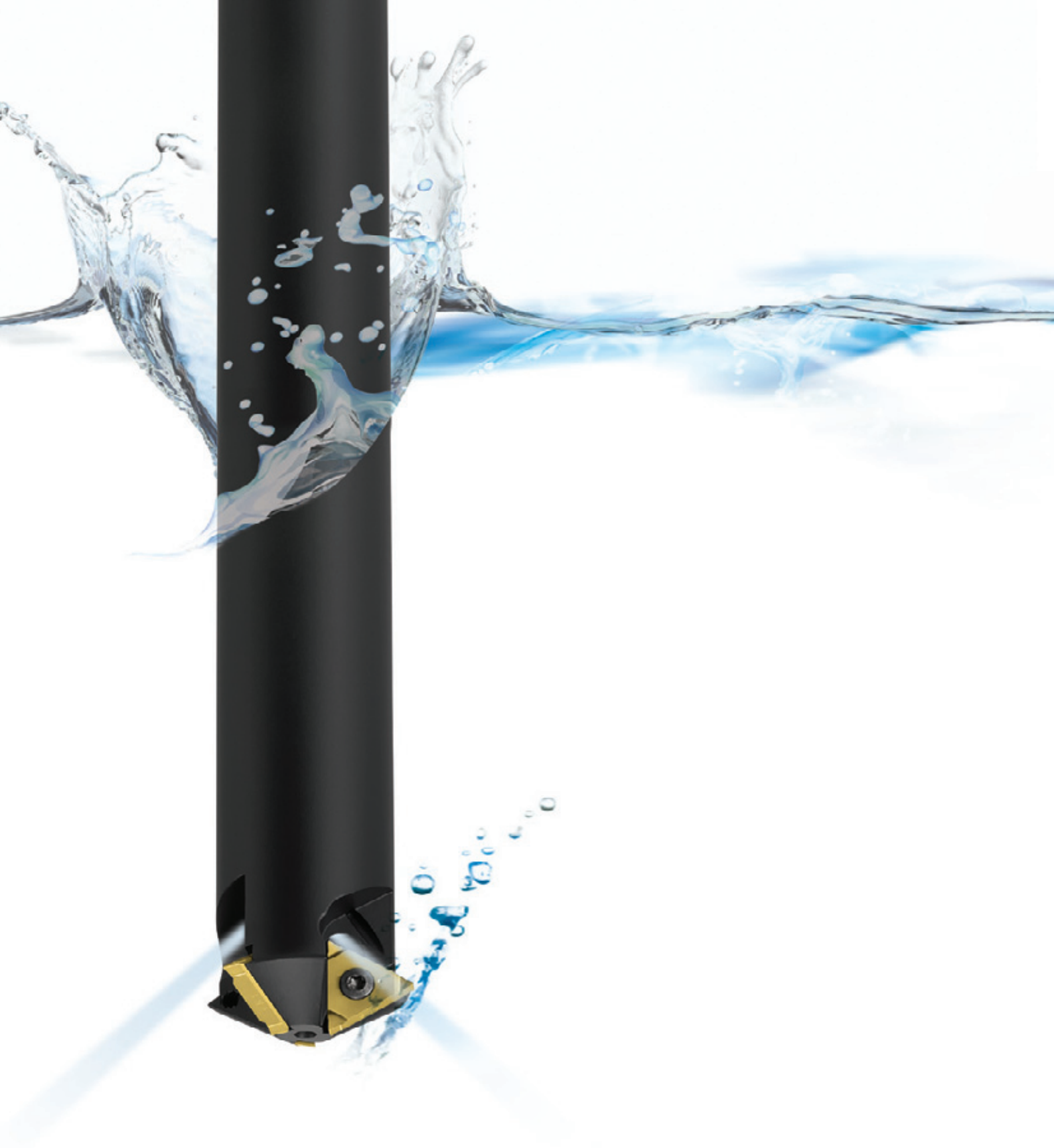

# TMSD

Thread Mill for Deep Holes

- > Inserts
- > Toolholders
- > Technical Data



# TMSD - THREAD MILL FOR DEEP HOLES

■ VARDEX Ordering Code System.....	Page 276
------------------------------------	----------

## Inserts

■ Partial Profile 60°.....	Page 277
■ Partial Profile 55°.....	Page 278
■ Trapez.....	Page 279

## Toolholders

■ Weldon Shank (Mini L-Style).....	Page 280
■ Carbide Cylindrical Shank (Mini L-Style).....	Page 281
■ Weldon Shank (U-Style).....	Page 282
■ Carbide Cylindrical Shank (U-Style).....	Page 283
■ Steel Cylindrical Shank (U-Style).....	Page 284
■ Shell Mill (U-Style).....	Page 285
■ Steel Cylindrical Shank (A-Style).....	Page 286

## Technical Data

■ Recommended Cutting Speeds and Feed.....	Page 287
--	----------



TM Gen Software and updated versions can be downloaded from [www.vargus.com](http://www.vargus.com)

A multi-flute, high-productivity, and economical solution for milling threads in deep holes

### Smooth Cut

- Reduced load on the cutting edges due to single point insert design

### Wide Range of Pitches

- Partial profile

### Cost Effective

- Up to 3 cutting edges per insert
- Very high feed per tooth

### Fast Machining

- Multi-flute, up to 7 cutting edges (inserts)

### Long Overhang

- Up to 144mm (200mm in Shell Mill)

### Tool Cutting Diameter

- As small as 13mm

### Cooling Thru

- For improved chip evacuation and cooling the cutting corner

# TMSD

## Thread Mill for Deep Holes

A multi-flute, high-productivity, and economical solution for milling threads in deep holes

### Mini L For Small Bores and Short L2



Tool Overhang (L1) 29-42  
Cutting Dia. (D2) 13-17.7  
No. of Flutes (Z) 1-3



Tool Overhang (L1) 20-65  
Cutting Dia. (D2) 13-17.7  
No. of Flutes (Z) 1-3

### U Style For Large Pitches



Tool Overhang (L1) 40-120  
Cutting Dia. (D2) 14.75-42  
No. of Flutes (Z) 1-4



Tool Overhang (L1) 25-65  
Cutting Dia. (D2) 14.75-20.65  
No. of Flutes (Z) 1-2



Tool Overhang (L1) 40-144  
Cutting Dia. (D2) 23.3-36.5  
No. of Flutes (Z) 2-4



Tool Overhang (L1) Max. 200  
Cutting Dia. (D2) 42-98  
No. of Flutes (Z) 4-7

### A Style For Shorter L2







Tool Overhang (L1) 50-144  
Cutting Dia. (D2) 26-35.3  
No. of Flutes (Z) 3

# Vardex Ordering Code System

## TMSD Inserts

<b>2</b>	<b>U</b>	<b>I</b>	<b>DB</b>	<b>60</b>	<b>TM</b>	<b>VBX</b>
<b>1</b>	<b>2</b>	<b>3</b>	<b>4</b>	<b>5</b>	<b>6</b>	<b>7</b>

<b>1 - Insert Size</b> 5L - IC5.0L mm 2 - IC1/4" 3 - IC3/8" 4 - IC1/2" 	<b>2 - Insert Style</b> U -  A -  L - 	<b>3 - Type of Insert</b> I - Internal	<b>4 - Pitch</b> Full Profile - Pitch Range <table border="1"> <tr> <td>mm</td> <td>tpi</td> </tr> <tr> <td>2.0-5.0</td> <td>-</td> </tr> </table> Partial Profile - Pitch Range <table border="1"> <tr> <td></td> <td>mm</td> <td>tpi</td> </tr> <tr> <td>DA</td> <td>0.5-1.5</td> <td>48-16</td> </tr> <tr> <td>DB</td> <td>1.5-2.0</td> <td>16-12</td> </tr> <tr> <td>DC</td> <td>2.5-4.0</td> <td>10-6</td> </tr> <tr> <td>DD</td> <td>2.0-2.5</td> <td>9-12</td> </tr> <tr> <td>DE</td> <td>2.5-3.5</td> <td>10-7</td> </tr> <tr> <td>DH</td> <td>4.0-6.0</td> <td>6-4</td> </tr> <tr> <td>DK</td> <td>6.0-8.0</td> <td>4-3</td> </tr> <tr> <td>DL</td> <td>-</td> <td>11-7</td> </tr> <tr> <td>DM</td> <td>2.5</td> <td>10</td> </tr> <tr> <td>DN</td> <td>1.0-2.0</td> <td>24-11</td> </tr> <tr> <td>DP</td> <td>1.5-3.0</td> <td>16-8</td> </tr> <tr> <td>DR</td> <td>-</td> <td>26-14</td> </tr> <tr> <td>DT</td> <td>2.0-4.0</td> <td>12-6</td> </tr> </table>	mm	tpi	2.0-5.0	-		mm	tpi	DA	0.5-1.5	48-16	DB	1.5-2.0	16-12	DC	2.5-4.0	10-6	DD	2.0-2.5	9-12	DE	2.5-3.5	10-7	DH	4.0-6.0	6-4	DK	6.0-8.0	4-3	DL	-	11-7	DM	2.5	10	DN	1.0-2.0	24-11	DP	1.5-3.0	16-8	DR	-	26-14	DT	2.0-4.0	12-6	<b>5 - Standard</b> 60° - Partial Profile 60° 55° - Partial Profile 55° TR - Trapez DIN 103	<b>6 - System</b> TM	<b>7 - Carbide Grade</b> VBX, VTX
mm	tpi																																																			
2.0-5.0	-																																																			
	mm	tpi																																																		
DA	0.5-1.5	48-16																																																		
DB	1.5-2.0	16-12																																																		
DC	2.5-4.0	10-6																																																		
DD	2.0-2.5	9-12																																																		
DE	2.5-3.5	10-7																																																		
DH	4.0-6.0	6-4																																																		
DK	6.0-8.0	4-3																																																		
DL	-	11-7																																																		
DM	2.5	10																																																		
DN	1.0-2.0	24-11																																																		
DP	1.5-3.0	16-8																																																		
DR	-	26-14																																																		
DT	2.0-4.0	12-6																																																		

## TMSD Toolholders

<b>C</b>	<b>TM</b>	<b>2</b>	<b>S</b>	<b>C</b>	<b>14</b>	<b>C</b>	<b>17</b>	<b>-</b>	<b>65</b>	<b>-</b>	<b>2</b>	<b>U</b>
<b>1</b>	<b>2</b>	<b>3</b>	<b>4</b>	<b>5</b>	<b>6</b>	<b>7</b>	<b>8</b>		<b>9</b>		<b>10</b>	<b>11</b>

<b>1 - Shank Style</b> None - Steel C - Carbide Shank	<b>2 - System</b> TM	<b>3 - No. of Flutes</b> 1 - 4	<b>4 - Insert Type</b> S - Single Point	<b>5 - Cooling</b> C - Coolant	<b>6 - Shank Dia.</b> 9.5 - 40	<b>7 - Shank Type</b> W - Weldon C - Cylindrical	<b>8 - Cutting Dia.</b> 13 - 42
---	-------------------------	-----------------------------------	--	-----------------------------------	-----------------------------------	--	------------------------------------

<b>9 - Max. Tool Overhang</b> 29 - 144	<b>10 - Insert Size</b> 5L - IC5.0L mm 2 - IC1/4" 3 - IC3/8" 4 - IC1/2"	<b>11 - Insert Style</b> U A L
---	---	---

## TMSD Shell Mill

<b>TM</b>	<b>4</b>	<b>S</b>	<b>C</b>		<b>D42</b>	<b>-</b>	<b>16</b>	<b>-</b>	<b>3</b>	<b>U</b>
<b>1</b>	<b>2</b>	<b>3</b>	<b>4</b>		<b>5</b>		<b>6</b>		<b>7</b>	<b>8</b>

<b>1 - System</b> TM	<b>2 - No. of Flutes</b> 4-7	<b>3 - Insert Type</b> S - Single Point	<b>4 - Cooling</b> C - Coolant	<b>5 - Cutting Dia.</b> 42 - 98	<b>6 - Drive Hole Dia.</b> 16, 22, 27, 32	<b>7 - Insert Size</b> 3 - IC3/8" 4 - IC1/2"
-------------------------	---------------------------------	--	-----------------------------------	------------------------------------	--	--

<b>8 - Insert Style</b> U
------------------------------

# TMSD - Partial Profile 60°

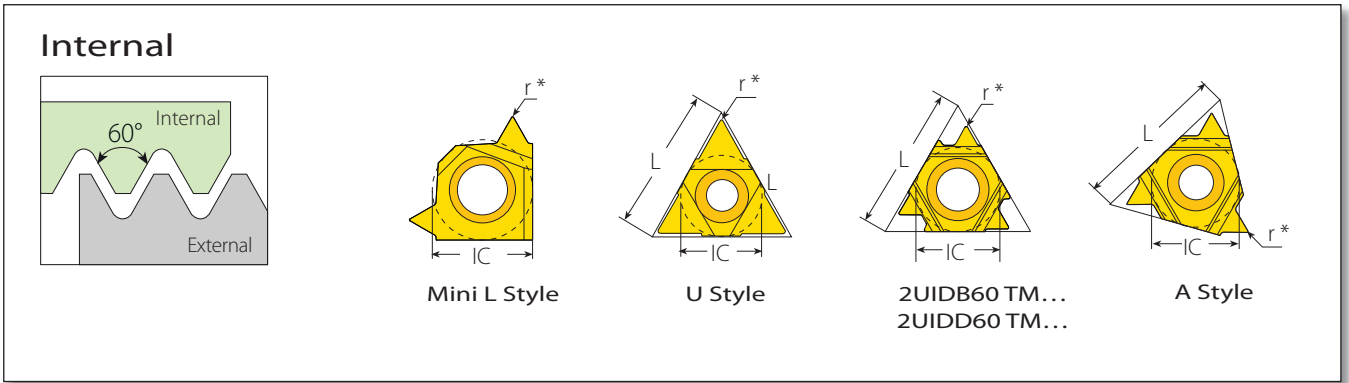

## Mini-L



Insert Size		Pitch		Ordering Code	Dimensions (mm)	
IC	L mm	mm	tpi	Internal	r*	Toolholder
5.0L	-	0.5-1.5	48-16	5LIDA60 TM...	0.04	TM.SC...5L
		1.0-2.0	24-11	5LIDN60 TM...	0.06	CTM. SC...5L

## U Style



Insert Size		Pitch		Ordering Code	Dimensions (mm)	
IC	L mm	mm	tpi	Internal	r*	Toolholder
1/4"U	11	0.5-1.5	48-16	2UIDA60 TM...	0.05	TM.SC...2U
		1.5-2.0	16-12	2UIDB60 TM...	0.06	CTM. SC...2U
		2.0-2.5	9-12	2UIDD60 TM...	0.11	CTM2SC 14C17-65-2U
		2.5	10	2UIDM60 TM...	0.11	
3/8"U	16	2.5-4.0	10-6	2UIDC60 TM...	0.14	TM.SC...2U CTM. SC...2U
		1.5-2.0	16-12	3UIDB60 TM...	0.06	TM.SC...3U
		2.5-3.5	10-7	3UIDE60 TM...	0.14	
1/2"U	22	4.0-6.0	6-4	3UIDH60 TM...	0.25	TM.SC D...4U
6.0-8.0	4-3	4UIDK60 TM...	0.30			

## A Style



Insert Size		Pitch		Ordering Code	Dimensions (mm)	
IC	L mm	mm	tpi	Internal	r*	Toolholder
1/4"A	11	1.5-3.0	16-8	2AIDP60 TM...	0.06	TM.SC...2A
3/8"A	16	2.0-4.0	12-6	3AIDT60 TM...	0.08	TM.SC...3A

\* The indicated radius (r) refers to the insert nose radius only

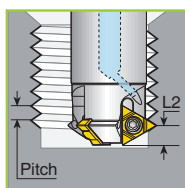

U Style  
For Large Pitches

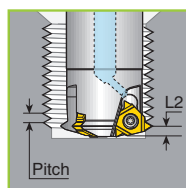

A Style  
For Shorter L2

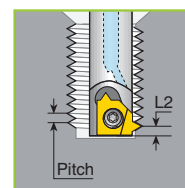

Mini-L Style  
For Small Bores and Short L2

# TMSD - Partial Profile 55°

## Internal

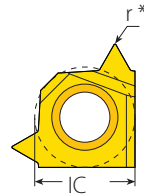
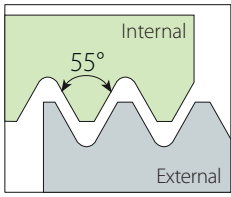

Mini L Style

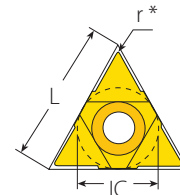

U Style

## Mini-L



Insert Size	Pitch	Ordering Code	Dimensions (mm)	Toolholder
IC	tpi	Internal	r*	
5.0L	26-14	5LIDR55 TM...	0.10	TM.SC...5L CTM. SC...5L

## U Style



Insert Size	Pitch	Ordering Code	Dimensions (mm)	Toolholder	
IC	L mm	tpi	Internal	r*	
1/4"U	11	48-16	2UIDA55 TM...	0.11	TM.SC...2U CTM. SC...2U
		16-12	2UIDB55 TM...	0.08	
		11-7	2UIDL55 TM...	0.24	
3/8"U	16	16-12	3UIDB55 TM...	0.08	TM.SC...3U
		11-7	3UIDL55 TM...	0.24	
1/2"U	22	4-3	4UIDK55 TM...	0.50	TM.SC...4U

\* The indicated radius (r) refers to the insert nose radius only

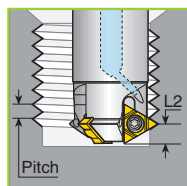

U Style  
For Large Pitches

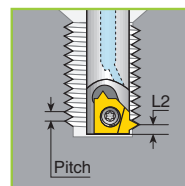

Mini-L Style  
For Small Bores and Short L2



# TMSD - Trapez

## Internal

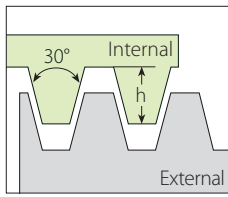

Defined by: DIN 103  
Tolerance class: 7e/7H

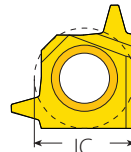

Mini L Style

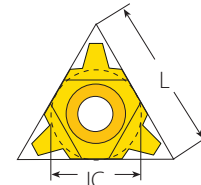

U Style

## Mini-L



Insert Size	Pitch	Ordering Code	Application	Toolholder
IC	mm	Internal	Internal	
5.0L	2.0	5LI2.0TR-1 TM...	TR16x2, TR20x2	See pages 8-9
		5LI2.0TR-2 TM...	TR18x2	

## U Style



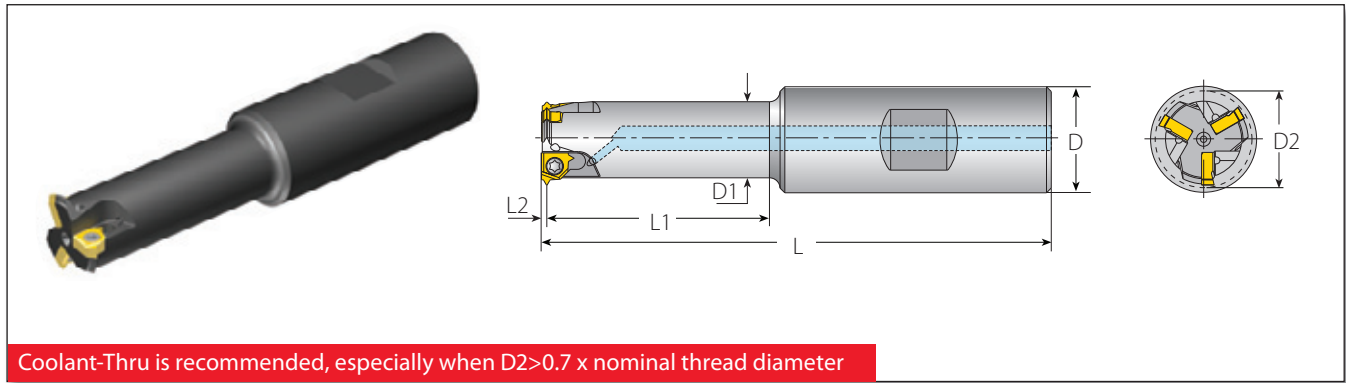

Insert Size	Pitch	Ordering Code	Application	Toolholder	
IC	L mm	mm	Internal	Internal	
1/4"U	11	3.0	2UI3TR-1 TM...	(TR22-TR30)x3	See pages 10-11
			2UI3TR-2 TM...	(TR32-TR60)x3	
		4.0	2UI4TR-1 TM...	(TR20-TR28)x4	
			2UI4TR-2 TM...	(TR65-TR110)x4	
		5.0	2UI5TR-1 TM...	TR22x5; TR28x5	
			2UI5TR-2 TM...	TR24x5; TR26x5	

## TMSD Standard Toolholder - Weldon Shank (Mini L-Style)



### Weldon Shank for Mini-L Style Inserts

### Spare Parts

Insert Size	Ordering Code	Dimensions (mm)						No. of Flutes	Spare Parts	
		L	L1	L2	D	D1	D2		Insert Screw	Torx Key
IC										
5.0L	TM1SC 16W13-29-5L	81	29		16	9.8	13	1	SN5LTR	K7T
	TM2SC 16W14-33-5L	85	33	1.1	16	10.3	13.5	2		
	TM3SC 20W18-42-5L	96	42		20	14.3	17.7	3		

### Thread Applications for Mini-L Style Toolholders (Weldon Shank)

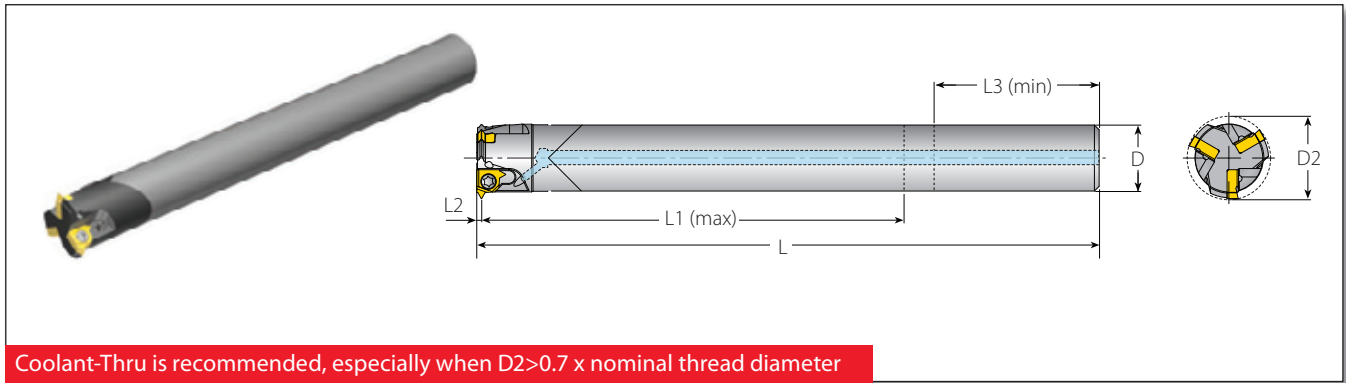

Toolholder	Min. Thread Ø						
	D2	ISO Coarse	ISO Fine	UN/UNF/UNEF/UNS	BSP (G)	Partial 55°	Trapez
TM1SC 16W13-29-5L	13	M16x2	M14x0.5; M14x0.75; M14.5x1.0; M15x1.5; M17x2.0	1/16-32UN; 1/16-28UN; 1/16-27UNS; 1/16-24UNEF; 5/8-20UN; 5/8-18UNF; 5/8-16UN; 5/8-14UNS; 5/8-12UN	3/8-19	5/8-14	TR16X2; TR18X2
TM2SC 16W14-33-5L	13.5	M16x2	M15x0.5; M15x0.75; M15x1.0; M16x1.5; M17x2.0	5/8-32UN; 5/8-28UN; 5/8-27UNS; 1/16-24UNEF; 5/8-20UN; 5/8-18UNF; 5/8-16UN; 5/8-14UNS; 11/16-12UN	3/8-19	11/16-14	TR16X2; TR18X2
TM3SC 20W18-42-5L	17.7	-	M19x0.5; M19x0.75; M19x1.0; M20x1.5; M20x2.0	3/4-32UN; 3/4-28UN; 7/8-27UNS; 3/4-24UNS; 13/16-20UNEF; 7/8-18UNS; 13/16-16UN; 7/8-14UNF; 13/16-12UN	1/2-14	-	TR20X2

## TMSD Standard Toolholder - Carbide Cylindrical Shank (Mini L-Style)



### Carbide Cylindrical Shank for Mini-L Style Inserts

#### Spare Parts

Insert Size	Ordering Code	Dimensions (mm)							No. of Flutes	Spare Parts	
		L	L1 (max)	L2	L3 (min)	D	D2	Z		 Insert Screw	 Torx Key
5.0L	CTM1SC 09C13-43-5L	109	43		20	9.5	13	1	SN5LTR	K7T	
	CTM2SC 10C14-50-5L	116	50	1.1	22	10	13.5	2			
	CTM3SC 14C18-65-5L	132	65		30	14	17.7	3			

### Thread Applications for Mini-L Style Toolholders (Carbide Cylindrical Shank)

Toolholder	Min. Thread Ø						
	D2	ISO Coarse	ISO Fine	UN/UNF/UNEF/UNS	BSP (G)	Partial 55°	Trapez
CTM1SC 09C13-43-5L	13	M16x2	M14x0.5; M14x0.75; M14.5x1.0; M15x1.5; M17x2.0	3/16-32UN; 3/16-28UN; 3/16-27UNS; 3/16-24UNEF; 5/8-20UN; 5/8-18UNF; 5/8-16UN; 5/8-14UNS; 5/8-12UN	3/8-19	5/8-14	TR16X2; TR18X2
CTM2SC 10C14-50-5L	13.5	M16x2	M15x0.5; M15x0.75; M15x1.0; M16x1.5; M17x2.0	3/8-32UN; 3/8-28UN; 3/8-27UNS; 3/8-24UNEF; 5/8-20UN; 5/8-18UNF; 5/8-16UN; 5/8-14UNS; 11/16-12UN	3/8-19	11/16-14	TR16X2; TR18X2
CTM3SC 14C18-65-5L	17.7	-	M19x0.5; M19x0.75; M19x1.0; M20x1.5; M20x2.0	3/4-32UN; 3/4-28UN; 7/8-27UNS; 3/4-24UNS; 13/16-20UNEF; 7/8-18UNS; 13/16-16UN; 7/8-14UNF; 13/16-12UN	1/2-14	-	TR20X2

# TMSD Standard Toolholder - Weldon Shank (U-Style)

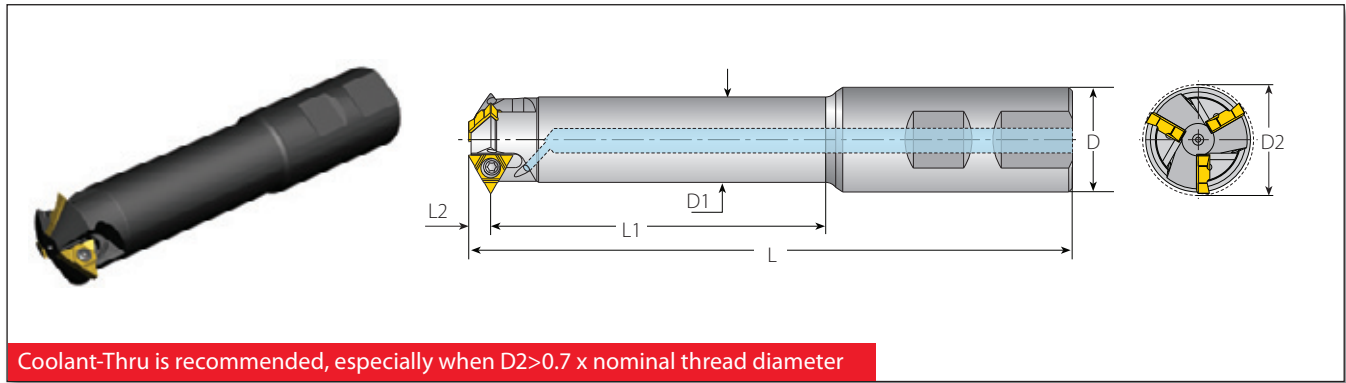

## Weldon Shank for U-Style Inserts

Insert Size	Ordering Code	Dimensions (mm)							No. of Flutes	Spare Parts	
		L	L1	L2	D	D1	D2	Z		Insert Screw	Torx Key
1/4"U	TM1SC 16W15-40-2U	95	40	5.4	16	11	14.75*	1	SN2T	HK2T	
	TM2SC 25W21-60-2U	123	60		25	16	20.65*	2			
	TM2SC 25W23-70-2U	135	70		25	17.7	23	2			
	TM3SC 25W26-80-2U	147	80		25	20.4	26	3			
	TM4SC 32W31-95-2U	164	95		32	25.7	31	4			
3/8"U	TM3SC 32W36-95-3U	166	95	8.0	32	29	36.5	3	SA3T	HK3T	
	TM4SC 40W42-120-3U	201	120		40	34.2	42	4	SN3T		

## Thread Application for U-Style Toolholders (Weldon Shank)



Toolholder	Min. Thread Ø							
	D2	ISO Coarse	ISO Fine	UNC	UN/UNF/UNEF/UNS	BSP (G)	Partial 55°	Trapez
TM1SC 16W15-40-2U	14.75*	M18x2.5, M24x3.0	M16x0.5, M16x0.75, M16x1.0, M17x1.25, M17x1.5, M17x2.0	¾-10	⅝-32UN, ⅝-28UN, ⅝-27UNS, 11/16-24UN, 11/16-20UN, 11/16-16UN, ¾-14UNS, ¾-12UN	¾-19, ½-14, 1-11	11/16-14; ¾-12; 7/8-11; ¾-10; 7/8-9; 1-8; 1 1/8-7	TR22x3, TR24x3
TM2SC 25W21-60-2U	20.65*	M24x3.0, M30x3.5	M22x0.5, M22x0.75, M22x1.0, M23x1.25, M23x1.5, M23x2.0	1-8 UNC, 1 1/8 7UNC, 1 3/8 6UNC	7/8-32UN, 7/8-28UN, 7/8-27UNS, 7/8-24UNS, 7/8-20UNEF, 1-18UNS, 1 1/8-16UN, 1-14UNS, 1 1/8-12UN, 1-10UNS	¾-14, 1-11	1-26, 1-20, 1-16, 1-12, 1-10, 1 1/8-9, 1-8, 1 1/8-7	(TR26-TR60x3)
TM2SC 25W23-70-2U	23	M27x3.0, M30x3.5, M36x4.0	M24x0.5, M24x0.75, M25x1.0, M25x1.25, M26x1.5, M26x2.0, M27x2.5	1 1/8-7	1-32UN, 1-28UN, 1-27UNS, 1-24UNS, 1-20UNEF, 1-18UNS, 1-16UN, 1-14UNS, 1-12UNF, 1 1/8-10UNS, 1 1/8-8UN	¾-14, 1-11	1-26, 1-20, 1-16, 1 1/8-12, 1 1/8-9, 1 1/8-7	-
TM3SC 25W26-80-2U	26	M30x3.5, M36x4.0	M27x0.5, M27x0.75, M28x1.0, M28x1.25, M28x1.5, M29x2.0, M30x2.5, M30x3.0	1 1/4-7, 1 3/8-6	1 1/8-28UN, 1 1/8-24UNS, 1 1/8-20UN, 1 1/8-18UNEF, 1 1/8-16UN, 1 1/8-14UNS, 1 1/8-12UNF, 1 1/4-10UNS, 1 3/8-8UN	7/8-14, 1-11	1 1/8-26, 1 1/8-20, 1 3/8-16, 1 3/8-12, 1 3/8-8, 1 1/4-7	-
TM4SC 32W31-95-2U	31	M36x4.0	M32x0.5, M32x0.75, M33x1.0, M33x1.25, M33x1.5, M34x2.0, M34x2.5, M35x3.0, M36x3.5	1 1/2-6	1 3/8-28UN, 1 3/8-24UNS, 1 3/8-20UN, 1 3/8-18UNEF, 1 3/8-16UN, 1 3/8-14UNS, 1 3/8-12UNF, 1 3/8-10UNS, 1 3/8-8UN	1 1/8-11	1 3/8-26, 1 3/8-20, 1 3/8-16, 1 3/8-12, 1 1/8-8	-
TM3SC 32W36-95-3U	36.5	M42x4.5, M48x5.0, M56x5.5, M64x6.0	M39x1.5, M39x2.0, M40x2.5, M41x3.0, M42x3.5, M42x4.0	1 3/4-5, 2-4.5, 2 1/2-4	1 1/8-16UN, 1 1/8-14UNS, 1 1/8-12UN, 1 1/8-10UNS, 1 1/8-8UN, 1 1/8-6UN	1 1/4-11	1 1/8-16, 1 1/8-12, 1 1/8-8, 2 1/4-6, 1 3/4-5	-
TM4SC 40W42-120-3U	42	M48x5.0, M56x5.5, M64x6.0	M45x1.5, M45x2.0, M46x2.5, M48x3.0, M48x3.5, M48x4.0	2-4.5, 2 1/2-4	1 3/4-16UN, 1 3/4-14UNS, 1 13/16-12UN, 1 13/16-8UN, 1 15/16-6UN	1 1/2-11	1 7/8-16, 1 7/8-12, 1 7/8-8, 1 7/8-6, 2-4.5	-

\* For TR inserts use for the CNC program (D2+0.25mm)

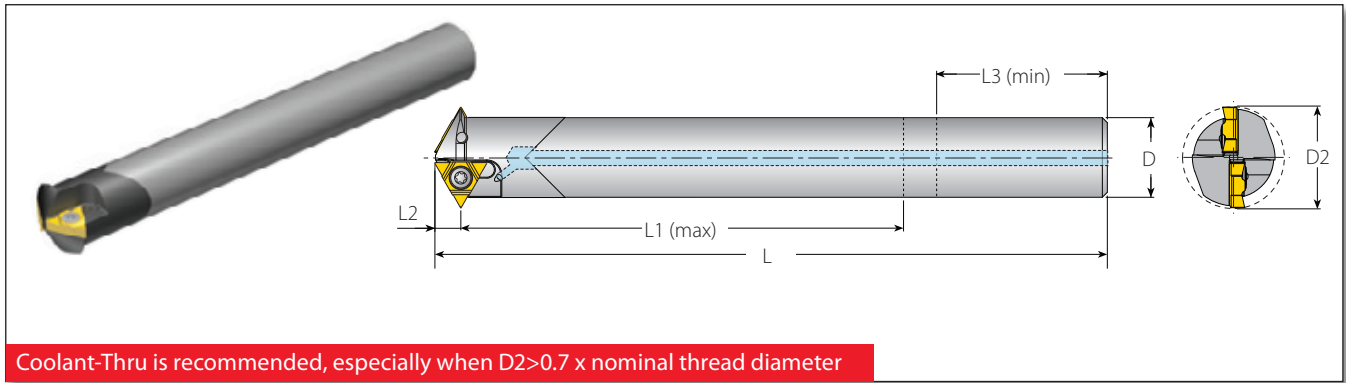
## TMSD Standard Toolholder - Carbide Cylindrical Shank (U-Style)



### Carbide Cylindrical Shank for U-Style Inserts

Carbide Cylindrical Shank for U-Style Inserts									Spare Parts	
Insert Size	Ordering Code	Dimensions (mm)						No. of Flutes		
IC		L	L1 (max)	L2	L3 (min)	D	D2	Z	Insert Screw	Torx Key
1/4"U	CTM1SC 08C15-40-2U	109	40	5.4	18	8	14.75*	1	SN2T	HK2T
	CTM1SC 11C15-60-2U	120	60	5.4	25	10.7	14.75*	1		
	CTM2SC 14C17-65-2U**	132	65	3.4	30	14	17.2**	2		
	CTM2SC 14C21-65-2U	136	65	5.4	30	14	20.65*	2		
	CTM2SC 16C21-80-2U	135	80	5.4	34	16	20.65*	2		

### Thread Applications for U-Style Toolholder (Carbide Cylindrical Shank)

Toolholder	Min. Thread Ø							
	D2	ISO Coarse	ISO Fine	UNC	UN/UNF/UNEF/UNS	BSP (G)	Partial 55°	Trapez
CTM1SC 08C15-40-2U	14.75*	M18x2.5, M24x3.0, M30x3.5, M36x4.0	M16x0.5, M16x0.75, M16x1.0, M17x1.25, M17x1.5, M17x2.0	¾-10, ⅞-9, 1-8, 1⅜-7, 1⅝-6	⅝-32UN, ⅞-28UN, ⅞-27UNS, 1⅜-24UNEF, 1⅜-20UN, 1⅜-16UN, ¾-14UNS, 1⅜-12UN	½-14, 1-11	1⅜-26, 1⅜-20, 1⅜-16, 1⅜-14, ¾-12, ⅞-11, ¾-10, ⅞-9, 1-8, 1⅜-7	TR22x3, TR24x3, TR20x4, TR22x5, TR24x5, TR26x5, TR28x5
CTM1SC 11C15-60-2U	14.75*	M18x2.5, M24x3.0	M16x0.5, M16x0.75, M16x1.0, M17x1.25, M17x1.5, M17x2.0	¾-10, ⅞-9, 1-8	⅝-32UN, ⅞-28UN, ⅞-27UNS, 1⅜-24UNEF, 1⅜-20UN, 1⅜-16UN, ¾-14UNS, 1⅜-12UN	½-14, 1-11	1⅜-26, 1⅜-20, 1⅜-16, 1⅜-14, ¾-12, ⅞-11, ¾-10, ⅞-9	TR22x3, TR24x3
CTM2SC 14C17-65-2U	17.2**	M20x2.5, M22x2.5	M21x2.0	⅞-9	⅞-10UNS, 1⅜-12UN	-	-	-
CTM2SC 14C21-65-2U	20.65*	M24x3.0, M30x3.5, M36x4.0	M22x0.5, M22x0.75, M22x1.0, M23x1.25, M23x1.5, M23x2.0	1-8, 1⅜-7, 1⅝-6	⅞-32UN, ⅞-28UN, ⅞-27UNS, ⅞-24UNS, ⅞-20UNEF, 1-18UNS, 1⅜-16UN, 1-14UNS, 1⅜-12UN, 1-10UNS	¾-14, 1-11	1-26, 1-20, 1-16, 1-12, 1-10, 1⅜-9, 1-8, 1⅜-7	(TR26-TR60)x3, TR28x4, (TR65-TR110)x4, TR28x5
CTM2SC 16C21-80-2U	20.65*	M24x3.0, M30x3.5	M22x0.5, M22x0.75, M22x1.0, M23x1.25, M23x1.5, M23x2.0	1-8, 1⅜-7, 1⅝-6	⅞-32UN, ⅞-28UN, ⅞-27UNS, ⅞-24UNS, ⅞-20UNEF, 1-18UNS, 1⅜-16UN, 1-14UNS, 1⅜-12UN, 1-10UNS	¾-14, 1-11	1-26, 1-20, 1-16, 1-12, 1-10, 1⅜-9, 1-8, 1⅜-7	(TR26-TR60)x3

\* For TR inserts use for CNC program (D2+0.25mm)

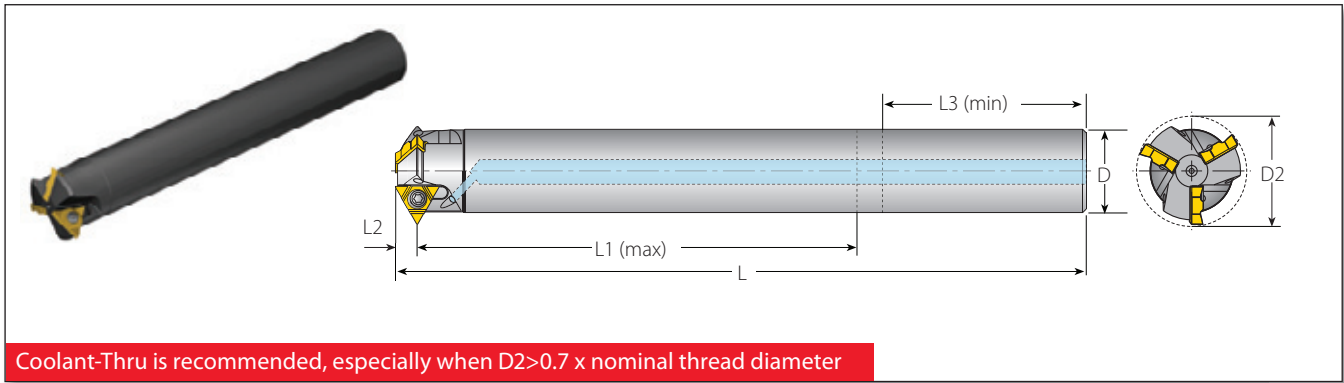

\*\* To be used only with inserts 2UIDD60TM... or 2UIDM60TM...  
For insert 2UIDD60 TM... use for CNC program (D2+0.7mm)

# TMSD Standard Toolholder - Steel Cylindrical Shank (U-Style)



## Steel Cylindrical Shank for U-Style Inserts

### Spare Parts

Insert Size	Ordering Code	Dimensions (mm)							No. of Flutes	Spare Parts	
		L	L1 (max)	L2	L3 (min)	D	D2	Z			
1/4"U	TM2SC 18C23-86-2U	166	86	5.4	40	18	23.3	2	SN2T	HK2T	
	TM3SC 20C26-105-2U	186	105	5.4	40	20	26	3			
	TM4SC 25C31-115-2U	196	115	5.4	46	25	31	4			
3/8"U	TM3SC 28C36-144-3U	222	144	8.0	60	28	36.5	3	SA3T	HK3T	

## Thread Application for U-Style Toolholders (Steel Cylindrical Shank)

Toolholder	Min. Thread Ø						
	D2	ISO Coarse	ISO Fine	UNC	UN/UNF/UNEF/UNS	BSP (G)	Partial 55°
TM2SC 18C23-86-2U	23.3	M27x3.0, M30x3.5, M36x4.0	M24x0.5, M25x0.75, M25x1.0, M25x1.25, M26x1.5, M26x2.0, M27x2.5	1 $\frac{1}{8}$ -7	1-32UN, 1-28UN, 1-27UN, 1-24UNS, 1-20UNEF, 1-18UNS, 1-16UN, 1-14UNS, 1 $\frac{1}{16}$ -12UN, 1 $\frac{1}{16}$ -10UNS, 1 $\frac{1}{16}$ -8UN	$\frac{3}{4}$ -14, 1-11	1-26, 1-20, 1 $\frac{1}{8}$ -16, 1 $\frac{1}{8}$ -12, 1 $\frac{1}{8}$ -9, 1 $\frac{1}{8}$ -7
TM3SC 20C26-105-2U	26	M30x3.5, M36x4.0	M27x0.5, M27x0.75, M28x1.0, M28x1.25, M28x1.5, M29x2.0, M30x2.5, M30x3.0	1 $\frac{1}{4}$ -7, 1 $\frac{3}{8}$ -6	1 $\frac{1}{8}$ -28UN, 1 $\frac{1}{8}$ -24UNS, 1 $\frac{1}{8}$ -20UN, 1 $\frac{1}{8}$ 18UNEF, 1 $\frac{1}{8}$ -16UN, 1 $\frac{1}{8}$ -14UNS, 1 $\frac{1}{8}$ -12UNF, 1 $\frac{3}{8}$ -10UNS, 1 $\frac{1}{16}$ -8UN	$\frac{7}{8}$ -14, 1-11	1 $\frac{1}{8}$ -26, 1 $\frac{1}{8}$ -20, 1 $\frac{3}{16}$ -16, 1 $\frac{3}{16}$ -12, 1 $\frac{3}{16}$ -8, 1 $\frac{1}{4}$ -7
TM4SC 25C31-115-2U	31	M36x4.0	M32x0.5, M32x0.75, M33x1.0, M33x1.25, M33x1.5, M34x2.0, M34x2.5, M35x3.0, M36x3.5	1 $\frac{1}{2}$ -6	1 $\frac{5}{16}$ -28UN, 1 $\frac{1}{2}$ -24UNS, 1 $\frac{1}{2}$ -20UN, 1 $\frac{1}{2}$ 18UNEF, 1 $\frac{3}{8}$ -16UN, 1 $\frac{3}{8}$ -14UNS, 1 $\frac{3}{8}$ -12UNF, 1 $\frac{3}{8}$ -10UNS, 1 $\frac{1}{16}$ -8UN	1 $\frac{1}{8}$ -11	1 $\frac{5}{16}$ -26, 1 $\frac{3}{16}$ -20, 1 $\frac{3}{8}$ -16, 1 $\frac{3}{8}$ -12, 1 $\frac{1}{16}$ -8
TM3SC 28C36-144-3U	36.5	M42.5x4.5, M48x5.0, M56x5.5, M64x6.0	M39x1.5, M40x2.5, M41x3.0, M42x3.5, M42x4.0	1 $\frac{3}{4}$ -5, 2-4.5, 2 $\frac{1}{2}$ -4	1 $\frac{5}{16}$ -16UN, 1 $\frac{1}{2}$ -14UNS, 1 $\frac{1}{16}$ -12UN, 1 $\frac{5}{8}$ -10UNS, 1 $\frac{1}{8}$ -8UN, 1 $\frac{1}{2}$ -6UN	1 $\frac{1}{4}$ -11	1 $\frac{5}{8}$ -16, 1 $\frac{5}{8}$ -12, 1 $\frac{5}{8}$ -8, 2 $\frac{1}{4}$ -6, 1 $\frac{3}{4}$ -5

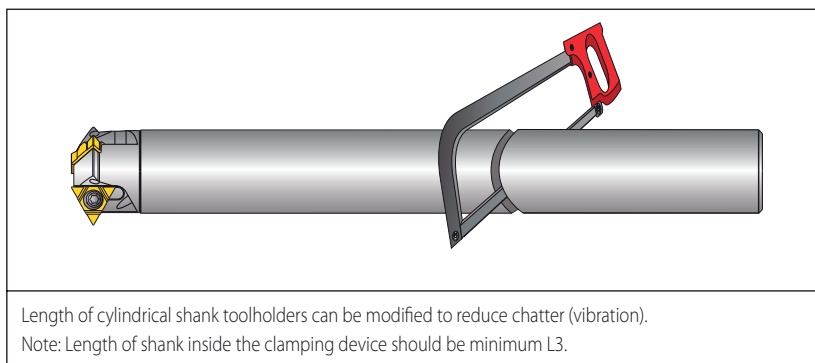

# TMSD - Shell Mill (U-Style)

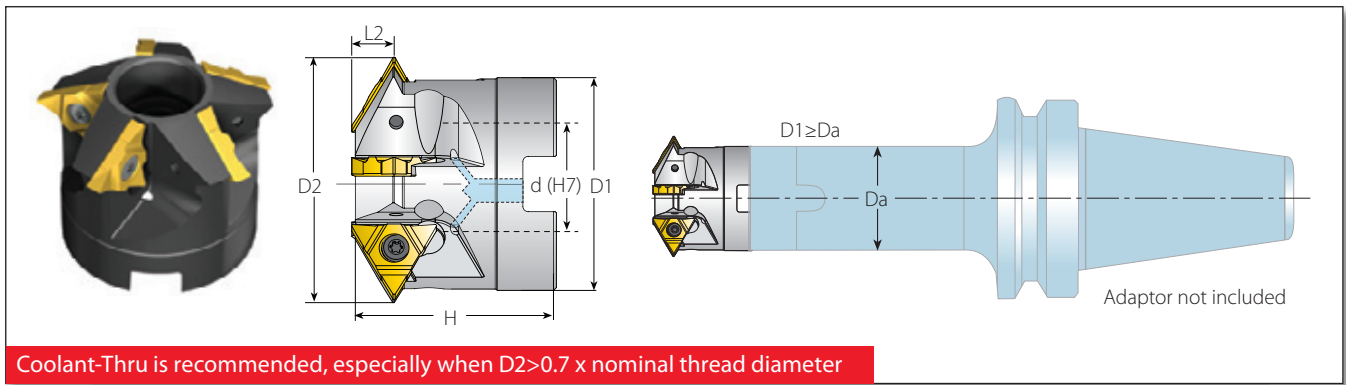

## Shell Mill for U-style Inserts

Shell Mill for U-style Inserts								Spare Parts				
Insert Size	Ordering Code	Dimensions (mm)						No. of Flutes				
IC		D1	D2	d(H7)	H	L2	Z	Insert Screw	Torx Key	Holder Screw	Holder Screwdriver	
3/8"U	TM4SC D42-16-3U	34	42	16	40	8.0	4	SN3T	HK3T	SA5T-C5 (M8x1.25x28)	TK5T	
	TM5SC D48-22-3U	40	48	22	40	8.0	5			M10x1.50x35	-	
	TM6SC D56-22-3U	48	56	22	40	8.0	6			-	-	
1/2"U	TM6SC D88-27-4U	76	88	27	50	10.8	6	SA4T	HK4T	M12x1.75x40	-	
	TM7SC D98-32-4U	85	98	32	55	10.8	7			M16x2.00x40		

## Thread Application U-Style Shell Mill



Toolholder	Min. Thread Ø						
	D2	ISO Coarse	ISO Fine	UNC	UN/UNF/UNEF/UNS	BSP (G)	Partial 55°
TM4SC D42-16-3U	42	M48x5.0, M56x5.5, M64x6.0,	M45x1.5, M45x2.0, M46x2.5, M48x3.0, M48x3.5, M48x4.0	2-4.5, 2½ - 4	1¼-16UN, 1¼-14UNS, 1½-12UN, 1½-8UN, 1½-6UN	1½ - 11	1½-16, 1½-12, 1½-8, 1½-6, 2-4.5
TM5SC D48-22-3U	48	M56x5.5, M64x6.0	M52x1.5, M52x2.0, M52x2.5, M52x3.0, M55x4.0	2¼ - 4.5, 2½ - 4	2-16UN, 2-14UN, 2-12UN, 2¼-10UNS, 2½-8UN, 2½-6UN	1¾ - 11	2-16, 2¼-12, 2¼-8, 2¼-6, 3-5, 3½-4.5, 2¼-4
TM6SC D56-22-3U	56	M64x6.0	M60x1.5, M60x2.0, M60x2.5, M60x3.0, M64x4.0	2½ - 4	2¾-16UN, 2¾-14UN, 2¾-12UN, 2½-10UNS, 2¾-8UN, 2½-6UN	2 - 11	2½-16, 2½-12, 2½-8, 2¾-6, 3-5, 3½-4.5, 4¼-4
TM6SC D88-27-4U	88	-	M95x6.0, M130x8	4 - 4	4¼-4UN	3½ - 11	4-3, 4¼-4
TM7SC D98-32-4U	98	-	M105x6.0, M130x8	-	4¼-4UN	4 - 11	4¼-4

TMSD

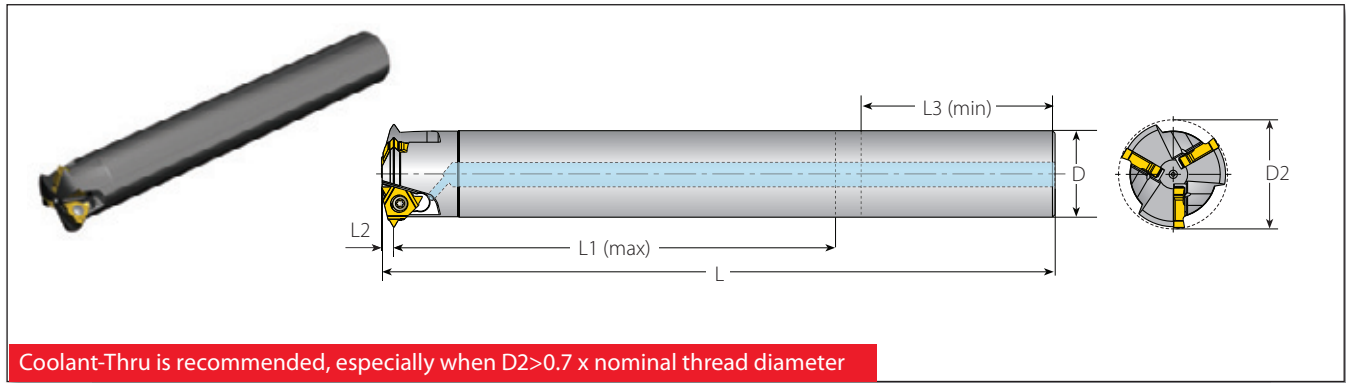
## TMSD Standard Toolholder - Steel Cylindrical Shank (A-Style)



### Steel Cylindrical Shank for A-Style Inserts

Steel Cylindrical Shank for A-Style Inserts									Spare Parts	
Insert Size	Ordering Code	Dimensions (mm)						No. of Flutes		
IC		L	L1 (max)	L2	L3 (min)	D	D2	Z	Insert Screw	Torx Key
1/4"A	TM3SC 20C26-105-2A	184	105	3.0	40	20	26	3	SN2T	HK2T
3/8"A	TM3SC 28C35-144-3A	218	144	4.0	46	28	35.3	3	SA3T	HK3T

### Thread Application for A-Style Toolholders (Steel Cylindrical Shank)

Toolholder	Min. Thread Ø					
	D2	ISO Coarse	ISO Fine	UNC	UN/UNF/UNEF/UNS	BSP (G)
TM3SC 20C26-105-2A	26	-	M28x1.5, M29x2.0, M30x2.5, M30x3.0	-	1 1/8-16UN, 1 1/8-14UNS, 1 3/16-12UN, 1 1/4-10UNS, 1 3/16-8UN	-
TM3SC 28C35-144-3A	35.3	-	M38x2.0, M39x2.5, M39x3.0, M40x4.0	-	1 1/16-12UN, 1 1/8-10UNS, 1 1/8-8UN, 1 1/8-6UN	-

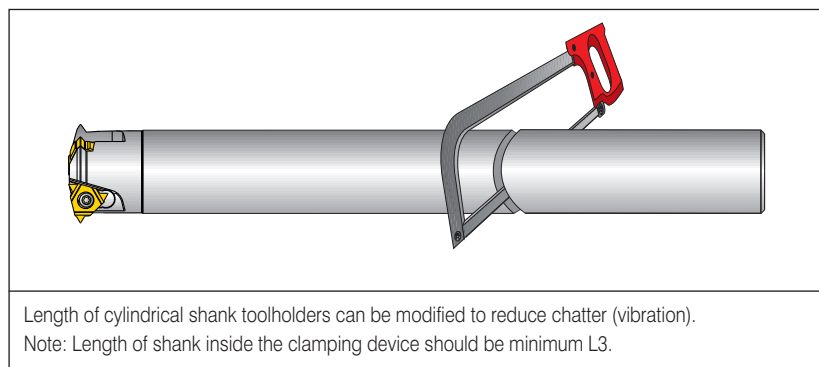

Length of cylindrical shank toolholders can be modified to reduce chatter (vibration).  
 Note: Length of shank inside the clamping device should be minimum L3.



## Recommended Grades, Cutting Speeds Vc [m/min] and Feed f [mm/tooth]

Material Group	Vardex No.	Material	Hardness Brinell HB	Vc [mm/min]		Feed* f [mm/tooth] by Cutting Dia. (D2)			
				VBX	VTX	13-23	24-42	Shell Mill	
<b>P</b> Steel	1	Unalloyed steel	Low carbon (C=0.1-0.25%)	125	100-210	90-180	0.20-0.32	0.30-0.50	0.30-0.75
	2		Medium carbon (C=0.25-0.55%)	150	100-180	90-170	0.20-0.32	0.30-0.50	0.30-0.75
	3		High Carbon (C=0.55-0.85%)	170	100-170	90-160	0.15-0.23	0.25-0.35	0.25-0.52
	4	Low alloy steel (alloying elements ≤5%)	Non hardened	180	60-90	90-155	0.17-0.28	0.28-0.45	0.28-0.67
	5		Hardened	275	80-150	80-160	0.15-0.28	0.25-0.45	0.25-0.67
	6		Hardened	350	70-140	70-150	0.15-0.25	0.25-0.40	0.25-0.60
	7	High alloy steel (alloying elements >5%)	Annealed	200	60-130	70-115	0.15-0.22	0.20-0.30	0.20-0.45
	8		Hardened	325	70-110	60-100	0.13-0.21	0.18-0.30	0.18-0.45
	9	Cast steel	Low alloy (alloying elements <5%)	200	100-170	100-170	0.15-0.22	0.20-0.30	0.20-0.45
	10		High alloy (alloying elements >5%)	225	70-120	70-130	0.12-0.22	0.17-0.30	0.17-0.45
<b>M</b> Stainless Steel	11	Stainless steel Ferritic	Non hardened	200	100-170	120-180	0.15-0.22	0.22-0.34	0.22-0.50
	12		Hardened	330	100-170	120-180	0.16-0.23	0.21-0.32	0.21-0.48
	13	Stainless steel Austenitic	Austenitic	180	70-140	100-140	0.15-0.25	0.25-0.40	0.25-0.60
	14		Super Austenitic	200	70-140	100-140	0.12-0.20	0.17-0.26	0.17-0.39
	15	Stainless steel Cast Ferritic	Non hardened	200	70-140	100-140	0.16-0.24	0.25-0.37	0.25-0.55
	16		Hardened	330	70-140	100-140	0.12-0.20	0.17-0.26	0.17-0.39
	17	Stainless steel Cast austenitic	Austenitic	200	70-120	100-120	0.15-0.22	0.20-0.30	0.20-0.45
	18		Hardened	330	70-120	100-120	0.12-0.20	0.17-0.26	0.17-0.39
<b>K</b> Cast Iron	28	Malleable Cast iron	Ferritic (short chips)	130	60-130	100-120	0.16-0.24	0.25-0.37	0.25-0.55
	29		Pearlitic (long chips)	230	60-120	80-100	0.15-0.22	0.20-0.30	0.20-0.45
	30	Grey cast iron	Low tensile strength	180	60-130	80-100	0.15-0.22	0.22-0.34	0.22-0.50
	31		High tensile strength	260	60-100	80-100	0.15-0.22	0.20-0.30	0.20-0.45
	32	Nodular SG iron	Ferritic	160	60-125	80-100	0.10-0.20	0.15-0.25	0.15-0.37
	33		Pearlitic	260	50-90	60-90	0.15-0.22	0.20-0.30	0.20-0.45
<b>N<sub>(K)</sub></b> Non-Ferrous Metals	34	Aluminium alloys Wrought	Non aging	60	100-250		0.30-0.50	0.60-1.00	0.60-1.50
	35		Aged	100	100-180		0.28-0.50	0.50-0.90	0.50-1.20
	36	Aluminium alloys	Cast	75	150-400		0.28-0.50	0.50-0.90	0.50-1.20
	37		Cast & aged	90	150-280		0.25-0.40	0.40-0.60	0.40-0.90
	38	Aluminium alloys	Cast Si 13-22%	130	80-150		0.28-0.50	0.50-0.90	0.50-1.20
	39	Copper and Copper alloys	Brass	90	120-210	100-200	0.30-0.50	0.60-1.00	0.60-1.50
40	Bronze and non leaded copper		100	120-210	100-200	0.28-0.50	0.50-0.90	0.50-1.20	
<b>S<sub>(M)</sub></b> Heat Resistant Material	19	High temperature alloys	Annealed (Iron based )	200	20-45	20-40	0.09-0.15	0.12-0.22	0.12-0.33
	20		Aged (Iron based)	280	20-30	20-30	0.07-0.13	0.10-0.20	0.10-0.30
	21		Annealed (Nickel or Cobalt based)	250	15-20	15-20	0.08-0.15	0.08-0.20	0.08-0.30
	22		Aged (Nickel or Cobalt based)	350	10-15	10-15	0.08-0.15	0.08-0.20	0.08-0.30
	23	Titanium alloys	Pure 99.5 Ti	400Rm	70-140	70-120	0.07-0.13	0.10-0.20	0.10-0.30
24	αβ alloys		1050Rm	20-50	20-50	0.07-0.13	0.10-0.20	0.10-0.30	
<b>H<sub>(K)</sub></b> Hardened Material	25	Extra hard steel	Hardened & tempered	45-50HRC	15-45	15-45	0.05-0.12	0.05-0.18	0.05-0.27
	26			51-55HRC	15-40	15-40	0.05-0.12	0.05-0.18	0.05-0.27

\* When using a Shell Mill holder, Feed can be increased by 50%

### Grades

Grade	Application
<b>VBX</b>	TiCN coated carbide grade. Excellent grade for steels and general use.
<b>VTX</b>	TiAlN coated carbide grade. Ideal for Stainless Steels.

U Style



A Style



Mini-L Style







# TM Solid

Solid Carbide Thread Milling Tools

> Tools

> Technical Data



# TM SOLID CARBIDE

- **Helicool** - Helical Flute with Axial Coolant Thru ..... Page 292
- **Helicool R (HCR)** - Helical Flute with Radial Coolant Thru ..... Page 297
- **Helicool C (HCC)** - Helical Flute with Axial Coolant Thru and Chamfer ..... Page 298
- **HTC (Thriller)** - Drill, Chamfer and Thread with Coolant Thru ..... Page 299
- **Helical** - Helical Flute without Coolant Thru ..... Page 300
- **Deep Threading** - Straight Flutes for Deep Holes ..... Page 304
- **MilliPro** - Miniature Thread Mills ..... Page 305
- **MilliPro Dental** - Miniature Thread Mills for Dental Implants ..... Page 308
- **MilliPro EL** - Miniature Thread Mills, Extra Long Tools ..... Page 309
- **MilliPro HD** - Miniature Thread Mills for Hard Materials ..... Page 310
- **Straight** - Straight Flute ..... Page 312
- **Grades and Their Applications** ..... Page 317
- **Cutting Speeds and Feeds** ..... Page 318

## TM Solid Carbide

<b>HC</b>		<b>10</b>	<b>082</b>	<b>L15</b>	<b>-</b>	<b>I</b>	<b>1.50</b>	<b>ISO</b>	<b>TM</b>		<b>VTH</b>
<b>1</b>	<b>2</b>	<b>3</b>	<b>4</b>	<b>5</b>		<b>6</b>	<b>7</b>	<b>8</b>	<b>9</b>	<b>10</b>	<b>11</b>

1 - Line	2 - No. of Teeth	3 - Shank Dia.	4 - Cutting Dia.	5 - Tool Cutting Length	6 - Type of Tool
HC - Helicool HCR - Helicool R HCC - Helicool C H - Helical S - Straight Flutes D - Deep Threading or MilliPro	1T - 1 Tooth 3T - 3 Teeth (MilliPro) 2L - 2 Teeth LH (MilliPro HD)	03 - 3.0 mm 04 - 4.0 06 - 6.0 08 - 8.0 10 - 10.0 12 - 12.0 14 - 14.0 16 - 16.0 18 - 18.0 20 - 20.0	0.7 - 19.9 mm	Up to 3Do	E - External I - Internal EI - External + Internal

7 - Pitch	8 - Standard	9 - System	10 - No. of Flutes	11 - Carbide Grade
Full Profile - Pitch Range mm      tpi 0.25-6.0      80-4.5 Partial Profile - Pitch Range mm      tpi TA      0.5-0.8      32-56 TB      0.5-1.0      24-56 TC      1.0-1.50      16-24 TD      1.0-1.75      14-24 TF      0.5-1.25      20-48	ISO - ISO Metric UN - American UN UNC - UN Coarse UNF - UN Fine UNEF - UN Extra Fine UNJ - UNJ MJ - MJ BSW - Whit. Coarse BSP - BSP BSF - Whit. Fine BSPT - BSPT NPT - NPT NPTF - NPTF PG - PG	TM TML - Extra Long	3 - 3 Flutes 5 - 5 Flutes Straight Flute, when two options are available	VTS VTH

## HTC - Thriller

<b>HTC</b>	<b>M6</b>	<b>1.0</b>	<b>2D</b>	<b>VTN</b>
<b>1</b>	<b>2</b>	<b>3</b>	<b>4</b>	<b>5</b>

1 - Line	2 - Thread Diameter	3 - Pitch	4 - Thread Length	5 - Carbide Grade
HTC - Thriller	M6 - M12	1 - 1.75mm	2D 2.5D	VTN VTS

# A Tool for EVERY Thread Milling Job!

## Miniature Threads

### MilliPro

MilliPro &  
MilliPro EL  
From M1.6x0.35 (1-72UNF)



MilliPro HD  
Up to 62 HRC

MilliPro Dental  
From M1.0x0.25 (0-80UNF)

## Long Thread Deep Threading

Full Profile



Partial Profile

Up to 3XDo

## Normal Use Straight Flutes



From M4.5x0.75 (No.8-36UNF)

## Heavy Duty Helicool



From M3x0.5 (No.10-32UNF)

## Radial Coolant Helicool-R (HCR)



From M6x1.0

## Helicool and Chamfer Helicool-C (HCC)



From M6x1.0

## Economical Tool Helical



From M3x0.5 (No.8-36UNF)

## Drill, Thread and Chamfer HTC



From M6x1.0

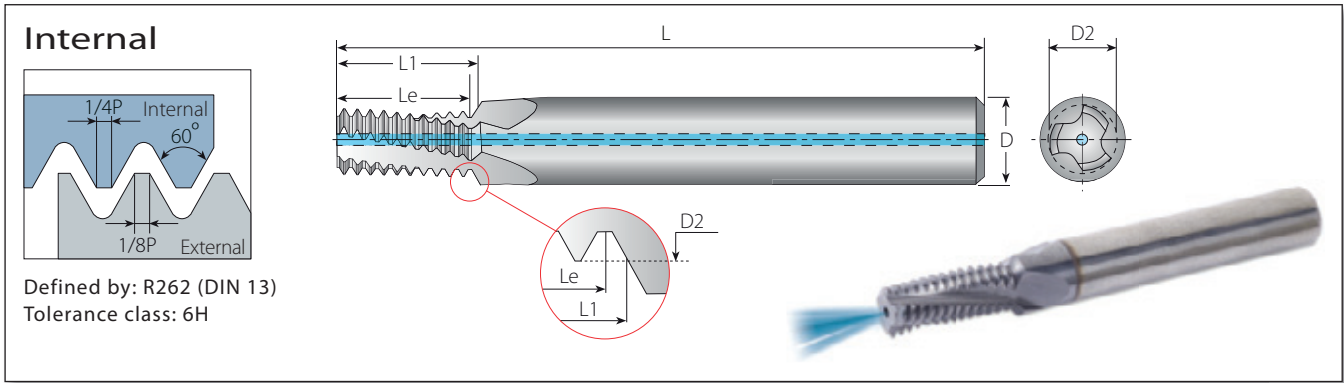

Helical Flutes with Thru-Hole Coolant

1.5 x Do (L1 ≤ 1.5 x Thread Diameter)

Thread		Pitch	Ordering Code	Dimensions mm				No. of Flutes	Teeth	Bore Dia.*	
M Coarse	M Fine	mm	Internal	D	D2	L	Le	L1	Z	Zt	mm
M3x0.5	M3.5-M16x0.5	0.5	HC04024L04-I0.50ISO TM...	4	2.40	45	4.5	4.7	3	9	2.5
M4x0.7		0.7	HC04031L06-I0.70ISO TM...	4	3.15	45	6.3	6.6	3	9	3.3
M5x0.8		0.8	HC04039L07-I0.80ISO TM...	4	3.90	45	7.2	7.6	3	9	4.2
M6x1.0	M8-M40x1.0	1.0	HC06048L09-I1.00ISO TM...	6	4.80	57	9.0	9.5	3	9	5.0
M8x1.25		1.25	HC08065L13-I1.25ISO TM...	8	6.50	61	12.5	13.1	3	10	6.8
M10x1.5	M12-M48x1.5	1.5	HC10082L15-I1.50ISO TM...	10	8.20	73	15.0	15.7	3	10	8.5
M12x1.75		1.75	HC10099L18-I1.75ISO TM...	10	9.90	73	17.5	18.4	4	10	10.2
M14x2.0	M17-M80x2.0	2.0	HC12116L21-I2.00ISO TM...	12	11.60	73	20.0	21.0	4	10	12.0
M16x2.0	M17-M80x2.0	2.0	HC14136L25-I2.00ISO TM...	14	13.60	92	24.0	25.0	4	12	14.0

Helical Flutes with Thru-Hole Coolant

2 x Do (L1 ≤ 2 x Thread Diameter)

Thread		Pitch	Ordering Code	Dimensions mm				No. of Flutes	Teeth	Bore Dia.*	
M Coarse	M Fine	mm	Internal	D	D2	L	Le	L1	Z	Zt	mm
M3x0.5	M3.5-M16x0.5	0.5	HC04024L06-I0.50ISO TM...	4	2.40	45	6.0	6.2	3	12	2.5
	M4x0.5	0.5	HC04032L08-I0.50ISO TM...	4	3.20	45	8.0	8.2	3	16	3.5
	M5x0.5	0.5	HC06042L10-I0.50ISO TM...	6	4.20	57	10.0	10.2	3	20	4.5
M4x0.7		0.7	HC04031L08-I0.70ISO TM...	4	3.15	45	8.4	8.7	3	12	3.3
	M6x0.75	0.75	HC06050L12-I0.75ISO TM...	6	5.00	57	12.0	12.4	3	16	5.3
M5x0.8		0.8	HC04039L10-I0.80ISO TM...	4	3.90	45	10.4	10.8	3	13	4.2
M6x1.0	M8-M40x1.0	1.0	HC06048L12-I1.00ISO TM...	6	4.80	57	12.0	12.5	3	12	5.0
	M8x1.0	1.0	HC08067L16-I1.00ISO TM...	8	6.70	61	16.0	16.5	3	16	7.0
	M10x1.0	1.0	HC10087L20-I1.00ISO TM...	10	8.70	73	20.0	20.5	3	20	9.0
	M12x1.0	1.0	HC12107L24-I1.00ISO TM...	12	10.70	73	24.0	24.5	4	24	11.0
M8x1.25		1.25	HC08065L16-I1.25ISO TM...	8	6.50	61	16.2	16.9	3	13	6.8
	M10x1.25	1.25	HC10085L20-I1.25ISO TM...	10	8.50	73	20.0	20.6	3	16	8.8
M10x1.5	M12-M48x1.5	1.5	HC10082L20-I1.50ISO TM...	10	8.20	73	19.5	20.2	3	13	8.5
	M12x1.5	1.5	HC10099L24-I1.50ISO TM...	10	9.90	73	24.0	24.7	4	16	10.5
	M14x1.5	1.5	HC12119L29-I1.50ISO TM...	12	11.90	80	28.5	29.2	4	19	12.5
	M16x1.5	1.5	HC14139L32-I1.50ISO TM...	14	13.90	92	31.5	32.2	4	21	14.5
M12x1.75		1.75	HC10099L25-I1.75ISO TM...	10	9.90	73	24.5	25.4	4	14	10.2
M14x2.0	M17-M80x2.0	2.0	HC12116L29-I2.00ISO TM...	12	11.60	80	28.0	29.0	4	14	12.0
M16x2.0	M17-M80x2.0	2.0	HC14136L33-I2.00ISO TM...	14	13.60	92	32.0	33.0	4	16	14.0
M18x2.5		2.5	HC16148L36-I2.50ISO TM...	16	14.80	92	35.0	36.2	4	14	15.5
M20x2.5		2.5	HC18171L41-I2.50ISO TM...	18	17.10	102	40.0	41.2	4	16	17.5
M24x3.0		3.0	HC20199L49-I3.00ISO TM...	20	19.90	102	48.0	49.5	4	16	21.0

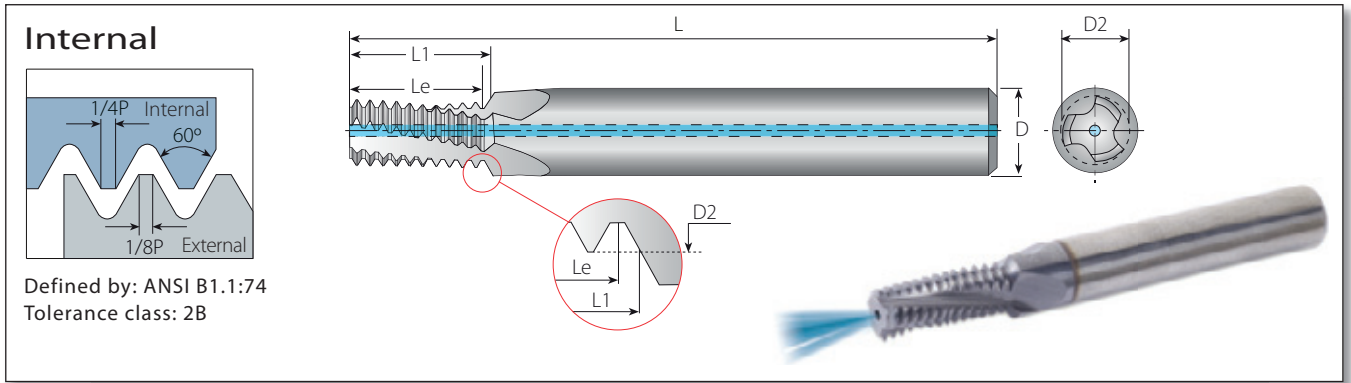

Internal

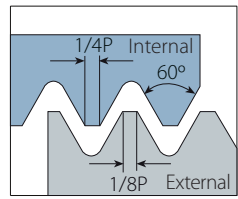

Defined by: ANSI B1.1:74  
Tolerance class: 2B

Helical Flutes with Thru-Hole Coolant

1.5 x Do (L1 ≤ 1.5 x Thread Diameter)

Thread			Pitch	Ordering Code	Dimensions mm					No. of Flutes	Teeth	Bore Dia.*
UNC	UNF	UNEF	tpi	Internal	D	D2	L	Le	L1	Z	Zt	mm
No.10-24	5/16", 3/8"x24	9/16"-11/16"x24	24	HC04035L07-I24UNC TM...	4	3.58	45	7.4	7.9	3	7	3.8
No.12-24	5/16", 3/8"x24	9/16"-11/16"x24	24	HC06041L08-I24UNC TM...	6	4.15	57	8.5	9.0	3	8	4.5
1/4"x20	7/16", 1/2"x20	3/4"-1"x20	20	HC06048L09-I20UNC TM...	6	4.88	57	8.9	9.5	3	7	5.2
5/16"x18	9/16", 5/8"x18	11/16"-1 1/16" x18	18	HC08061L11-I18UNC TM...	8	6.15	61	11.3	12.0	3	8	6.5
3/8"x16	3/4"x16		16	HC08076L15-I16UNC TM...	8	7.65	61	14.3	15.1	3	9	8.0
7/16"x14	7/8"x14		14	HC10090L17-I14UNC TM...	10	9.00	73	16.3	17.2	3	9	9.3
1/2"x13			13	HC12104L20-I13UNC TM...	12	10.35	73	19.5	20.5	4	10	10.8
9/16"x12	1"-1 1/2"x12		12	HC12118L22-I12UNC TM...	12	11.80	73	21.2	22.2	4	10	12.3

Helical Flutes with Thru-Hole Coolant

2 x Do (L1 ≤ 2 x Thread Diameter)

Thread			Pitch	Ordering Code	Dimensions mm					No. of Flutes	Teeth	Bore Dia.*
UNC	UNF	UNEF	tpi	Internal	D	D2	L	Le	L1	Z	Zt	mm
	No.10-32	No.12-3/8"x32	32	HC04038L09-I32UNF TM...	4	3.80	45	9.5	9.9	3	12	4.0
		No.12-3/8"x32	32	HC06044L11-I32UNEF TM...	6	4.40	57	11.1	11.5	3	14	4.7
	No.12, 1/4"x28	7/16", 1/2"x28	28	HC06043L11-I28UNF TM...	6	4.30	57	10.9	11.3	3	12	4.6
	1/4"x28	7/16", 1/2"x28	28	HC06052L13-I28UNF TM...	6	5.15	57	12.7	13.1	3	14	5.5
		7/16", 1/2"x28	28	HC10099L22-I28UNEF TM...	10	9.90	73	21.8	22.2	3	24	10.2
No.10-24	5/16", 3/8"x24	9/16"-11/16"x24	24	HC04035L10-I24UNC TM...	4	3.58	45	9.5	10.0	3	9	3.8
No.12-24	5/16", 3/8"x24	9/16"-11/16"x24	24	HC06041L11-I24UNC TM...	6	4.15	57	10.6	11.1	3	10	4.5
	5/16", 3/8"x24	9/16"-11/16"x24	24	HC08066L16-I24UNF TM...	8	6.68	61	15.9	16.4	3	15	6.8
	3/8"x24	9/16"-11/16"x24	24	HC10082L19-I24UNF TM...	10	8.20	73	19.0	19.6	3	18	8.5
		9/16"-11/16"x24	24	HC14129L29-I24UNEF TM...	14	12.90	92	28.6	29.1	4	27	13.2
1/4"x20	7/16", 1/2"x20	3/4"-1"x20	20	HC06048L13-I20UNC TM...	6	4.88	57	12.7	13.3	3	10	5.2
	7/16", 1/2"x20	3/4"-1"x20	20	HC10096L22-I20UNF TM...	10	9.60	73	21.6	22.2	3	17	9.8
	1/2"x20	3/4"-1"x20	20	HC12111L26-I20UNF TM...	12	11.10	80	25.4	26.0	3	20	11.5
		3/4"-1"x20	20	HC18174L38-I20UNEF TM...	18	17.40	102	38.1	38.7	4	30	17.8
5/16"x18	9/16", 5/8"x18	11/16"-1 1/16"x18	18	HC08061L16-I18UNC TM...	8	6.15	61	15.5	16.2	3	11	6.5
	9/16", 5/8"x18	11/16"-1 1/16"x18	18	HC14125L28-I18UNF TM...	14	12.50	92	28.2	28.9	4	20	12.8
	5/8"x18	11/16"-1 1/16"x18	18	HC16141L31-I18UNF TM...	16	14.10	92	31.0	31.7	4	22	14.5
3/8"x16	3/4"x16		16	HC08076L19-I16UNC TM...	8	7.65	61	19.0	19.8	3	12	8.0
	3/4"x16		16	HC18170L38-I16UNF TM...	18	17.00	102	38.1	38.8	4	24	17.5
7/16"x14	7/8"x14		14	HC10090L22-I14UNC TM...	10	9.00	73	21.8	22.7	3	12	9.3
	7/8"x14		14	HC20199L44-I14UNF TM...	20	19.90	102	43.5	44.4	4	24	20.5
1/2"x13			13	HC12104L26-I13UNC TM...	12	10.35	80	25.4	26.4	4	13	10.8
9/16"x12	1"-1 1/2"x12		12	HC12118L28-I12UNC TM...	12	11.80	80	27.5	28.6	4	13	12.3
	1"-1 1/2"x12		12	HC20199L51-I12UNF TM...	20	19.90	102	50.8	51.9	4	24	23.5
5/8"x11			11	HC14131L33-I11UNC TM...	14	13.10	92	32.3	33.5	4	14	13.5
3/4"x10			10	HC16159L39-I10UNC TM...	16	15.90	92	38.1	39.4	4	15	16.5
7/8"x9			9	HC20190L46-I9UNC TM...	20	19.00	102	45.2	46.6	4	16	19.5
1"x8			8	HC20199L52-I8UNC TM...	20	19.90	102	50.8	52.4	4	16	22.0

\*Bore Diameter applies to smallest thread Dia.

Maximum thread length = L1 · Pitch / 4

**External / Internal**

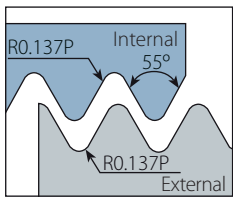

Defined by: B.S.84:1956,  
DIN 259, ISO228/1:1982  
Tolerance class: Medium class A

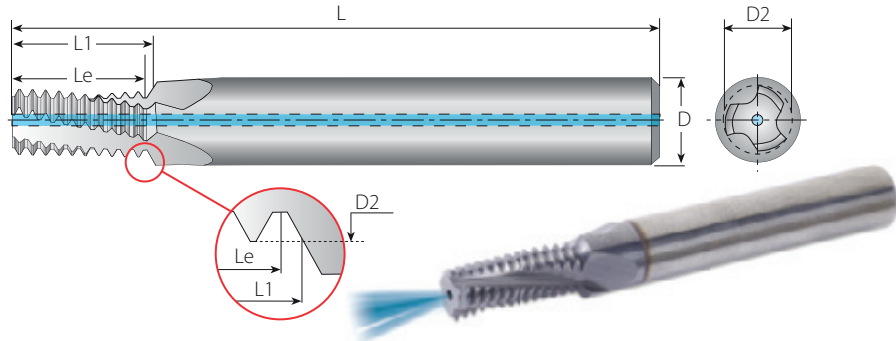

**Helical Flutes with Thru-Hole Coolant**

**2 x Do (L1 ≤ 2 x Thread Diameter)**

Thread		Pitch	Ordering Code	Dimensions mm					No. of Flutes	Teeth	Bore Dia.*
BSW	BSF	tpi	External / Internal	D	D2	L	Le	L1	Z	Zt	mm
	1/4"x26	26	HC06050L13-EI26BSF TM...	6	5.00	57	12.7	13.2	3	13	5.3
	5/16"x22	22	HC08063L16-EI22BSF TM...	8	6.35	61	16.2	16.7	3	14	6.7
1/4"x20	3/8"x20	20	HC06044L13-EI20BSW TM...	6	4.45	57	12.7	13.3	3	10	5.0
	3/8"x20	20	HC08076L19-EI20BSF TM...	8	7.65	61	19.0	19.7	3	15	8.2
5/16"x18	7/16"x18	18	HC06058L16-EI18BSW TM...	6	5.85	57	15.5	16.2	3	11	6.5
	7/16"x18	18	HC10092L23-EI18BSF TM...	10	9.20	73	22.6	23.3	3	16	9.7
3/8"x16	1/2", 9/16"x16	16	HC08072L19-EI16BSW TM...	8	7.20	61	19.0	19.8	3	12	7.9
	1/2", 9/16"x16	16	HC12105L26-EI16BSF TM...	12	10.50	80	25.4	26.2	4	16	11.1
	9/16"x16	16	HC14122L29-EI16BSF TM...	14	12.15	92	28.6	29.4	4	18	12.6
7/16"x14	5/8", 11/16"x14	14	HC10085L22-EI14BSW TM...	10	8.50	73	21.8	22.7	3	12	9.2
	5/8", 11/16"x14	14	HC14134L31-EI14BSF TM...	14	13.40	92	30.8	31.7	4	17	14.0
	11/16"x14	14	HC16150L35-EI14BSF TM...	16	15.00	92	34.5	35.4	4	19	15.6
1/2"x12	3/4"x12	12	HC10096L26-EI12BSW TM...	10	9.65	73	25.4	26.5	3	12	10.5
9/16"x12	3/4"x12	12	HC12113L28-EI12BSW TM...	12	11.25	80	27.5	28.6	4	13	12.1
	3/4"x12	12	HC18162L39-EI12BSF TM...	18	16.20	102	38.1	39.2	4	18	16.8
5/8"x11	7/8"x11	11	HC14126L33-EI11BSW TM...	14	12.60	92	32.3	33.5	4	14	13.4
	11/16"x11	11	HC16142L35-EI11BSW TM...	16	14.20	92	34.6	35.8	4	15	15.0

**BSPT**

**External / Internal**

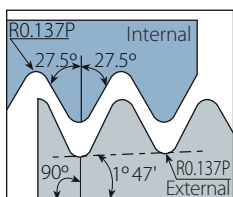

Defined by: B.S.21:1985  
Tolerance class: Standard BSPT

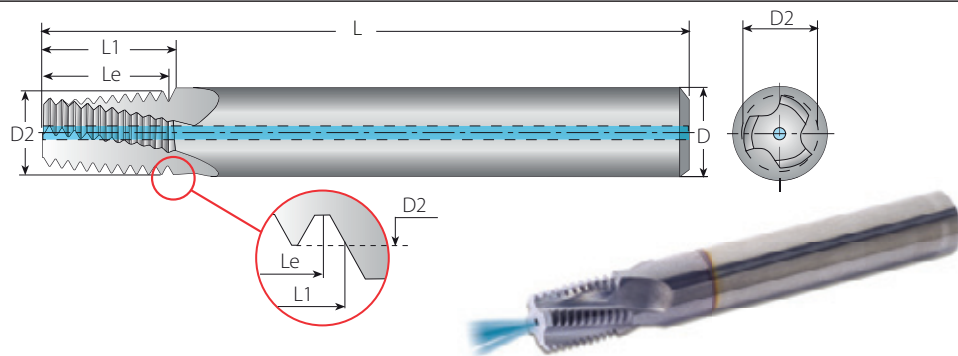

**Helical Flutes with Thru-Hole Coolant**

Thread	Pitch	Ordering Code	Dimensions mm					No. of Flutes	Teeth	Bore Dia.*
Standard	tpi	External / Internal	D	D2	L	Le	L1	Z	Zt	mm
1/16"x28	28	HC06059L10-EI28BSPT TM...	6	5.90	57	10.0	10.2	3	11	6.7
1/8"x28	28	HC08076L10-EI28BSPT TM...	8	7.65	61	10.0	10.2	3	11	8.7
1/4"x19	19	HC10099L15-EI19BSPT TM...	10	9.90	73	14.7	15.4	3	11	11.8
3/8"x19	19	HC12111L15-EI19BSPT TM...	12	11.15	73	14.7	15.4	4	11	15.2
1/2", 3/4"x14	14	HC16142L22-EI14BSPT TM...	16	14.25	92	21.8	22.7	4	12	19.0
1", 1 1/2", 2", 2 1/2"x11	11	HC20196L28-EI11BSPT TM...	20	19.60	102	27.7	28.9	4	12	30.7



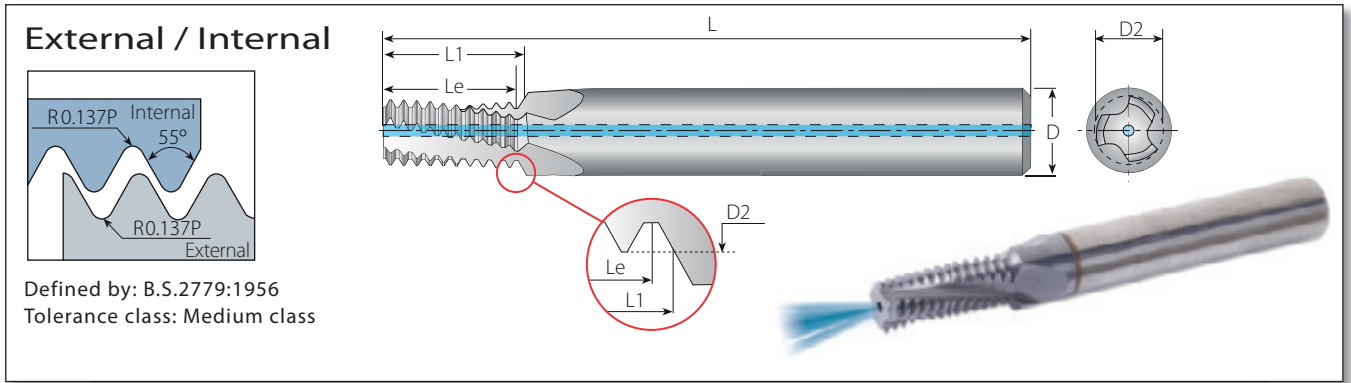

**Helical Flutes with Thru-Hole Coolant**

**1.5 x Do (L1 ≤ 1.5 x Thread Diameter)**

Thread	Pitch	Ordering Code	Dimensions mm					No. of Flutes	Teeth	Bore Dia.*
Standard	tpi	External / Internal	D	D2	L	Le	L1	Z	Zt	mm
1/16", 1/8"x28	28	HC08064L12-EI28BSP TM...	8	6.40	61	11.8	12.2	3	13	6.7
1/8"x28	28	HC10082L15-EI28BSP TM...	10	8.20	73	14.5	15.0	3	16	8.7
1/4", 3/8"x19	19	HC12110L20-EI19BSP TM...	12	11.00	80	20.0	20.7	4	15	11.8
3/8"x19	19	HC16145L26-EI19BSP TM...	16	14.50	92	25.4	26.1	4	19	15.2
1"-4"x11	11	HC20199L42-EI11BSP TM...	20	19.90	102	41.6	42.7	4	18	30.7

**Helical Flutes with Thru-Hole Coolant**

**2 x Do (L1 ≤ 2 x Thread Diameter)**

Thread	Pitch	Ordering Code	Dimensions mm					No. of Flutes	Teeth	Bore Dia.*
Standard	tpi	External / Internal	D	D2	L	Le	L1	Z	Zt	mm
1/16", 1/8"x28	28	HC08064L15-EI28BSP TM...	8	6.40	61	15.4	15.9	3	17	6.7
1/8"x28	28	HC10082L19-EI28BSP TM...	10	8.20	73	19.0	19.5	3	21	8.7
1/4", 3/8"x19	19	HC12110L27-EI19BSP TM...	12	11.00	80	26.7	27.4	4	20	11.8
3/8"x19	19	HC16145L34-EI19BSP TM...	16	14.50	92	33.4	34.1	4	25	15.2
1/2"-7/8"x14	14	HC18179L42-EI14BSP TM...	18	17.90	102	41.7	42.6	4	23	19.0

\*Bore Diameter applies to smallest thread Dia.

Maximum thread length =  $L1 - \frac{\text{Pitch}}{4}$

# NPT

# Helicool

## External / Internal

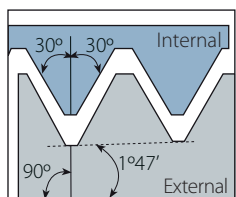

Defined by: USAS B2.1:1968  
Tolerance class: Standard NPT

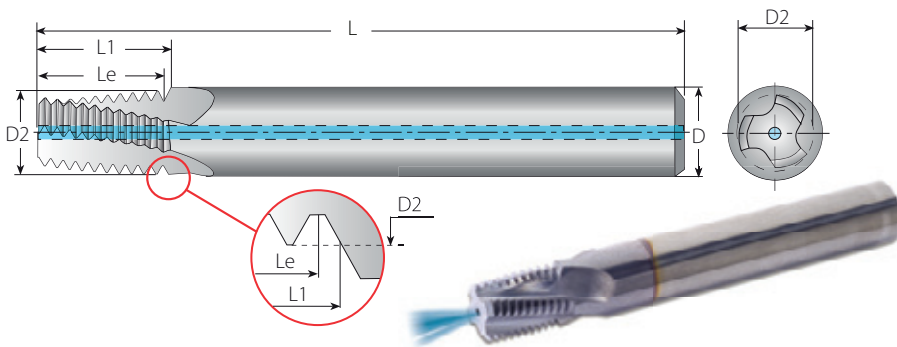

## Helical Flutes with Thru-Hole Coolant

Thread	Pitch	Ordering Code	Dimensions mm					No. of Flutes	Teeth	Bore Dia.*
Standard	tpi	External / Internal	D	D2	L	Le	L1	Z	Zt	mm
1/16"x27	27	HC06059L09-EI27NPT TM...	6	5.90	57	9.4	9.9	3	10	6.3
1/8"x27	27	HC08076L09-EI27NPT TM...	8	7.65	61	9.4	9.9	3	10	8.5
1/4"x18	18	HC10099L14-EI18NPT TM...	10	9.90	73	14.1	14.8	3	10	11.1
3/8"x18	18	HC12111L14-EI18NPT TM...	12	11.15	73	14.1	14.8	4	10	14.5
1/2", 3/4"x14	14	HC16142L19-EI14NPT TM...	16	14.25	92	18.1	19.0	4	10	17.7, 23.0
1", 1 1/4", 1 1/2", 2"x11.5	11.5	HC20196L23-EI11.5NPT TM...	20	19.60	102	22.1	23.2	4	10	29.0, 37.7, 44.0, 56.0
2 1/2", 3"x8	8	HC20196L33-EI8NPT TM...	20	19.60	102	31.7	33.3	4	10	66.5, 82.1

# NPTF

# Helicool

## External / Internal

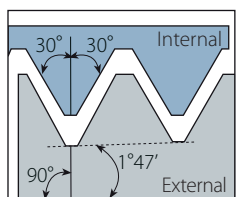

Defined by: ANSI 1.20.3-1976  
Tolerance class: Standard NPTF

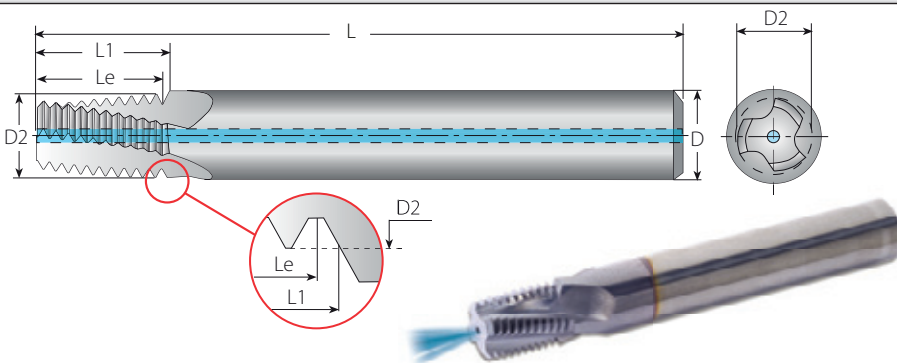

## Helical Flutes with Thru-Hole Coolant

Thread	Pitch	Ordering Code	Dimensions mm					No. of Flutes	Teeth	Bore Dia.*
Standard	tpi	External / Internal	D	D2	L	Le	L1	Z	Zt	mm
1/16"x27	27	HC06059L09-EI27NPTF TM...	6	5.90	57	9.4	9.9	3	10	6.3
1/8"x27	27	HC08076L09-EI27NPTF TM...	8	7.65	61	9.4	9.9	3	10	8.4
1/4"x18	18	HC10099L14-EI18NPTF TM...	10	9.90	73	14.1	14.8	3	10	11.1
3/8"x18	18	HC12111L14-EI18NPTF TM...	12	11.15	73	14.1	14.8	4	10	14.7
1/2", 3/4"x14	14	HC16142L19-EI14NPTF TM...	16	14.25	92	18.1	19.0	4	10	17.9, 23.4
1", 1 1/4", 1 1/2", 2"x11.5	11.5	HC20196L23-EI11.5NPTF TM...	20	19.60	102	22.1	23.2	4	10	29.0, 37.7, 43.7, 55.6
2 1/2", 3"x8	8	HC20196L33-EI8NPTF TM...	20	19.60	102	31.7	33.3	4	10	66.3, 82.1

# ISO Metric

# Helicool-R (HCR)

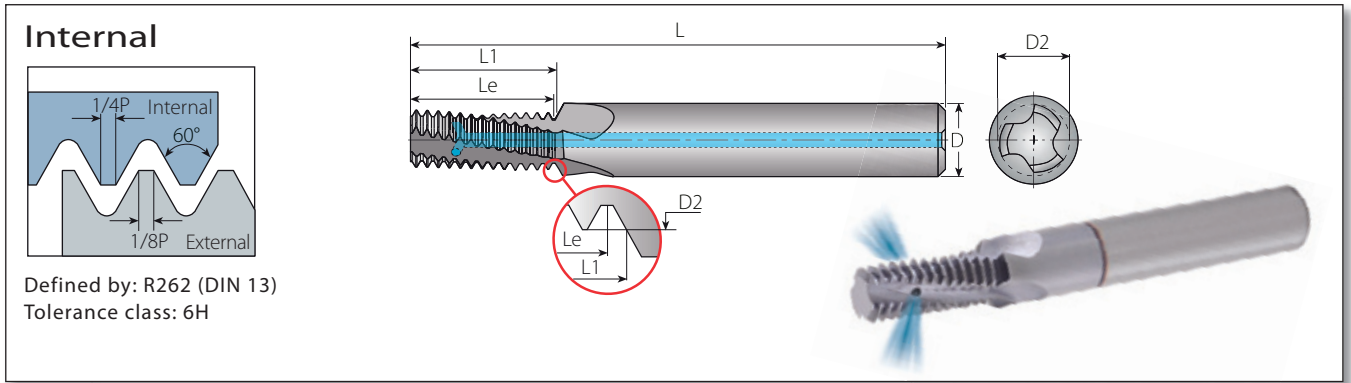

Defined by: R262 (DIN 13)  
Tolerance class: 6H

## HeliCool-R (HCR)

Helical Flutes with Radial Cooling

2 x Do (L1 ≤ 2 x Thread Diameter)

Thread		Pitch	Ordering Code	Dimensions [mm]					Flutes	Teeth	Bore Dia.*
M Coarse	M Fine	mm	Internal	D	D2	L	Le	L1	Z	Zt	mm
M6x1.0	M8-M40x1.0	1.0	HCR06048L12-I1.00ISO TM...	6	4.8	57	12.0	12.5	3	12	5.0
	M10x1.0	1.0	HCR10087L20-I1.00ISO TM...	10	8.7	73	20.0	20.5	3	20	9.0
	M12x1.0	1.0	HCR12107L24-I1.00ISO TM...	12	10.7	73	24.0	24.5	4	24	11.0
M8x1.25		1.25	HCR08065L16-I1.25ISO TM...	8	6.5	64	16.3	16.9	3	13	6.8
M10x1.5	M12-M48x1.5	1.5	HCR10082L20-I1.50ISO TM...	10	8.2	73	19.5	20.3	3	13	8.5
	M12x1.5	1.5	HCR10099L24-I1.50ISO TM...	10	9.9	73	24.0	24.8	4	16	10.5
	M14x1.5	1.5	HCR12119L29-I1.50ISO TM...	12	11.9	84	28.5	29.3	4	19	12.5
	M16x1.5	1.5	HCR14139L32-I1.50ISO TM...	14	13.9	84	31.5	32.3	4	21	14.5
M12x1.75		1.75	HCR10099L25-I1.75ISO TM...	10	9.9	73	24.5	25.4	4	14	10.2

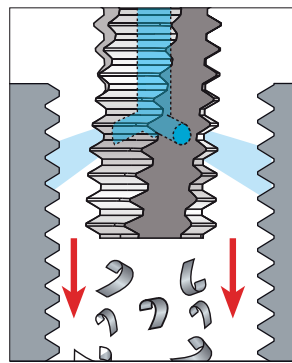

Helicool-R for Improved Chip Evacuation for Thru-Holes

\*Bore Diameter applies to smallest thread Dia.

Maximum thread length =  $L1 - \frac{\text{Pitch}}{4}$

# ISO Metric

# Helicool-C (HCC)

## Internal

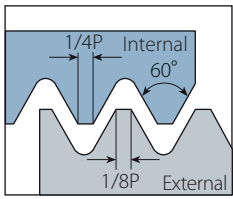

Defined by: R262 (DIN 13)  
Tolerance class: 6H

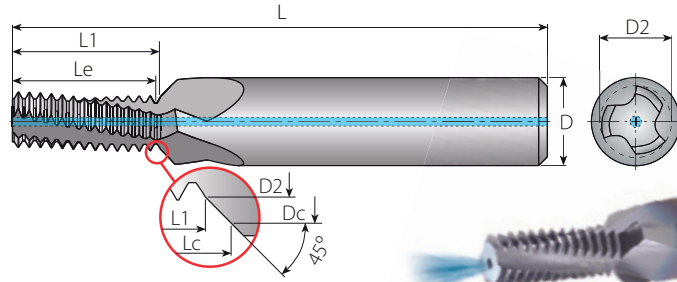

Dc = Minimum recommended chamfer diameter

## HeliCool-C (HCC)

### Helical Flutes with Axial Coolant - Thru & Chamfer

$2 \times D_o$  ( $L1 \leq 2 \times$  Thread Diameter)

Thread		Pitch	Ordering Code	Dimensions [mm]							No. of Flutes	Teeth	Bore Dia.*
M Coarse	M Fine	mm	Internal	D	D2	Dc	L	Le	L1	Lc	Z	Zt	mm
M6x1.0	M8-M40x1.0	1.0	HCC08048L12-I1.00ISO TM...	8	4.8	6.3	61	12.0	12.5	13.3	3	12	5.0
	M10x1.0	1.0	HCC12087L20-I1.00ISO TM...	12	8.7	10.3	73	20.0	20.5	21.3	3	20	9.0
	M12x1.0	1.0	HCC14107L24-I1.00ISO TM...	14	10.7	12.3	80	24.0	24.5	25.3	4	24	11.0
M8x1.25		1.25	HCC10065L16-I1.25ISO TM...	10	6.5	8.3	73	16.3	16.9	17.8	3	13	6.8
M10x1.5	M12-M48x1.5	1.5	HCC12082L20-I1.50ISO TM...	12	8.2	10.3	80	19.5	20.3	21.3	3	13	8.5
	M12x1.5	1.5	HCC14099L24-I1.50ISO TM...	14	9.9	12.3	80	24.0	24.8	26.0	4	16	10.5
	M14x1.5	1.5	HCC16119L29-I1.50ISO TM...	16	11.9	14.3	92	28.5	29.3	30.5	4	19	12.5
	M16x1.5	1.5	HCC18139L32-I1.50ISO TM...	18	13.9	16.3	92	31.5	32.3	33.5	4	21	14.5
M12x1.75		1.75	HCC14099L25-I1.75ISO TM...	14	9.9	12.3	80	24.5	25.4	26.6	4	14	10.2

## Helicool-C Operating Cycle

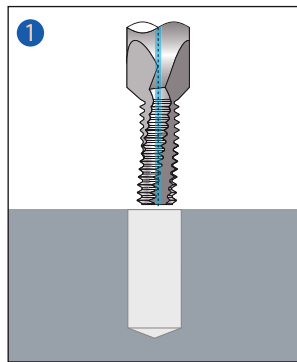

Positioning

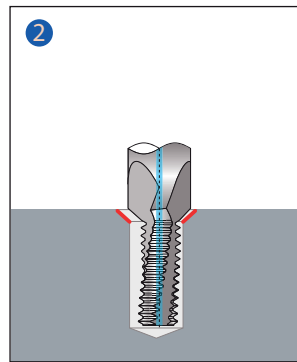

Chamfering

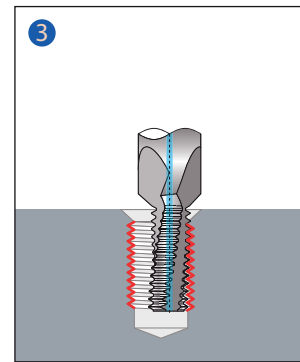

Thread Milling

## ISO Metric

## HTC (Thriller)

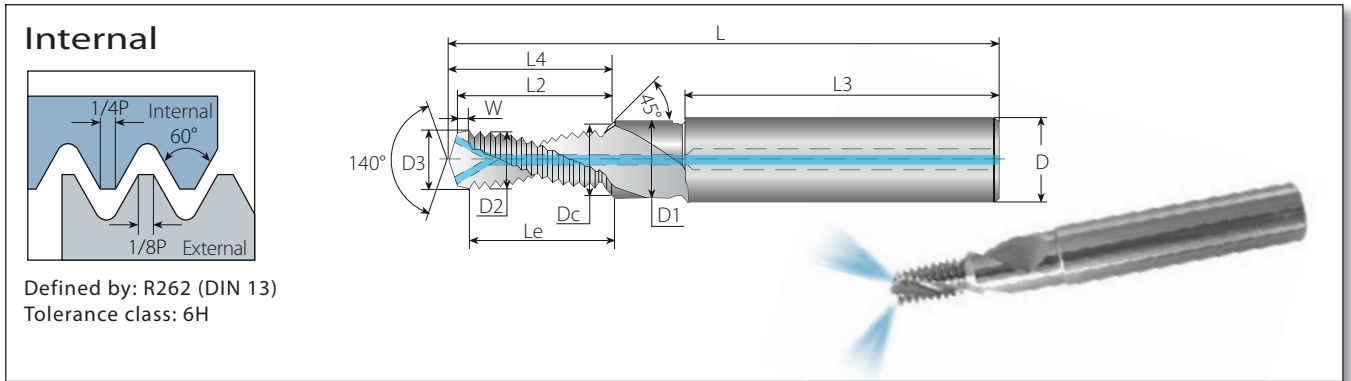

## HTC (Thriller)

Drill, Chamfer & Thread with Coolant-Thru

Thread	Ordering Code	Pitch	Dimensions											No. of Flutes		
			mm	L	L4	L2	L3	W	Le	D3	D	D1	Dc	D2	Z	Zt
<b>ISO 2xD0 Coarse</b>																
M6x1.0	HTC M6x1.0x2D...	1.00	62.0	14.5	13.7	36	1.0	12.7	5.0	8	6.6	6.3	4.85	2	11	
M8x1.25	HTC M8x1.25x2D ...	1.25	74.0	18.2	17.1	40	1.3	15.8	6.8	10	9.0	8.3	6.45	2	11	
M10x1.5	HTC M10x1.5x2D ...	1.50	79.0	23.4	22.1	45	1.5	20.6	8.5	12	11.0	10.3	8.08	2	12	
M12x1.75	HTC M12x1.75x2D...	1.75	89.0	27.1	25.5	45	1.5	24.0	10.3	14	13.5	12.3	9.74	2	12	
<b>ISO 2.5xD0 Coarse</b>																
M6x1.0	HTC M6x1.0x2.5D ...	1.00	62.0	16.5	15.7	36	1.0	14.7	5.0	8	6.6	6.3	4.85	2	13	
M8x1.25	HTC M8x1.25x2.5D...	1.25	74.0	23.2	22.1	40	1.3	20.8	6.8	10	9.0	8.3	6.45	2	15	
M10x1.5	HTC M10x1.5x2.5D...	1.50	79.0	27.9	26.6	45	1.5	25.1	8.5	12	11.0	10.3	8.08	2	15	

## HTC - Thriller Operating Cycle

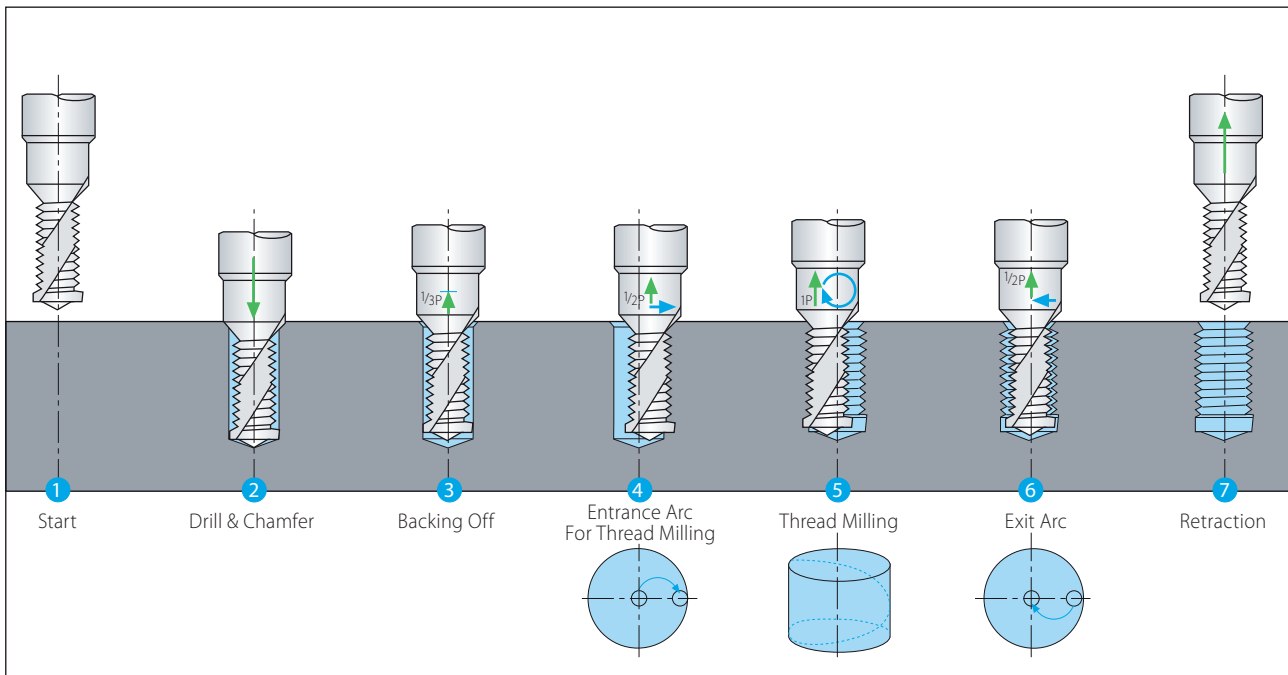

External / Internal

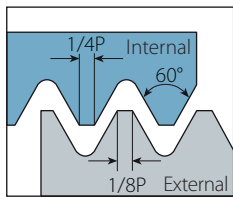

Defined by: R262 (DIN 13)  
Tolerance class: 6g/6H

Helical Flutes - External

2 x Do (L1 ≤ 2 x Thread Diameter)

Thread	Pitch	Ordering Code	Dimensions mm				No. of Flutes	Teeth
M Coarse	mm	External	D	D2	L	Le	Z	Zt
M3x0.5	0.5	H04039L06-E0.5ISO TM...	4	3.9	45	6.0	3	12
M4.5x0.75	0.75	H04039L09-E0.75ISO TM...	4	3.9	45	9.0	3	12
M6x1.0	1.0	H04039L12-E1.0ISO TM...	4	3.9	45	12.0	3	12
M8x1.25	1.25	H06059L16-E1.25ISO TM...	6	5.9	57	16.25	3	13
M10x1.5	1.5	H08079L21-E1.5ISO TM...	8	7.9	63	21.0	3	14
M14x2.0	2.0	H10099L28-E2.0ISO TM...	10	9.9	73	28.0	4	14

Helical Flutes - Internal

2 x Do (L1 ≤ 2 x Thread Diameter)

Thread	Pitch	Ordering Code	Dimensions mm				No. of Flutes	Teeth	Bore Dia.*
M Coarse	M Fine	Internal	D	D2	L	Le	Z	Zt	mm
M3x0.5	M3.5-M16x0.5	H04022L06-I0.5ISO TM...	4	2.2	45	6.0	3	12	2.5
	M4x0.5	H04030L08-I0.5ISO TM...	4	3.0	45	8.0	3	16	3.5
	M5x0.5	H04039L10-I0.5ISO TM...	4	3.9	45	10.0	3	20	4.5
M4x0.7		H04028L08-I0.7ISO TM...	4	2.8	45	8.4	3	12	3.3
	M6x0.75	H04039L12-I0.75ISO TM...	4	3.9	45	12.0	3	16	5.3
M5x0.8		H04035L10-I0.8ISO TM...	4	3.5	45	10.4	3	13	4.2
M6x1.0	M8-M40x1.0	H04039L12-I1.0ISO TM...	4	3.9	45	12.0	3	12	5.0
	M8x1.0	H06059L16-I1.0ISO TM...	6	5.9	57	16.0	3	16	7.0
	M10x1.0	H08079L20-I1.0ISO TM...	8	7.9	63	20.0	3	20	9.0
	M12x1.0	H10099L24-I1.0ISO TM...	10	9.9	73	24.0	4	24	11.0
M8x1.25		H06058L16-I1.25ISO TM...	6	5.8	57	16.25	3	13	6.8
	M10x1.25	H08077L20-I1.25ISO TM...	8	7.7	63	20.0	3	16	8.8
M10x1.5	M12-M48x1.5	H08077L21-I1.5ISO TM...	8	7.7	63	21.0	3	14	8.5
	M12x1.5	H10094L24-I1.5ISO TM...	10	9.4	73	24.0	4	16	10.5
	M14x1.5	H12112L28-I1.5ISO TM...	12	11.2	83	28.5	4	19	12.5
	M16x1.5	H12119L33-I1.5ISO TM...	12	11.9	83	33.0	4	22	14.5
M12x1.75		H10087L24-I1.75ISO TM...	10	8.7	73	24.5	4	14	10.2
M14x2.0	M17-M80x2.0	H10099L28-I2.0ISO TM...	10	9.9	73	28.0	4	14	12.0
M16x2.0	M17-M80x2.0	H12119L32-I2.0ISO TM...	12	11.9	83	32.0	4	16	14.0
M18-M22x2.5		H16139L40-I2.5ISO TM...	16	13.9	92	40.0	5	16	15.5
M24x3.0		H16159L42-I3.0ISO TM...	16	15.9	92	42.0	4	14	21.0

## External / Internal

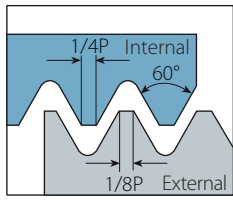

Defined by: ANSI B1.1.74  
Tolerance class: 2A/2B



## Helical Flutes - External

2 x Do (L1 ≤ 2 x Thread Diameter)

Thread		Pitch	Ordering Code	Dimensions mm				No. of Flutes	Teeth
UNC	UNF	tpi	External	D	D2	L	Le	Z	Zt
No.8-32		32	H04039L09-E32UNC TM...	4	3.9	45	8.7	3	11
	No.12-28	28	H04039L12-E28UNF TM...	4	3.9	45	11.8	3	13
No.12-24		24	H04039L12-E24UNC TM...	4	3.9	45	11.6	3	11
1/4"x20		20	H04039L13-E20UNC TM...	4	3.9	45	12.7	3	10
5/16"x18		18	H06059L17-E18UNC TM...	6	5.9	57	16.9	3	12
3/8"x16		16	H08079L19-E16UNC TM...	8	7.9	63	19.1	3	12
9/16"x12		12	H12119L30-E12UNC TM...	12	11.9	83	29.6	4	14

## Helical Flutes - Internal

2 x Do (L1 ≤ 2 x Thread Diameter)

Thread			Pitch	Ordering Code	Dimensions mm				No. of Flutes	Teeth	Bore Dia.*
UNC	UNF	UNEF	tpi	Internal	D	D2	L	Le	Z	Zt	mm
	No.8-36		36	H04030L09-I36UNF TM...	4	3.0	45	8.5	3	12	3.5
	No.10-32	No.12-3/8"x32	32	H04033L11-I32UNF TM...	4	3.3	45	11.1	3	14	4.0
	No.12-28, 1/4"x28	7/16", 1/2"x28	28	H04038L12-I28UNF TM...	4	3.8	45	11.8	3	13	4.6
	1/4"x28	7/16", 1/2"x28	28	H06046L13-I28UNF TM...	6	4.6	57	12.7	3	14	5.5
		7/16", 1/2"x28	28	H10092L23-I28UNEF TM...	10	9.2	73	22.7	4	25	10.2
No.10-24	5/16", 3/8"x24	9/16"-11/16"x24	24	H04029L11-I24UNC TM...	4	2.9	45	10.6	3	10	3.8
No.12-24	5/16", 3/8"x24	9/16"-11/16"x24	24	H04035L12-I24UNC TM...	4	3.5	45	11.6	3	11	4.5
	5/16", 3/8"x24	9/16"-11/16"x24	24	H06057L16-I24UNF TM...	6	5.7	57	15.9	3	15	6.8
	3/8"x24	9/16"-11/16"x24	24	H08074L19-I24UNF TM...	8	7.4	63	19.1	3	18	8.5
		9/16"-11/16"x24	24	H12119L29-I24UNEF TM...	12	11.9	83	28.6	4	27	13.2
1/4"x20	7/16", 1/2"x20	3/4"-1"x20	20	H04039L13-I20UNC TM...	4	3.9	45	12.7	3	10	5.2
	7/16", 1/2"x20	3/4"-1"x20	20	H10085L23-I20UNF TM...	10	8.5	73	22.9	4	18	9.8
	1/2"x20	3/4"-1"x20	20	H10099L26-I20UNF TM...	10	9.9	73	25.4	4	20	11.5
		3/4"-1"x20	20	H16159L38-I20UNEF TM...	16	15.9	92	38.1	5	30	17.8
5/16"x18	9/16", 5/8"x18	11/16"-1 1/16"x18	18	H06052L17-I18UNC TM...	6	5.2	57	16.9	3	12	6.5
	9/16", 5/8"x18	11/16"-1 1/16"x18	18	H12113L30-I18UNF TM...	12	11.3	83	29.6	4	21	12.8
	5/8"x18	11/16"-1 1/16"x18	18	H12119L33-I18UNF TM...	12	11.9	83	32.5	4	23	14.5
3/8"x16	3/4"x16		16	H08067L19-I16UNC TM...	8	6.7	63	19.1	3	12	8.0
	3/4"x16		16	H16159L38-I16UNF TM...	16	15.9	92	38.1	4	24	17.5
7/16"x14	7/8"x14		14	H08076L24-I14UNC TM...	8	7.6	63	23.6	4	13	9.3
	7/8"x14		14	H20187L44-I14UNF TM...	20	18.7	104	44.4	4	24	20.5
1/2"x13			13	H10089L26-I13UNC TM...	10	8.9	73	25.4	4	13	10.8
9/16"x12	1"-1 1/2"x12		12	H12103L30-I12UNC TM...	12	10.3	83	29.6	4	14	12.3
	1"-1 1/2"x12		12	H20199L51-I12UNF TM...	20	19.9	104	50.8	5	24	23.5
5/8"x11			11	H12110L32-I11UNC TM...	12	11.0	83	32.3	4	14	13.5
3/4"x10			10	H16135L38-I10UNC TM...	16	13.5	92	38.1	5	15	16.5
7/8"x9			9	H16152L45-I9UNC TM...	16	15.2	92	45.2	4	16	19.5
1"x8			8	H20170L51-I8UNC TM...	20	17.0	104	50.8	4	16	22.0

\*Bore Diameter applies to smallest thread Dia.

# BSP (G)

# Helical

## External / Internal

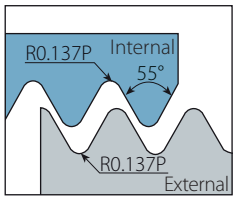

Defined by: B.S.2779:1956  
Tolerance class: Medium class

## Helical Flutes

2 x Do (L1 ≤ 2 x Thread Diameter)

Thread	Pitch	Ordering Code	Dimensions mm				No. of Flutes	Teeth	Bore Dia.*
Standard	tpi	External / Internal	D	D2	L	Le	Z	Zt	mm
1/16"x28, 1/8"x28	28	H06058L16-EI28BSP TM...	6	5.8	57	16.3	3	18	6.7
1/8"x28	28	H08077L20-EI28BSP TM...	8	7.7	63	20.0	3	22	8.7
1/4"x19, 3/8"x19	19	H10099L27-EI19BSP TM...	10	9.9	73	26.7	4	20	11.8
3/8"x19	19	H16134L33-EI19BSP TM...	16	13.4	92	33.4	4	25	15.2
1/2", 3/4"x14	14	H16157L44-EI14BSP TM...	16	15.7	92	43.5	5	24	19.0
1", 1 1/2", 2", 2 1/2"x11	11	H20199L42-EI11BSP TM...	20	19.9	104	41.6	5	18	30.7

# BSPT

# Helical

## External / Internal

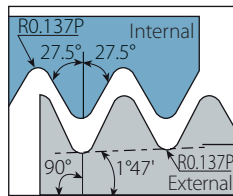

Defined by: B.S.21:1985  
Tolerance class: Standard BSPT

## Helical Flutes

Thread	Pitch	Ordering Code	Dimensions mm				No. of Flutes	Teeth	Bore Dia.*
Standard	tpi	External / Internal	D	D2	L	Le	Z	Zt	mm
1/16"x28	28	H06058L16-EI28BSPT TM...	6	5.8	57	16.3	3	18	6.7
1/8"x28	28	H08077L20-EI28BSPT TM...	8	7.7	63	20.0	3	22	8.7
1/4"x19	19	H10099L27-EI19BSPT TM...	10	9.9	73	26.7	4	20	11.8
3/8"x19	19	H16134L33-EI19BSPT TM...	16	13.4	92	33.4	4	25	15.2
1/2", 3/4"x14	14	H16157L44-EI14BSPT TM...	16	15.7	92	43.5	5	24	19.0
1", 1 1/2", 2", 2 1/2"x11	11	H20199L42-EI11BSPT TM...	20	19.9	104	41.6	5	18	30.7



# NPT

# Helical

## External / Internal

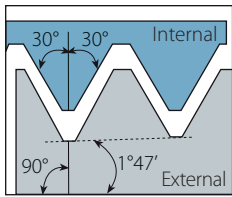

Defined by: USAS B2.1:1968  
Tolerance class: Standard NPT

## Helical Flutes

Thread	Pitch	Ordering Code	Dimensions mm				No. of Flutes	Teeth	Bore Dia.*
Standard	tpi	External / Internal	D	D2	L	Le	Z	Zt	mm
1/16"x27	27	H06053L09-EI27NPT TM...	6	5.3	57	9.4	3	10	6.3
1/8"x27	27	H08075L09-EI27NPT TM...	8	7.5	63	9.4	4	10	8.5
1/4"x18	18	H10094L14-EI18NPT TM...	10	9.4	73	14.1	4	10	11.1
3/8"x18	18	H12119L14-EI18NPT TM...	12	11.9	83	14.1	4	10	14.5
1/2", 3/4"x14	14	H16155L25-EI14NPT TM...	16	15.5	92	25.4	5	14	17.7, 23.0
1"-2"x11.5	11.5	H20199L33-EI11.5NPT TM...	20	19.9	104	33.1	5	15	29.0-56.0
2 1/2", 3"x8	8	H20199L38-EI8NPT TM...	20	19.9	104	38.1	4	12	66.5

# NPTF

# Helical

## External / Internal

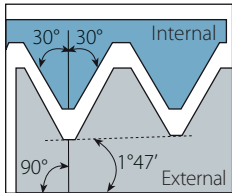

Defined by: ANSI 1.20.3-1976  
Tolerance class: Standard NPTF

## Helical Flutes

Thread	Pitch	Ordering Code	Dimensions mm				No. of Flutes	Teeth	Bore Dia.*
Standard	tpi	External / Internal	D	D2	L	Le	Z	Zt	mm
1/16"x27	27	H06053L09-EI27NPTF TM...	6	5.3	57	9.4	3	10	6.3
1/8"x27	27	H08075L09-EI27NPTF TM...	8	7.5	63	9.4	4	10	8.4
1/4"x18	18	H10094L14-EI18NPTF TM...	10	9.4	73	14.1	4	10	11.1
3/8"x18	18	H12119L14-EI18NPTF TM...	12	11.9	83	14.1	4	10	14.7
1/2", 3/4"x14	14	H16155L25-EI14NPTF TM...	16	15.5	92	25.4	5	14	17.9, 23.4
1"-2"x11.5	11.5	H20199L33-EI11.5NPTF TM...	20	19.9	104	33.1	5	15	29.4-56.2
2 1/2", 3"x8	8	H20199L38-EI8NPTF TM...	20	19.9	104	38.1	4	12	67.0

\*Bore Diameter applies to smallest thread Dia.

# ISO Metric

# Deep Threading

## Internal

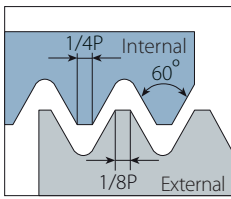

Defined by: R262 (DIN 13)  
Tolerance class: 6H

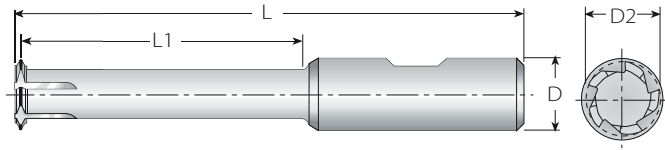

## Deep Threading - Long Tools for Deep Holes

3 x Do (L1 ≤ 3 x Thread Diameter)

Thread	Pitch	Ordering Code	Dimensions mm				No. of Flutes	Teeth	Bore Dia.
M Coarse	mm	Internal	D	D2	L	L1	Z	Zt	mm
M6x1	1.0	D1T08041-I1.0ISO TM...	8	4.1	63	19	3	1	5.0
M8x1.25	1.25	D1T10058-I1.25ISO TM...	10	5.8	73	26	3	1	6.8
M10x1.5	1.50	D1T10077-I1.50ISO TM...	10	7.7	73	32	3	1	8.5
M12x1.5	1.50	D1T12094-I1.50ISO TM...	12	9.4	83	38	4	1	10.5
M12x1.75	1.75	D1T12087-I1.75ISO TM...	12	8.7	83	38	4	1	10.2
M14x2	2.0	D1T16102-I2.0ISO TM...	16	10.2	92	44	4	1	12.0
M16x2	2.0	D1T16122-I2.0ISO TM...	16	12.2	100	50	4	1	14.0
M18x2.5	2.50	D1T16129-I2.5ISO TM...	16	12.9	108	57	5	1	15.5
M20x2.5	2.50	D1T16148-I2.5ISO TM...	16	14.8	114	63	5	1	17.5

## Partial Profile 60°

## Deep Threading

### Internal

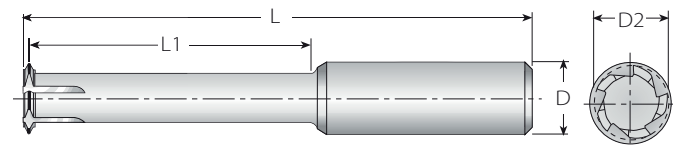
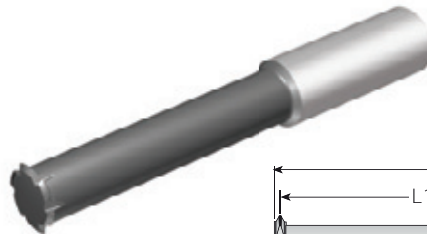
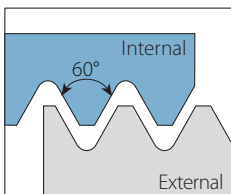

## Deep Threading - Long Tools for Deep Holes

Min. Thread		Pitch	Ordering Code		Dimensions						
M coarse	M fine	UN, UNS, UNF, UNEF	mm	tpi	Internal	D	D2	L	L1	Z	Zt
M5x0.8	M5x0.5, M5x0.75	No.10-56UNS, No.10-48UNS, No.10-40UNS, No.10-36UNS, No.10-32UNF	0.5-0.8	32-56	D1T04390L160-ITA60 TM...	4	3.90	45	16	4	1
M6x1.0	M6x0.5, M6x0.75	No.12-56UNS, No.12-48UNS, 1/4-40UNS, 1/4-36UNS, 1/4-32UNEF, 1/4-28UNF, 1/4-27UNS, 1/4-24UNS	0.5-1.0	24-56	D1T06485L200-ITB60 TM...	6	4.85	51	20	5	1
M8x1.25	M7x0.5, M7x0.75, M7.5x1.0	5/16-48UNS, 5/16-40UNS, 5/16-36UNS, 5/16-32UNEF, 5/16-28UN, 5/16-27UNS, 5/16-24UNS, 5/16-20UN	0.5-1.25	20-48	D1T06590L250-ITF60 TM...	6	5.90	64	25	5	1
-	M10.5x0.5, M11x0.75, M11x1.0	7/16-32UN, 7/16-28UNEF, 7/16-27UNS, 7/16-24UNS	0.5-1.0	24-56	D1T10990L350-ITB60 TM...	10	9.90	73	35	6	1
M10x1.5	M10x1.0, M10x1.25	3/8-24UNF, 3/8-20UN, 7/16-18UNS, 7/16-16UN	1.0-1.50	16-24	D1T08790L320-ITC60 TM...	8	7.90	63	32	6	1
M12x1.75	M12x1.0, M12x1.25, M12x1.5	1/2-24UNS, 1/2-20UNS, 1/2-18UNS, 1/2-16UNS, 1/2-14UNS	1.0-1.75	14-24	D1T10990L380-ITD60 TM...	10	9.90	73	38	6	1
-	M13.5x1.0, M14x1.25, M14x1.5	5/8-24UNEF	1.0-1.75	14-24	D1T12119L450-ITD60 TM...	12	11.90	83	45	6	1

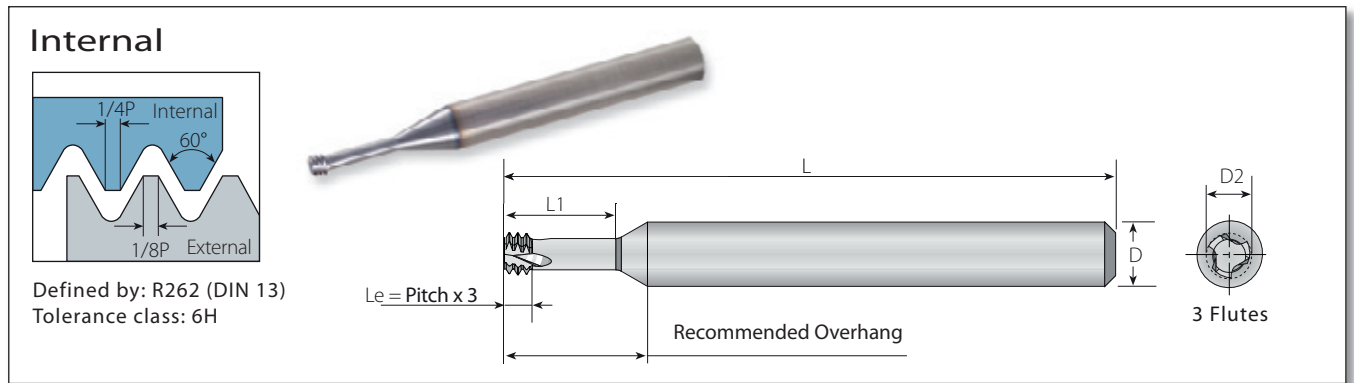

**MilliPro**

Miniature Thread Mills

2 x Do (L1 ≤ 2 x Thread Diameter)

Thread		Pitch	Ordering Code	Dimensions mm				No. of Flutes	Teeth	Bore Dia.*
M Coarse	M Fine	mm	Internal	D	D2	L	L1	Z	Zt	mm
M1.6x0.35		0.35	D3T03012L034-I0.35ISO TM...	3	1.20	30	3.4	3	3	1.25
M2x0.4		0.4	D3T06015L042-I0.4ISO TM...	6	1.55	57	4.2	3	3	1.6
M2.2x0.45		0.45	D3T06016L046-I0.45ISO TM...	6	1.65	57	4.6	3	3	1.75
M2.5x0.45		0.45	D3T06019L052-I0.45ISO TM...	6	1.95	57	5.2	3	3	2.05
M3x0.5	M3.5-M16x0.5	0.5	D3T06024L062-I0.5ISO TM...	6	2.40	57	6.2	3	3	2.5
M3.5x0.6		0.6	D3T06027L073-I0.6ISO TM...	6	2.75	57	7.3	3	3	2.9
M4x0.7		0.7	D3T06031L083-I0.7ISO TM...	6	3.15	57	8.3	3	3	3.3
M5x0.8		0.8	D3T06040L104-I0.8ISO TM...	6	4.05	57	10.4	3	3	4.2
M6x1.0	M8-M40x1.0	1.0	D3T06048L125-I1.0ISO TM...	6	4.80	57	12.5	3	3	5.0
M8x1.25		1.25	D3T08065L166-I1.25ISO TM...	8	6.50	63	16.6	3	3	6.8
M10x1.5	M12-M48x1.50	1.50	D3T10082L208-I1.50ISO TM...	10	8.20	73	20.8	3	3	8.5
M12x1.75		1.75	D3T10099L250-I1.75ISO TM...	10	9.90	73	25.0	3	3	10.3
M16x2.0		2.0	D3T12119L330-I2.0ISO TM...	12	11.90	83	33.0	3	3	14.0
M20x2.5		2.50	D3T16159L413-I2.5ISO TM...	16	15.90	92	41.3	3	3	17.5

**MilliPro**

Miniature Thread Mills

3 x Do (L1 ≤ 3 x Thread Diameter)

Thread		Pitch	Ordering Code	Dimensions mm				No. of Flutes	Teeth	Bore Dia.*
M Coarse	M Fine	mm	Internal	D	D2	L	L1	Z	Zt	mm
M1.6x0.35		0.35	D3T03012L050-I0.35ISO TM...	3	1.20	30	5.0	3	3	1.25
M2x0.4		0.4	D3T03015L062-I0.4ISO TM...	3	1.55	30	6.2	3	3	1.6
M2x0.4		0.4	D3T06015L062-I0.4ISO TM...	6	1.55	57	6.2	3	3	1.6
M2.5x0.45		0.45	D3T03019L077-I0.45ISO TM...	3	1.95	30	7.7	3	3	2.05
M2.5x0.45		0.45	D3T06019L077-I0.45ISO TM...	6	1.95	57	7.7	3	3	2.05
M3x0.5	M3.5-M16x0.5	0.5	D3T03024L092-I0.5ISO TM...	3	2.40	30	9.2	3	3	2.5
M3x0.5	M3.5-M16x0.5	0.5	D3T06024L092-I0.5ISO TM...	6	2.40	57	9.2	3	3	2.5
M4x0.7		0.7	D3T06031L123-I0.7ISO TM...	6	3.15	57	12.3	3	3	3.3
M5x0.8		0.8	D3T06040L154-I0.8ISO TM...	6	4.05	57	15.4	3	3	4.2
M6x1.0	M8-M40x1.0	1.00	D3T06048L185-I1.0ISO TM...	6	4.80	57	18.5	3	3	5.0
M8x1.25		1.25	D3T08065L246-I1.25ISO TM...	8	6.50	63	24.6	3	3	6.8

\*Bore Diameter applies to smallest thread Dia.

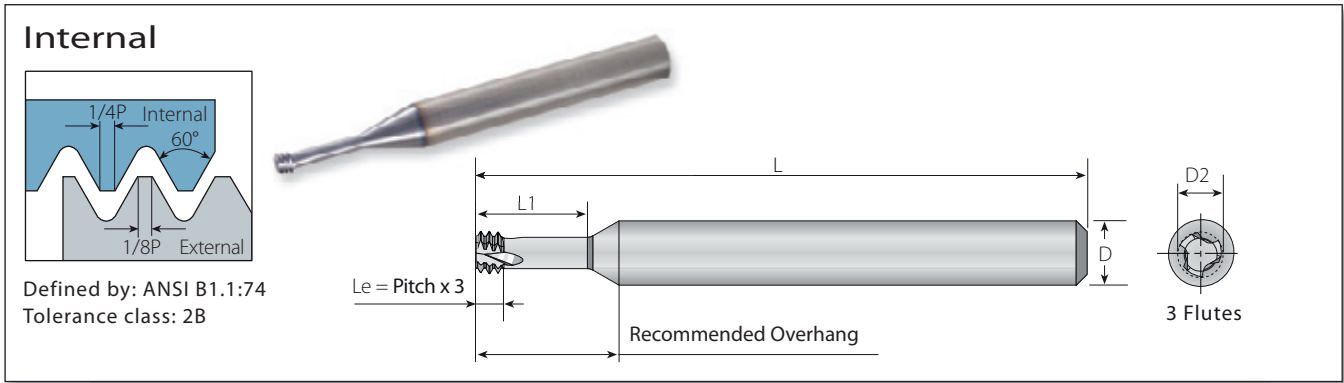

MilliPro

Miniature Thread Mills

2 x Do (L1 ≤ 2 x Thread Diameter)

Thread		Pitch	Ordering Code	Dimensions mm				No. of Flutes	Teeth	Bore Dia.*
UNC	UNF	tpi	Internal	D	D2	L	L1	Z	Zt	mm
	No.1-72	72	D3T06014L039-I72UN TM...	6	1.45	57	3.9	3	3	1.6
No.1-64	No.2-64	64	D3T06014L042-I64UN TM...	6	1.40	57	4.2	3	3	1.5
No.2-56	No.3-56	56	D3T06016L050-I56UN TM...	6	1.65	57	5.0	3	3	1.8
No.3-48	No.4-48	48	D3T06019L060-I48UN TM...	6	1.90	57	6.0	3	3	2.1
No.4, No.5-40	No.6-40	40	D3T06021L060-I40UN TM...	6	2.10	57	6.0	3	3	2.3
No.5-40	No.6-40	40	D3T06024L072-I40UN TM...	6	2.45	57	7.2	3	3	2.6
	No.8-36	36	D3T06033L087-I36UN TM...	6	3.30	57	8.7	3	3	3.5
No.6, No.8-32	No.10-32	32	D3T06025L074-I32UN TM...	6	2.55	57	7.4	3	3	2.8
No.8-32	No.10-32	32	D3T06032L100-I32UN TM...	6	3.20	57	10.0	3	3	3.5
	1/4"x28	28	D3T06052L132-I28UN TM...	6	5.25	57	13.2	3	3	5.5
No.10-24	5/16"x24	24	D3T06035L102-I24UN TM...	6	3.58	57	10.2	3	3	3.9
	5/16"x24	24	D3T08066L165-I24UN TM...	8	6.68	63	16.5	3	3	6.9
1/4"x20	7/16"x20	20	D3T06048L134-I20UN TM...	6	4.88	57	13.4	3	3	5.2
	7/16"x20	20	D3T10095L230-I20UN TM...	10	9.55	73	23.0	3	3	9.9
3/8"x16		16	D3T08067L191-I16UN TM...	8	6.70	63	19.1	3	3	8.0
7/16"x14		14	D3T10090L233-I14UN TM...	10	9.00	73	23.3	3	3	9.4

MilliPro

Miniature Thread Mills

3 x Do (L1 ≤ 3 x Thread Diameter)

Thread		Pitch	Ordering Code	Dimensions mm				No. of Flutes	Teeth	Bore Dia.*
UNC	UNF	tpi	Internal	D	D2	L	L1	Z	Zt	mm
	No.1-72	72	D3T03014L057-I72UN TM...	3	1.45	30	5.75	3	3	1.6
	No.1-72	72	D3T06014L057-I72UN TM...	6	1.45	57	5.75	3	3	1.6
No.2-56	No.3-56	56	D3T03016L070-I56UN TM...	3	1.65	30	7.0	3	3	1.8
No.4, No.5-40	No.6-40	40	D3T03021L090-I40UN TM...	3	2.10	30	9.0	3	3	2.3
No.4, No.5-40	No.6-40	40	D3T06021L090-I40UN TM...	6	2.10	57	9.0	3	3	2.3
No.5-40	No.6-40	40	D3T06024L100-I40UN TM...	6	2.45	57	10.0	3	3	2.6
No.6, No.8-32	No.10-32	32	D3T03025L110-I32UN TM...	3	2.55	30	11.0	3	3	2.8
No.6, No.8-32	No.10-32	32	D3T06025L110-I32UN TM...	6	2.55	57	11.0	3	3	2.8
No.8-32	No.10-32	32	D3T06032L130-I32UN TM...	6	3.20	57	13.0	3	3	3.4
	1/4"x28	28	D3T06052L196-I28UN TM...	6	5.25	57	19.6	3	3	5.5
	5/16"x24	24	D3T08066L245-I24UN TM...	8	6.68	63	24.5	3	3	6.9
1/4"x20	7/16"x20	20	D3T06048L198-I20UN TM...	6	4.88	57	19.8	3	3	5.1

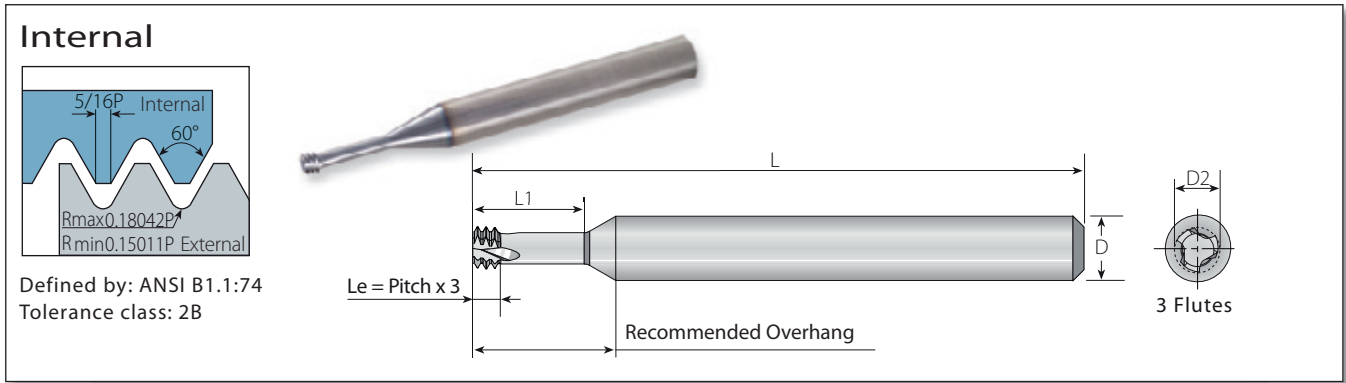

MilliPro - Miniature Thread Mills

3 x Do (L1 ≤ 3 x Thread Diameter)

Thread	Pitch	Ordering Code	Dimensions mm				No. of Flutes	Teeth	Bore Dia.*
UNJC	UNJF	Internal	D	D2	L	L1	Z	Zt	mm
0.138" (#6)	0.190" (#10)	D3T06027L110-I32UNJ TM...	6	2.70	57	11.0	3	3	2.8
	0.250" (1/4")	D3T06054L195-I28UNJ TM...	6	5.40	57	19.5	3	3	5.6
0.190" (#10)		D3T06037L149-I24UNJ TM...	6	3.70	57	14.9	3	3	4.0
	0.3125" (5/16")	D3T08067L241-I24UNJ TM...	8	6.70	63	24.1	3	3	7.0
0.250" (1/4")		D3T06050L195-I20UNJ TM...	6	5.00	57	19.5	3	3	5.3
	0.4375" (7/16")	D3T10096L335-I20UNJ TM...	10	9.60	73	33.5	3	3	10.0
0.3125" (5/16")	0.5625" (9/16")	D3T08064L241-I18UNJ TM...	8	6.40	63	24.1	3	3	6.75
0.375" (3/8")	0.750" (3/4")	D3T08077L290-I16UNJ TM...	8	7.70	63	29.0	3	3	8.1
0.4375" (7/16")	0.875" (7/8")	D3T10092L335-I14UNJ TM...	10	9.20	73	33.5	3	3	9.5
0.500" (1/2")		D3T10099L385-I13UNJ TM...	10	9.90	73	38.5	3	3	11.0

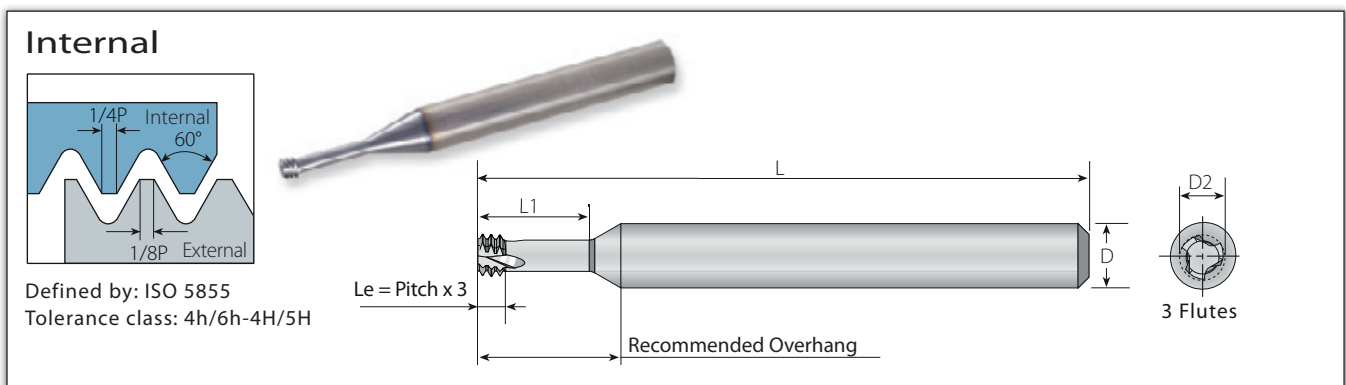

MilliPro - Miniature Thread Mills

3 x Do (L1 ≤ 3 x Thread Diameter)

Thread	Pitch	Ordering Code	Dimensions mm				No. of Flutes	Teeth	Bore Dia.
Standard	mm	Internal	D	D2	L	L1	Z	Zt	mm
MJ3x0.5	0.5	D3T06024L092-I0.5MJ TM...	6	2.40	57	9.2	3	3	2.6
MJ3.5x0.6	0.6	D3T06028L110-I0.6MJ TM...	6	2.85	57	11.0	3	3	3.0
MJ4x0.7	0.7	D3T06031L123-I0.7MJ TM...	6	3.15	57	12.3	3	3	3.4
MJ5x0.8	0.8	D3T06040L154-I0.8MJ TM...	6	4.05	57	15.4	3	3	4.3
MJ6x1.0	1.0	D3T06048L185-I1.0MJ TM...	6	4.80	57	18.5	3	3	5.1
MJ8x1.25	1.25	D3T08065L246-I1.25MJ TM...	8	6.50	63	24.6	3	3	6.9
MJ10x1.5	1.50	D3T10082L308-I1.50MJ TM...	10	8.20	73	30.8	3	3	8.7
MJ12x1.75	1.75	D3T10099L370-I1.75MJ TM...	10	9.90	73	37.0	3	3	10.4
MJ14x2	2.0	D3T12119L425-I2.0MJ TM...	12	11.90	83	42.5	3	3	12.25

\*Bore Diameter applies to smallest thread Dia.

## ISO Metric

## MilliPro Dental

### Internal

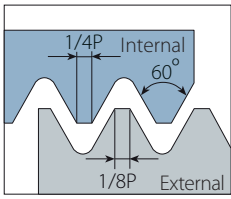

Defined by: R262 (DIN 13)  
Tolerance class: 6H

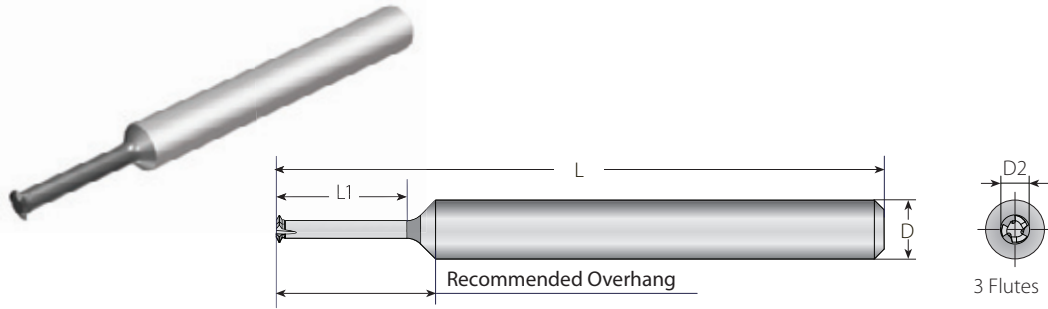

## MilliPro Dental

### Miniature Thread Mills for Dental Implants

3xDo (L1 ≤ 3 x Thread Diameter)

Thread		Pitch	Ordering Code	Dimensions mm			No. of Flutes	Teeth	Bore Dia.	
M Coarse	M Fine	mm	Internal	D	D2	L	L1	Z	Zt	mm
M1.0x0.25	M1.4x0.25	0.25	D1T03007L031-I0.25ISO TM...	3	0.70	31	3.1	3	1	0.75
M1.2x0.25	M1.4x0.25	0.25	D1T03009L038-I0.25ISO TM...	3	0.90	31	3.8	3	1	0.95
M1.4x0.3		0.30	D1T03011L044-I0.30ISO TM...	3	1.05	31	4.4	3	1	1.15
M1.6x0.35		0.35	D1T03012L050-I0.35ISO TM...	3	1.20	31	5.0	3	1	1.30
M1.8x0.35	M2.0x0.35	0.35	D1T03014L056-I0.35ISO TM...	3	1.40	31	5.6	3	1	1.50
M2.0x0.4		0.40	D1T03015L062-I0.40ISO TM...	3	1.50	31	6.2	3	1	1.65
M2.5x0.45		0.45	D1T03019L077-I0.45ISO TM...	3	1.95	31	7.7	3	1	2.10

## American UN

## MilliPro Dental

### Internal

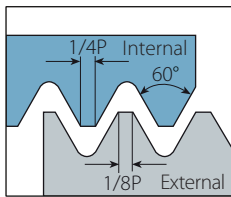

Defined by: ANSI B1.1:74  
Tolerance class: 2B

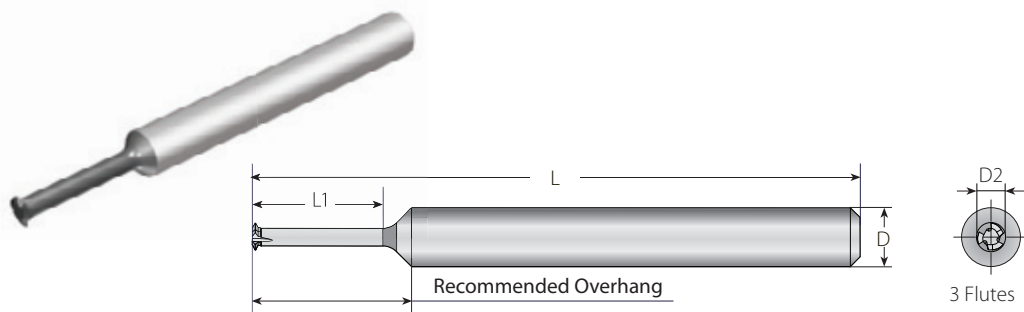

## MilliPro Dental

### Miniature Thread Mills for Dental Implants

3xDo (L1 ≤ 3 x Thread Diameter)

Thread		Pitch	Ordering Code	Dimensions mm			No. of Flutes	Teeth	Bore Dia.	
UNF		tpi	Internal	D	D2	L	L1	Z	Zt	mm
0-80		80	D1T03011L046-I80UN TM...	3	1.15	31	4.6	3	1	1.30
1-72		72	D1T03014L065-I72UN TM...	3	1.45	31	6.5	3	1	1.60

The MilliPro Dental line was specially designed for machining Titanium and Stainless Steel in high RPM.

MilliPro Dental D1T tools are also suitable for general use applications

# ISO Metric

# MilliPro EL

**Internal**

Defined by: R262 (DIN 13)  
Tolerance class: 6H

Le = Pitch x 3

Recommended Overhang

3 Flutes

## MilliPro EL

### Miniature Thread Mills, Extra Long Tools

2 x Do (L1 ≤ 2 x Thread Diameter)

Thread		Pitch	Ordering Code	Dimensions mm				No. of Flutes	Teeth	Bore Dia.*
M Coarse	M Fine	mm	Internal	D	D2	L	L1	Z	Zt	mm
M2x0.4		0.4	D3T06015L042-I0.4ISO TML...	6	1.55	100	4.2	3	3	1.6
M2.5x0.45		0.45	D3T06019L052-I0.45ISO TML...	6	1.95	100	5.2	3	3	2.05
M3x0.5	M3.5-M16x0.5	0.5	D3T06024L062-I0.5ISO TML...	6	2.40	100	6.2	3	3	2.5

# American UN

# MilliPro EL

**Internal**

Defined by: ANSI B1.1:74  
Tolerance class: 2B

Le = Pitch x 3

Recommended Overhang

3 Flutes

## MilliPro EL

### Miniature Thread Mills, Extra Long Tools

2 x Do (L1 ≤ 2 x Thread Diameter)

Thread		Pitch	Ordering Code	Dimensions mm				No. of Flutes	Teeth	Bore Dia.*
UNC	UNF	tpi	Internal	D	D2	L	L1	Z	Zt	mm
No.2-56	No.3-56	56	D3T06016L050-I56UN TML...	6	1.65	100	5.0	3	3	1.8
No.4, No.5-40	No.6-40	40	D3T06021L060-I40UN TML...	6	2.10	100	6.0	3	3	2.3
No.6, No.8-32	No.10-32	32	D3T06025L074-I32UN TML...	6	2.55	100	7.4	3	3	2.8
No.8-32	No.10-32	32	D3T06032L100-I32UN TML...	6	3.20	100	10.0	3	3	3.4

\*Bore Diameter applies to smallest thread Dia.

Internal

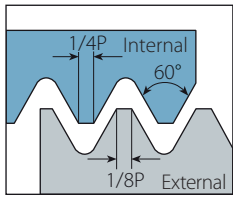

Defined by: R262 (DIN 13)  
Tolerance class: 6H

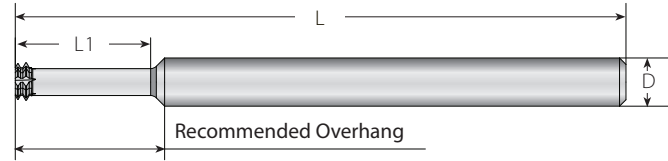

4-6 Flute:

Left Hand Tool

MilliPro HD

Miniature Thread Mills for Hard Materials Up to 62HRC

2 x Do (L1 ≤ 2 x Thread Diameter)

Thread		Pitch	Ordering Code	Dimensions mm				No. of Flutes	Teeth	Bore Dia.*
M Coarse	M Fine	mm	Internal	D	D2	L	L1	Z	Zt	mm
M2x0.4		0.4	S2L06015L042-I0.4ISO TM...	6	1.55	76	4.60	4	2	1.6
M2.2x0.45		0.45	S2L06016L046-I0.45ISO TM...	6	1.65	76	5.05	4	2	1.8
M2.5x0.45		0.45	S2L06019L052-I0.45ISO TM...	6	1.95	76	5.65	4	2	2.05
M3x0.5	M3.5-M16x0.5	0.5	S2L06024L062-I0.5ISO TM...	6	2.40	76	6.75	4	2	2.55
M3.5x0.6		0.6	S2L06027L073-I0.6ISO TM...	6	2.75	76	7.90	4	2	2.95
M4x0.7		0.7	S2L06031L083-I0.7ISO TM...	6	3.15	76	9.05	4	2	3.35
M5x0.8		0.8	S2L06040L104-I0.8ISO TM...	6	4.05	76	11.20	4	2	4.3
M6x1.0	M8x-M40x1.0	1.0	S2L06048L125-I1.0ISO TM...	6	4.80	76	13.50	5	2	5.1
M8x1.25		1.25	S2L08065L166-I1.25ISO TM...	8	6.50	80	17.85	5	2	6.8
M10x1.5	M12-M48x1.50	1.50	S2L08079L208-I1.50ISO TM...	8	7.90	80	22.30	6	2	8.6
M12x1.75		1.75	S2L10099L250-I1.75ISO TM...	10	9.90	101	26.75	6	2	10.4

MilliPro HD

Miniature Thread Mills for Hard Materials Up to 62HRC

3 x Do (L1 ≤ 3 x Thread Diameter)

Thread		Pitch	Ordering Code	Dimensions mm				No. of Flutes	Teeth	Bore Dia.*
M Coarse	M Fine	mm	Internal	D	D2	L	L1	Z	Zt	mm
M2x0.4		0.4	S2L06015L062-I0.4ISO TM...	6	1.55	76	6.60	4	2	1.6
M2.5x0.45		0.45	S2L06019L077-I0.45ISO TM...	6	1.95	76	8.15	4	2	2.05
M3x0.5	M3.5-M16x0.5	0.5	S2L06024L092-I0.5ISO TM...	6	2.40	76	9.75	4	2	2.55
M4x0.7		0.7	S2L06031L123-I0.7ISO TM...	6	3.15	76	13.05	4	2	3.35
M5x0.8		0.8	S2L06040L154-I0.8ISO TM...	6	4.05	76	16.20	4	2	4.3
M6x1.0	M8-M40x1.0	1.0	S2L06048L185-I1.0ISO TM...	6	4.80	76	19.50	5	2	5.1
M8x1.25		1.25	S2L08065L246-I1.25ISO TM...	8	6.50	80	25.85	5	2	6.8

MilliPro-HD

Two cutting teeth: Partial Profile for leading tooth followed by Full Profile for finishing.

The work direction should be from the top to the bottom (Climb Milling).

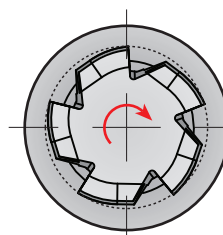
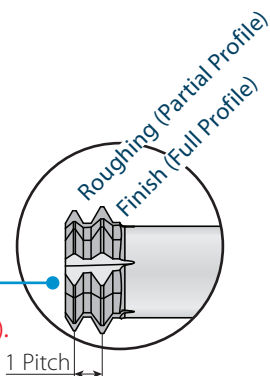

MilliPro HD Tools are left handed. For CNC use M04 code.



**Internal**

Defined by: ANSI B1.1:74  
Tolerance class: 2B

Recommended Overhang

4-6 Flute:

**Left Hand Tool**

**MilliPro HD**

Miniature Thread Mills for Hard Materials Up to 62HRC

2 x Do (L1 ≤ 2 x Thread Diameter)

Thread		Pitch	Ordering Code	Dimensions mm				No. of Flutes	Teeth	Bore Dia.*
UNC	UNF	tpi	Internal	D	D2	L	L1	Z	Zt	mm
No.2-56	No.3-56	56	S2L06016L050-I56UN TM...	6	1.65	76	5.45	4	2	1.80
No.3-48	No.4-48	48	S2L06019L060-I48UN TM...	6	1.90	76	6.53	4	2	2.10
No.4-40, No.5-40	No.6-40	40	S2L06021L060-I40UN TM...	6	2.10	76	6.64	4	2	2.35
No.5-40	No.6-40	40	S2L06024L072-I40UN TM...	6	2.45	76	7.84	4	2	2.65
	No.8-36	36	S2L06033L087-I36UN TM...	6	3.30	76	9.41	4	2	3.55
No.6-32, No.8-32	No.10-32	32	S2L06025L074-I32UN TM...	6	2.55	76	8.20	4	2	2.85
No.8-32	No.10-32	32	S2L06032L100-I32UN TM...	6	3.20	76	10.79	4	2	3.50
	No.10-32	32	S2L06037L100-I32UN TM...	6	3.70	76	10.80	4	2	4.17
	1/4"x28	28	S2L06052L132-I28UN TM...	6	5.25	76	14.11	5	2	5.55
No.10-24	5/16"x24	24	S2L06035L102-I24UN TM...	6	3.58	76	11.26	4	2	3.90
	5/16"x24	24	S2L08066L165-I24UN TM...	8	6.68	80	17.56	5	2	7.00
1/4"-20	7/16"x20	20	S2L06048L134-I20UN TM...	6	4.88	76	14.67	5	2	5.20
	7/16"x20	20	S2L10095L230-I20UN TM...	10	9.55	101	24.27	6	2	9.90
3/8"x16		16	S2L08076L197-I16UN TM...	8	7.65	80	21.29	5	2	8.00
7/16"x14		14	S2L10090L233-I14UN TM...	10	9.00	101	25.11	6	2	9.50
1/2"x13		13	S2L10099L256-I13UN TM...	10	9.90	101	27.55	6	2	10.90

**MilliPro HD**

Miniature Thread Mills for Hard Materials Up to 62HRC

3 x Do (L1 ≤ 3 x Thread Diameter)

Thread		Pitch	Ordering Code	Dimensions mm				No. of Flutes	Teeth	Bore Dia.*
UNC	UNF	tpi	Internal	D	D2	L	L1	Z	Zt	mm
No.4-40, No.5-40	No.6-40	40	S2L06021L090-I40UN TM...	6	2.10	76	9.64	4	2	2.35
No.5-40	No.6-40	40	S2L06024L100-I40UN TM...	6	2.45	76	10.64	4	2	2.65
No.6-32, No.8-32	No.10-32	32	S2L06025L110-I32UN TM...	6	2.55	76	11.79	4	2	2.85
No.8-32	No.10-32	32	S2L06032L130-I32UN TM...	6	3.20	76	13.79	4	2	3.50
	1/4"x28	28	S2L06052L196-I28UN TM...	6	5.25	76	20.51	5	2	5.55
	5/16"x24	24	S2L08066L245-I24UN TM...	8	6.68	80	25.56	5	2	7.00
1/4"x20	7/16"x20	20	S2L06048L198-I20UN TM...	6	4.88	76	21.07	5	2	5.20
7/16"x14		14	S2L10090L335-I14UN TM...	10	9.00	101	35.31	6	2	9.50

Roughing (Partial Profile)

Finish (Full Profile)

Two cutting teeth: Partial Profile for leading tooth followed by Full Profile for finishing.

The work direction should be from the top to the bottom (Climb Milling).

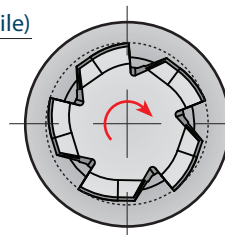
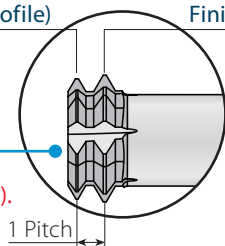

MilliPro HD Tools are left handed. For CNC use M04 code.

\*Bore Diameter applies to smallest thread Dia.

External / Internal

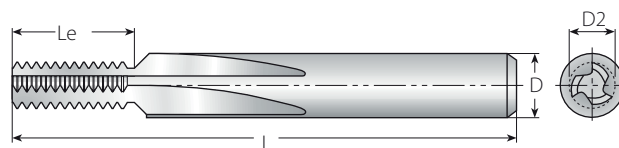
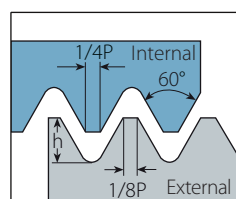

Defined by: R262 (DIN 13)  
Tolerance class: 6g/6H

Straight Flutes - External

Thread	Pitch	Ordering Code	Dimensions mm				No. of Flutes	Teeth	
Min. Dia.	mm	External	D	D2	L	Le	Z	Zt	h mm
M3	0.50	S06059-E0.5ISO TM...	6	5.90	57	15.0	3	30	0.31
M4.5	0.75	S08079-E0.75ISO TM...	8	7.90	63	19.5	3, 5 *	26	0.46
M6	1.00	S10099-E1.0ISO TM...	10	9.90	72	24.0	5	24	0.61
M10	1.50	S12119-E1.5ISO TM...	12	11.90	83	30.0	5	20	0.92
M14	2.00	S12119-E2.0ISO TM...	12	11.90	83	30.0	5	15	1.23
M24	3.00	S16159-E3.0ISO TM...	16	15.90	92	36.0	5	12	1.84
M36	4.00	S16159-E4.0ISO TM...	16	15.90	92	40.0	5	10	2.45
M64	6.00	S20199-E6.0ISO TM...	20	19.90	104	36.0	5	6	3.68

\* Available with 3 and 5 flutes. Add 3 or 5 to the ordering code (TM3.../TM5...)

Straight Flutes - Internal

Thread	Pitch	Ordering Code	Dimensions mm				No. of Flutes	Teeth	
Min. Dia.	mm	Internal	D	D2	L	Le	Z	Zt	h mm
M4.5	0.75	S04030-I0.75ISO TM...	4	3.00	42	6.7	3	9	0.43
M8	0.75	S06059-I0.75ISO TM...	6	5.90	57	15.0	3	20	0.43
M5	0.80	S04036-I0.8ISO TM...	4	3.60	42	8.0	3	10	0.46
M6	1.00	S06040-I1.0ISO TM...	6	4.00	57	9.0	3	9	0.58
M12	1.00	S08079-I1.0ISOTM...	8	7.90	63	20.0	3, 5 *	20	0.58
M8	1.25	S06050-I1.25ISO TM...	6	5.00	57	12.5	3	10	0.72
M10	1.50	S06059-I1.5ISO TM...	6	5.90	57	15.0	3	10	0.87
M14	1.50	S10099-I1.5ISO TM...	10	9.90	72	24.0	5	16	0.87
M18	1.50	S12119-I1.5ISO TM...	12	11.90	83	30.0	5	20	0.87
M12	1.75	S08079-I1.75ISO TM...	8	7.90	63	19.2	3, 5 *	11	1.01
M16	2.00	S10099-I2.0ISO TM...	10	9.90	72	24.0	5	12	1.15
M18	2.00	S12119-I2.0ISO TM...	12	11.90	83	30.0	5	15	1.15
M20	2.50	S12119-I2.5ISO TM...	12	11.90	83	30.0	5	12	1.44
M24	3.00	S16159-I3.0ISO TM...	16	15.90	92	36.0	5	12	1.73
M30	3.50	S16159-I3.5ISO TM...	16	15.90	92	38.5	5	11	2.02
M36	4.00	S16159-I4.0ISO TM...	16	15.90	92	40.0	5	10	2.31
M48	5.00	S20199-I5.0ISO TM...	20	19.90	104	40.0	5	8	2.89
M64	6.00	S20199-I6.0ISO TM...	20	19.90	104	36.0	5	6	3.46

\* Available with 3 and 5 flutes. Add 3 or 5 to the ordering code (TM3.../TM5...)

## External / Internal

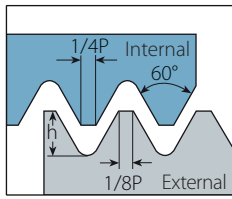

Defined by: ANSI B1.1:74  
Tolerance class: 2A/2B

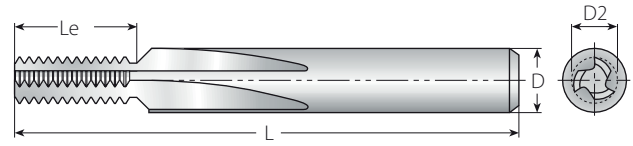

## Straight Flutes - External

Thread	Pitch	Ordering Code	Dimensions mm				No. of Flutes	Teeth	
Min. Dia.	tpi	External	D	D2	L	Le	Z	Zt	h mm
No.6	32	S06059-E32UN TM...	6	5.90	57	14.3	3	18	0.49
No.12	28	S08079-E28UN TM...	8	7.90	63	19.9	3, 5 *	22	0.56
1/4"	20	S10099-E20UN TM...	10	9.90	72	22.9	5	18	0.78
5/16"	18	S10099-E18UN TM...	10	9.90	72	24.0	5	17	0.87
3/8"	16	S12119-E16UN TM...	12	11.90	83	28.6	5	18	0.97
9/16"	12	S12119-E12UN TM...	12	11.90	83	29.6	5	14	1.30
1"	8	S16159-E8UN TM...	16	15.90	92	38.1	5	12	1.95
1 3/8"	6	S20199-E6UN TM...	20	19.90	104	38.1	5	9	2.60

\* Available with 3 and 5 flutes. Add 3 or 5 to the ordering code (TM3.../TM5...)

## Straight Flutes - Internal

Thread	Pitch	Ordering Code	Dimensions mm				No. of Flutes	Teeth	
Min. Dia.	tpi	Internal	D	D2	L	Le	Z	Zt	h mm
No.8	36	S04030-I36UN TM...	4	3.00	42	6.3	3	9	0.41
No.8	32	S04030-I32UN TM...	4	3.00	42	6.3	3	8	0.46
5/16"	32	S06059-I32UN TM...	6	5.90	57	14.3	3	18	0.46
No.12	28	S04036-I28UN TM...	4	3.60	42	8.2	3	9	0.52
7/16"	28	S08079-I28UN TM...	8	7.90	63	19.9	3, 5*	22	0.52
No.12	24	S06040-I24UN TM...	6	4.00	57	8.5	3	8	0.61
1/4"	20	S06040-I20UN TM...	6	4.00	57	10.2	3	8	0.73
9/16"	20	S10099-I20UN TM...	10	9.90	72	22.9	5	18	0.73
5/16"	18	S06050-I18UN TM...	6	5.00	57	12.7	3	9	0.81
9/16"	18	S10099-I18UN TM...	10	9.90	72	24.0	5	17	0.81
3/8"	16	S06059-I16UN TM...	6	5.90	57	14.3	3	9	0.92
3/4"	16	S12119-I16UN TM...	12	11.90	83	28.6	5	18	0.92
7/16"	14	S08079-I14UN TM...	8	7.90	63	18.1	3, 5*	10	1.05
1/2"	13	S08079-I13UN TM...	8	7.90	63	19.5	3, 5*	10	1.13
9/16"	12	S10099-I12UN TM...	10	9.90	72	23.3	5	11	1.22
1"	12	S12119-I12UN TM...	12	11.90	83	29.6	5	14	1.22
5/8"	11	S10099-I11UN TM...	10	9.90	72	23.1	5	10	1.33
3/4"	10	S12119-I10UN TM...	12	11.90	83	27.9	5	11	1.47
7/8"	9	S16159-I9UN TM...	16	15.90	92	33.3	5	12	1.63
1"	8	S16159-I8UN TM...	16	15.90	92	38.1	5	12	1.83
1 1/8"	7	S16159-I7UN TM...	16	15.90	92	36.3	5	10	2.09
1 3/8"	6	S20199-I6UN TM...	20	19.90	104	38.1	5	9	2.44
1 3/4"	5	S20199-I5UN TM...	20	19.90	104	40.6	5	8	2.93
2"	4.5	S20199-I4.5UN TM...	20	19.90	104	39.5	5	7	3.26

\* Available with 3 and 5 flutes. Add 3 or 5 to the ordering code (TM3.../TM5...)

# BSW

# Straight

## External / Internal

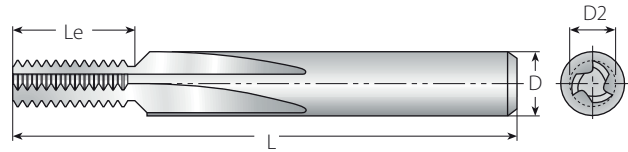
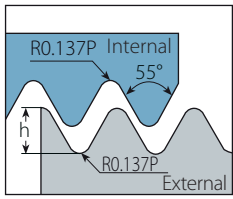

Defined by: B.S.84:1956, DIN 259, ISO228/1:1982  
Tolerance class: Medium class A

## Straight Flutes

Thread	Pitch	Ordering Code	Dimensions mm				No. of Flutes	Teeth	
Min. Dia.	tpi	External / Internal	D	D2	L	Le	Z	Zt	h mm
1/4"	20	S06040-EI20BSW TM...	6	4.00	57	10.16	3	8	0.81
5/16"	18	S06050-EI18BSW TM...	6	5.00	57	11.29	3	8	0.90
3/8"	16	S06059-EI16BSW TM...	6	5.90	57	14.29	3	9	1.02
7/16"	14	S08079-EI14BSW TM...	8	7.90	63	18.14	3, 5*	10	1.16
1/2"	12	S08079-EI12BSW TM...	8	7.90	63	19.05	3, 5*	9	1.36
5/8"	11	S10099-EI11BSW TM...	10	9.90	72	23.09	5	10	1.48
3/4"	10	S12119-EI10BSW TM...	12	11.90	83	27.94	5	11	1.63
7/8"	9	S12119-EI9BSW TM...	12	11.90	83	28.22	5	10	1.81
1"	8	S16159-EI8BSW TM...	16	15.90	92	38.10	5	12	2.03
1 1/8"	7	S16159-EI7BSW TM...	16	15.90	92	36.29	5	10	2.32
1 3/8"	6	S16159-EI6BSW TM...	16	15.90	92	38.10	5	9	2.71
1 5/8"	5	S20199-EI5BSW TM...	20	19.90	104	40.64	5	8	3.25
1 7/8"	4.5	S20199-EI4.5BSW TM...	20	19.90	104	39.51	5	7	3.61

\* Available with 3 and 5 flutes. Add 3 or 5 to the ordering code (TM3.../TM5...)

# BSP

# Straight

## External / Internal

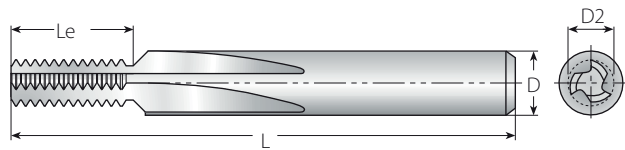
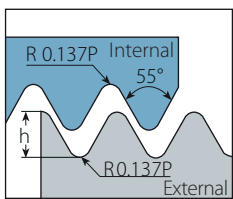

Defined by: B.S.2779:1956  
Tolerance class: Medium class

## Straight Flutes

Thread	Pitch	Ordering Code	Dimensions mm				No. of Flutes	Teeth	
Min. Dia.	tpi	External / Internal	D	D2	L	Le	Z	Zt	h mm
1/16"	28	S06059-EI28BSP TM...	6	5.90	57	14.51	3	16	0.58
1/4"	19	S08079-EI19BSP TM...	8	7.90	63	18.72	3, 5*	14	0.86
1/2"	14	S12119-EI14BSP TM...	12	11.90	83	29.03	5	16	1.16
1"	11	S16159-EI11BSP TM...	16	15.90	92	34.64	5	15	1.48

\* Available with 3 and 5 flutes. Add 3 or 5 to the ordering code (TM3.../TM5...)

# BSPT

# Straight

## External / Internal

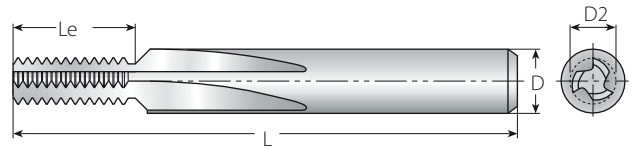
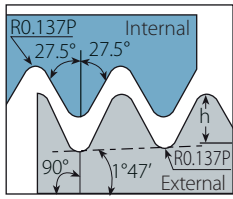

Defined by: B.S.21:1985  
Tolerance class: Standard BSPT

## Straight Flutes

Thread	Pitch	Ordering Code	Dimensions mm				No. of Flutes	Teeth	
Min. Dia.	tpi	External / Internal	D	D2	L	Le	Z	Zt	h mm
1/16"	28	S06059-EI28BSPT TM...	6	5.90	57	9.98	3	11	0.58
1/4"	19	S08079-EI19BSPT TM...	8	7.90	63	14.71	3, 5*	11	0.86
1/2"	14	S12119-EI14BSPT TM...	12	11.90	83	19.96	5	11	1.16
1"	11	S16159-EI11BSPT TM...	16	15.90	92	39.25	5	17	1.48

\* Available with 3 and 5 flutes. Add 3 or 5 to the ordering code (TM3.../TM5...)

# NPT

# Straight

## External / Internal

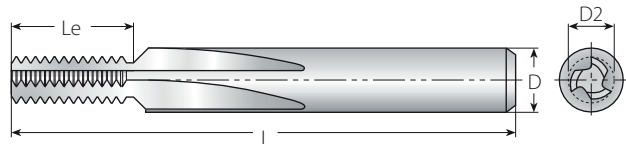
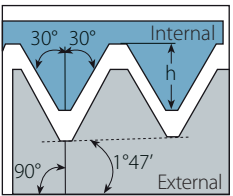

Defined by: USAS B2.1:1968  
Tolerance class: Standard NPT

## Straight Flutes

Thread	Pitch	Ordering Code	Dimensions mm				No. of Flutes	Teeth	
Min. Dia.	tpi	External / Internal	D	D2	L	Le	Z	Zt	h mm
1/16"	27	S06059-EI27NPT TM...	6	5.90	57	9.41	3	10	0.66
1/4"	18	S08079-EI18NPT TM...	8	7.90	63	14.11	3, 5*	10	1.01
1/2"	14	S12119-EI14NPT TM...	12	11.90	83	19.96	5	11	1.33
1"	11.5	S16159-EI11.5NPT TM...	16	15.90	92	26.51	5	12	1.64
2 1/2"	8	S16159-EI8NPT TM...	16	15.90	92	38.10	5	12	2.42

\* Available with 3 and 5 flutes. Add 3 or 5 to the ordering code (TM3.../TM5...)

# NPTF

# Straight

## External / Internal

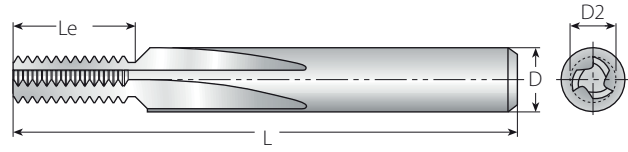
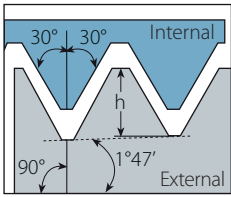

Defined by: ANSI 1.20.3-1976  
Tolerance class: Standard NPTF

## Straight Flutes

Thread	Pitch	Ordering Code	Dimensions mm				No. of Flutes	Teeth	
Min. Dia.	tpi	External / Internal	D	D2	L	Le	Z	Zt	h mm
1/16"	27	S06059-EI27NPTF TM...	6	5.90	57	9.41	3	10	0.64
1/4"	18	S08079-EI18NPTF TM...	8	7.90	63	14.11	3, 5*	10	1.0
1/2"	14	S12119-EI14NPTF TM...	12	11.90	83	19.96	5	11	1.35
1"	11.5	S16159-EI11.5NPTF TM...	16	15.90	92	26.51	5	12	1.63
2 1/2"	8	S16159-EI8NPTF TM...	16	15.90	92	38.10	5	12	2.38

\* Available with 3 and 5 flutes. Add 3 or 5 to the ordering code (TM3.../TM5...)

# Pg

# Straight

## External / Internal

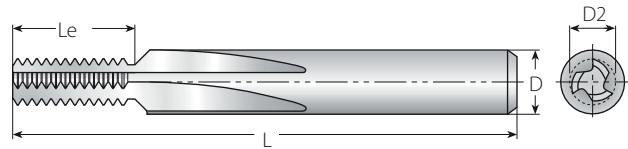
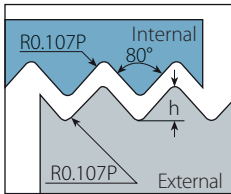

Defined by: DIN 40430  
Tolerance class: Standard

## Straight Flutes

Thread	Pitch	Ordering Code	Dimensions mm				No. of Flutes	Teeth	
	tpi	External / Internal	D	D2	L	Le	Z	Zt	h mm
Pg7	20	S08079-EI20PG TM...	8	7.90	63	19.05	3, 5*	15	0.61
Pg9, 11, 13.5, 16	18	S10099-EI18PG TM...	10	9.90	72	23.99	5	17	0.67
Pg21, 29, 36, 42, 48	16	S12119-EI16PG TM...	12	11.90	83	28.58	5	18	0.76

\* Available with 3 and 5 flutes. Add 3 or 5 to the ordering code (TM3.../TM5...)

# Grades and Their Applications

## VTH

Helicool

HCR

HCC

MilliPro

MilliPro Dental

MilliPro HD

MilliPro EL

Deep Threading

Helical

- A general-purpose, heavy duty thread milling grade
- TiCN coated for high resistance to wear

## VTS

Straight

- A general-purpose grade, specially designed for TM Solid Straight Flute cutters
- TiAlN coated for high resistance to wear

## VTS

HTC (Thriller)

- TiAlN coated grade
- First choice for Cast iron and general use

## VTN

HTC (Thriller)

- Uncoated grade
- First choice for Aluminium and general use



TM Gen Software and updated versions can be downloaded from [www.vargus.com](http://www.vargus.com)

## Cutting Speeds Vc [m/min] and Feed f [mm/tooth]

Material Group	Vardex No.	Material	Hardness Brinell HB	Vc [m/min]			Feed [mm/tooth]					
				Helicool, HCR, HCC, Helical, Sraight, Deep Threading		MilliPro	Helical	Straight	Deep Threading	Helicool HCC HCR	MilliPro	
				VTH	VTS	VTH						
<b>P</b> Steel	1	Unalloyed steel	Low carbon (C=0.1-0.25%)	125	80-250	50-180	60-120	0.03-0.15	0.01-0.1	0.10-0.35	0.025-0.3	0.02-0.16
	2		Medium carbon (C=0.25-0.55%)	150	80-230	50-140	60-120	0.03-0.1	0.01-0.08	0.08-0.30	0.02-0.26	0.02-0.16
	3		High Carbon (C=0.55-0.85%)	170	80-200	50-120	60-90	0.03-0.08	0.01-0.06	0.08-0.30	0.02-0.23	0.02-0.16
	4	Low alloy steel (alloying elements ≤5%)	Non hardened	180	60-180	60-170	60-90	0.03-0.1	0.03-0.07	0.08-0.30	0.02-0.22	0.015-0.16
	5		Hardened	275	60-170	60-160	50-80	0.03-0.07	0.03-0.07	0.08-0.30	0.01-0.15	0.015-0.07
	6		Hardened	350	60-160	60-150	50-80	0.01-0.03	0.005-0.01	0.05-0.15	0.01-0.1	0.015-0.03
	7	High alloy steel (alloying elements >5%)	Annealed	200	40-100	40-90	50-80	0.03-0.05	0.01-0.03	0.10-0.24	0.01-0.13	0.015-0.09
	8		Hardened	325	30-80	30-70	50-80	0.01-0.03	0.005-0.01	0.05-0.15	0.01-0.12	0.015-0.03
	9	Cast steel	Low alloy (alloying elements <5%)	200	80-250	70-200	70-90	0.03-0.1	0.01-0.03	0.08-0.30	0.01-0.15	0.015-0.16
	10		High alloy (alloying elements >5%)	225	60-170	60-150	60-80	0.01-0.03	0.005-0.01	0.05-0.15	0.01-0.1	0.015-0.03
<b>M</b> Stainless Steel	11	Stainless steel Ferritic	Non hardened	200	60-150	50-140	60-90	0.04-0.1	0.01-0.05	0.11-0.35	0.01-0.13	0.015-0.16
	12		Hardened	330	60-120	50-110	50-80	0.01-0.05	0.005-0.01	0.05-0.24	0.01-0.12	0.015-0.03
	13	Stainless steel Austenitic	Austenitic	180	60-140	60-130	60-90	0.04-0.1	0.007-0.02	0.11-0.35	0.01-0.12	0.015-0.16
	14		Super Austenitic	200	60-130	50-120	50-80	0.04-0.1	0.007-0.02	0.11-0.35	0.01-0.1	0.015-0.16
	15	Stainless steel Cast Ferritic	Non hardened	200	60-160	50-150	60-90	0.04-0.1	0.01-0.03	0.11-0.35	0.01-0.15	0.015-0.16
	16		Hardened	330	60-110	50-100	50-80	0.03-0.05	0.005-0.01	0.10-0.24	0.01-0.1	0.015-0.03
	17	Stainless steel Cast austenitic	Austenitic	200	60-150	50-140	60-90	0.04-0.1	0.01-0.03	0.11-0.35	0.01-0.12	0.015-0.16
	18		Hardened	330	60-100	50-90	50-80	0.03-0.05	0.005-0.01	0.10-0.24	0.01-0.1	0.015-0.03
<b>K</b> Cast Iron	28	Malleable Cast iron	Ferritic (short chips)	130	60-70	60-150	50-80	0.01-0.03	0.007-0.02	0.05-0.15	0.01-0.15	0.015-0.03
	29		Pearlitic (long chips)	230	60-150	80-100	60-90	0.03-0.05	0.005-0.01	0.10-0.24	0.01-0.12	0.02-0.12
	30	Grey cast iron	Low tensile strength	180	70-160	50-140	70-100	0.025-0.1	0.007-0.02	0.09-0.25	0.01-0.13	0.02-0.16
	31		High tensile strength	260	40-120	40-110	60-90	0.03-0.05	0.005-0.01	0.10-0.24	0.01-0.12	0.02-0.12
	32	Nodular SG iron	Ferritic	160	40-110	40-100	70-100	0.05-0.1	0.007-0.02	0.09-0.25	0.01-0.13	0.02-0.16
	33		Pearlitic	260	40-100	40-90	60-90	0.03-0.05	0.005-0.01	0.10-0.24	0.01-0.12	0.02-0.12
<b>N(K)</b> Non-Ferrous Metals	34	Aluminium alloys Wrought	Non aging	60	200-300	150-250	60-250	0.1-0.25	0.05-0.15	0.12-0.40	0.04-0.4	0.025-0.15
	35		Aged	100	150-250	100-220	60-150	0.1-0.2	0.03-0.1	0.10-0.32	0.03-0.36	0.025-0.16
	36	Aluminium alloys	Cast	75	100-200	80-150	60-250	0.1-0.2	0.05-0.15	0.10-0.32	0.03-0.36	0.025-0.16
	37		Cast & aged	90	120-220	90-160	60-150	0.1-0.15	0.03-0.1	0.10-0.30	0.1-0.3	0.015-0.16
	38	Aluminium alloys	Cast Si 13-22%	130	200-300	150-250	250	0.1-0.2	0.05-0.15	0.10-0.32	0.03-0.36	0.03-0.15
	39	Copper and copper alloys	Brass	90	200-300	150-250	60-250	0.1-0.25	0.05-0.15	0.12-0.40	0.04-0.43	0.025-0.16
	40		Bronze and non leaded copper	100	150-250	100-220	60-150	0.1-0.2	0.03-0.1	0.10-0.32	0.03-0.36	0.03-0.15
	<b>S(M)</b> Heat Resistant Material	19	High temperature alloys	Annealed (Iron based )	200	30-60	30-50	60	0.04-0.1	0.007-0.02	0.11-0.35	0.007-0.09
20		Aged (Iron based)		280	20-50	20-40	50	0.01-0.03	0.005-0.01	0.05-0.15	0.006-0.07	0.015-0.03
21		Annealed (Nickel or Cobalt based)		250	15-35	15-30	35	0.01-0.03	0.005-0.01	0.05-0.15	0.005-0.06	0.015-0.03
22		Aged (Nickel or Cobalt based)		350	15-30	15-25	30	0.01-0.03	0.005-0.01	0.05-0.15	0.005-0.06	0.015-0.03
23		Titanium alloys	Pure 99.5 Ti	400Rm	40-80	30-70	30-50	0.03-0.05	0.007-0.02	0.10-0.24	0.006-0.07	0.015-0.07
24	α+β alloys		1050Rm	20-50	20-45	25-35	0.03-0.05	0.007-0.02	0.10-0.24	0.006-0.07	0.015-0.07	
<b>H(K)</b> Hardened Material	25	Extra hard steel	Hardened & tempered	45-50Hrc	15-45	15-35	45	0.005-0.01	0.003-0.006	0.025-0.06	0.004-0.04	0.01-0.04
	26			51-55Hrc	15-40	15-30	30	0.005-0.01	0.003-0.006	0.025-0.06	0.004-0.04	-

**\* Recommendation:**

At tool entry, set the Feed f [mm/tooth] to 70% lower than the threading Feed.

**Example:**

Threading Feed: 0.3[mm/tooth]

Tool entry Feed: 0.09[mm/tooth]

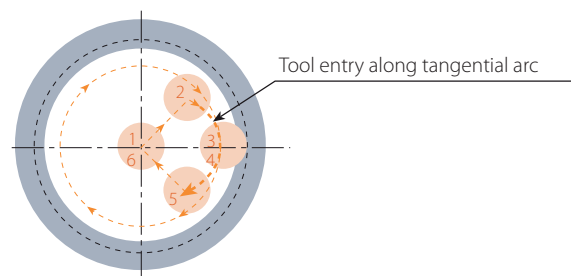



## MilliPro HD Cutting Speeds Vc [m/min] and Feed f [mm/tooth]

Material Group	Vardex No.	Material		Hardness Brinell HB	Feed f [mm/tooth] by Cutting Dia.=D2					
					Vc [m/min]	1.5-2.5	2.5-5	5-7	7-9	9-11
<b>P</b> Steel	6	Low alloy steel (alloying elements≤5%)	Hardened	350	25-160	0.04	0.05	0.06	0.07	0.08
	8	High alloy steel (alloying elements>5%)	Hardened	325	25-180					
<b>M</b> Stainless Steel	12	Stainless steel Ferritic	Hardened	330	25-120	0.04	0.05	0.06	0.07	0.08
	16	Stainless steel Cast Ferritic	Hardened	330	25-110					
	18	Stainless steel Cast Austenitic	Hardened	330	25-100					
<b>K</b> Cast Iron	28	Malleable cast iron	Ferritic (short chips)	130	25-160	0.05	0.06	0.07	0.08	0.1
	29		Pearlitic (long chips)	230	25-150	0.04	0.05	0.06	0.07	0.08
	30	Grey cast iron	Low tensile strength	180	25-130	0.05	0.06	0.07	0.08	0.1
	31		High tensile strength	260	25-100	0.04	0.05	0.06	0.07	0.08
	32	Nodular SG iron	Ferritic	160	25-125	0.04	0.05	0.06	0.07	0.09
	33		Pearlitic	260	25-90	0.03	0.04	0.05	0.06	0.07
<b>S(M)</b> Heat Resistant Material	21	High temperature alloys	Annealed (Nickel or Cobalt based)	250	15-35	0.03	0.04	0.05	0.06	0.07
	22		Aged (Nickel or Cobalt based)	350	15-30					
	23	Titanium alloys	Pure 99.5 Ti	400Rm	25-70					
	24		α+β alloys	1050Rm	25-50					
<b>H(K)</b> Hardened Material	25	Extra hard steel	Hardened & tempered	45-50HRc	25-70	0.04	0.05	0.06	0.07	0.08
	26			51-55HRc	25-60	0.03	0.04	0.05	0.06	0.07
	27			56-62HRc	25-50	0.02	0.03	0.04	0.05	0.06

## HTC Recommended Grades, Cutting Speed and Feed

Material Group	Material		Hardness Brinell HB	Strength (N-mm <sup>2</sup> )	Vc[m/min]		fb[mm/rev]		fz[mm/tooth]	
					VTN	VTS	≤6mm	≤12mm	≤6mm	≤12mm
<b>K</b> Cast Iron	Cast Iron	Grey cast iron	≤150	≤500	50-80	80-120	0.10-0.15	0.15-0.22	0.02-0.05	0.05-0.10
		Grey cast iron, heat treated	150-300	500-1000	50-80	80-120	0.10-0.15	0.15-0.22	0.02-0.05	0.05-0.10
		Spher. graph. Cast Iron	≤200	≤700	50-80	80-120	0.10-0.15	0.15-0.22	0.02-0.05	0.05-0.10
	Copper	Short Chips, Brass, Bronze, Red Brass	≤200	≤700	100-300	—	0.10-0.30	0.06-0.10	0.03-0.06	0.06-0.10
<b>N(K)</b> Non-Ferrous Metals	Aluminium/Magnesium	Aluminium, Magnesium non-alloy	≤100	≤350	100-400	100-400	0.10-0.25	0.25-0.30	0.03-0.06	0.06-0.10
		Aluminium, Wrought Alloy, Breaking Strain (A5) < 14%	≤180	≤600	100-400	100-400	0.10-0.25	0.25-0.30	0.03-0.06	0.06-0.10
		Aluminium, Wrought Alloy, Breaking Strain (A5) ≥ 14%	≤180	≤600	100-400	100-400	0.03-0.06	0.06-0.12	0.03-0.06	0.06-0.10
		Aluminium, Cast Alloy, Si<10%	≤180	≤600	100-300	100-400	0.10-0.25	0.25-0.30	0.03-0.06	0.06-0.10
		Aluminium, Cast Alloy, Si≥10%	≤180	≤600	—	100-300	0.10-0.25	0.25-0.30	0.03-0.06	0.06-0.10
<b>K</b> Cast Iron	Plastic	Thermoplastics	—	—	60-120	60-120	0.10-0.25	0.25-0.30	0.03-0.06	0.06-0.10
		Thermosetting Plastic	—	—	60-100	60-100	0.10-0.25	0.25-0.30	0.03-0.06	0.06-0.10
		Fibre Reinforce Plastic	—	—	40-60	60-80	0.10-0.15	0.15-0.22	0.02-0.05	0.05-0.10

Vc - Cutting Speed [m/min]

fb (Drilling) - Feed per Revolution [mm/rev]

fz (Threading) - Feed per Tooth [mm/tooth]



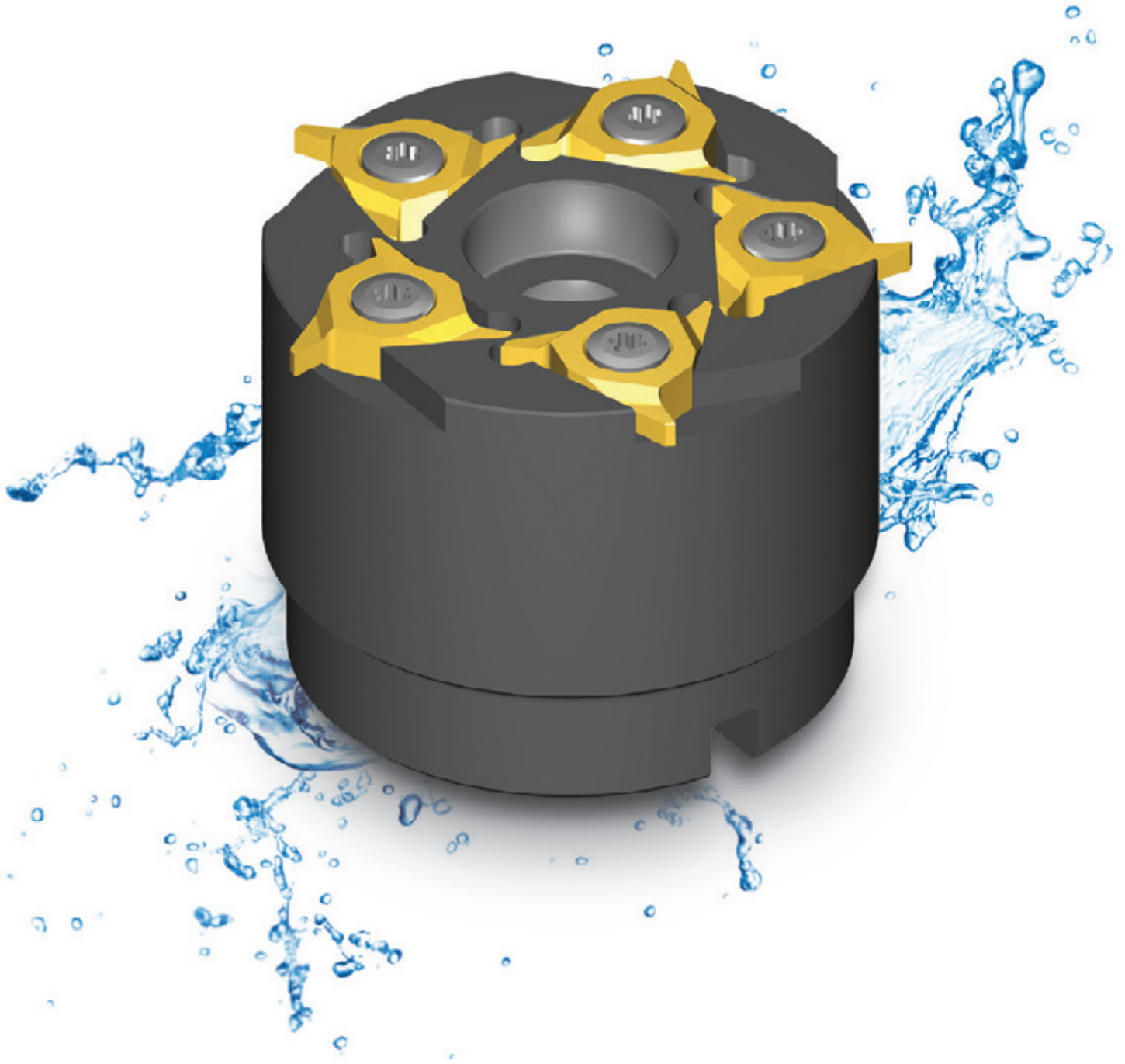

# Groove Milling

- > Inserts
- > Toolholders
- > Technical Data

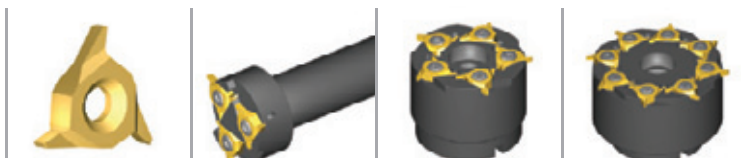

# GROOVE MILLING INSERTS

- VARDEX Ordering Code ..... Page 322
- Circlip Non Standard ..... Page 323
- Circlip DIN 471/472 ..... Page 324
- O Ring DIN 3770 ..... Page 324
- O Ring BS 1806, DIN 3601, DIN 3771 ..... Page 325
- O Ring BS 4518 ..... Page 325
- Groove Milling Holders ..... Page 326
- Groove Milling Technical Data ..... Page 328

## VarDEX Ordering Code System

### Groove Milling Inserts

4	W	GM	1.6	C	-	D3770	S	-	1.38	VKX
1	2	3	4	5		6	7		8	9
<b>1 - Insert Size</b>		<b>2 - Insert Style</b>			<b>3 - System</b>		<b>4 - Groove Std. Width</b>			
4 - IC1/2"		W - Vertical Wide Inserts			GM - Groove Milling		1.1 - 3.15			
<b>5 - Profile Shape</b>		<b>6 - Groove Standard</b>			<b>7 - Groove Type</b>		<b>8 - Groove Depth</b>			
C - With Chamfer		CIRC - Circlip DIN471/472 DIN3770D DIN3770S BS1806 BS4518			D - Dynamic S - Static DP- Dynamic pneumatic DH- Dynamic hydraulic		0.3 - 3.8			
							<b>9 - Carbide Grade</b>			
							VKX			

### Groove Milling Shell Mill

SGM	-	D48	-	25	-	4
1		2		3		4
<b>1 - System</b>		<b>2 - Cutting Dia.</b>		<b>3 - Drive Hole Dia.</b>		<b>4 - Insert Size</b>
SGM - Shell Groove Milling		48, 63, 80		22, 25, 27		4 - IC1/2"

# Circlip Non Standard

External / Internal

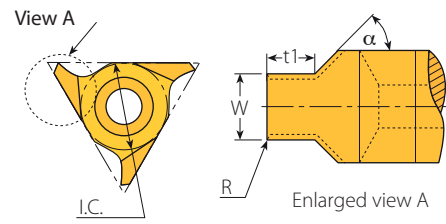
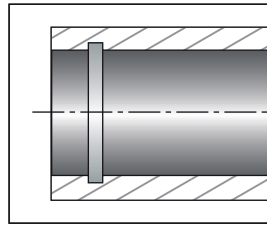
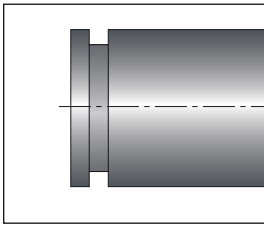

Vertical SGM

## Vertical SGM

Insert Size		Ordering Code	Dimensions mm			$\alpha$	Toolholder
IC	L mm		W	R	t1		
1/2"	22	4WGM1.25C-CIRC-1.5...	1.25	0.2	1.3	45°	SGM-D...-4
		4WGM1.35C-CIRC-1.5...	1.35	0.2	1.3		
		4WGM1.45C-CIRC-1.5...	1.45	0.2	1.3		
		4WGM1.50C-CIRC-1.5...	1.50	0.2	1.3		
		4WGM1.65C-CIRC-2.0...	1.65	0.2	1.8		
		4WGM1.75C-CIRC-2.0...	1.75	0.2	1.8		
		4WGM1.85C-CIRC-2.50...	1.85	0.2	2.3		
		4WGM2.00C-CIRC-2.50...	2.00	0.2	2.3		
		4WGM2.20C-CIRC-3.50...	2.20	0.2	3.3		
		4WGM2.30C-CIRC-3.50...	2.30	0.2	3.3		
		4WGM2.50C-CIRC-3.50...	2.50	0.3	3.3		
		4WGM2.65C-CIRC-3.50...	2.65	0.3	3.3		
		4WGM2.70C-CIRC-3.50...	2.70	0.3	3.3		
		4WGM2.80C-CIRC-3.50...	2.80	0.3	3.3		
		4WGM3.00C-CIRC-3.50...	3.00	0.3	3.3		
		4WGM3.20C-CIRC-3.50...	3.20	0.3	3.3		
		4WGM3.30C-CIRC-3.50...	3.30	0.3	3.3		
		4WGM3.50C-CIRC-4.00...	3.50	0.3	3.8		
		4WGM3.70C-CIRC-4.00...	3.70	0.3	3.8		
		4WGM3.90C-CIRC-4.00...	3.90	0.3	3.8		
4WGM4.00C-CIRC-4.00...	4.00	0.3	3.8				



# Circlip DIN 471/472

External / Internal

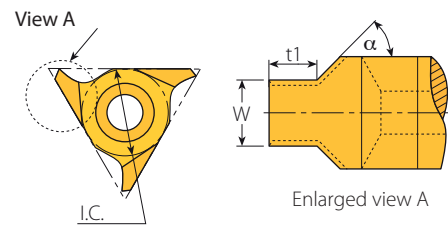
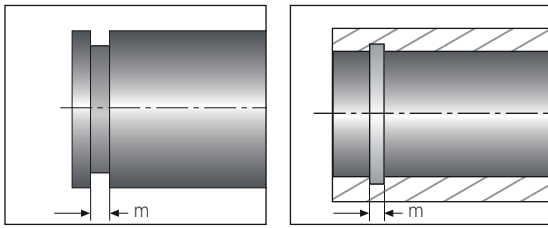

Vertical SGM

## Vertical SGM

Insert Size		Ordering Code	Groove Std.			$\alpha$	Toolholder
IC	L mm		*m(H13)	W	t1		
1/2"	22	4WGM1.1C-D471/472-0.35...	1.10	1.19	0.3	45°	SGM-D...-4
		4WGM1.1C-D471/472-0.40...	1.10	1.19	0.4		
		4WGM1.3C-D471/472-0.50...	1.30	1.39	0.4		
		4WGM1.3C-D471/472-0.55...	1.30	1.39	0.5		
		4WGM1.6C-D471/472-0.70...	1.60	1.69	0.6		
		4WGM1.6C-D471/472-0.85...	1.60	1.69	0.8		
		4WGM1.6C-D471/472-1.00...	1.60	1.69	0.9		
		4WGM1.85C-D471/472-1.25...	1.85	1.94	1.1		
		4WGM1.85C-D471/472-1.00...	1.85	1.94	0.9		
		4WGM2.15C-D471/472-1.50...	2.15	2.24	1.4		
		4WGM2.65C-D471/472-1.50...	2.65	2.74	1.4		
		4WGM2.65C-D471/472-1.75...	2.65	2.74	1.6		
		4WGM3.15C-D471/472-1.75...	3.15	3.24	1.6		



# O Ring DIN 3770

External / Internal

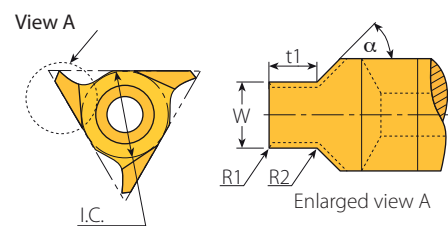
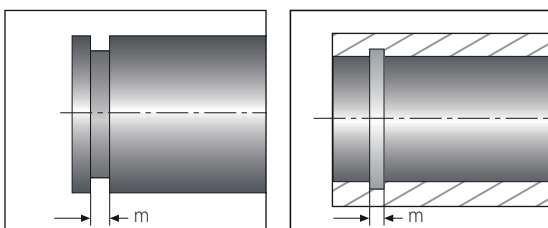

Vertical SGM

## Vertical SGM

Insert Size		Ordering Code	Groove Std.				$\alpha$	Toolholder		
IC	L mm	St.Dy	*m(H13)	W	t	R1	R2			
1/2"	22	St.	4WGM1.6C-D3770S-1.38...	1.60	1.97	1.38	0.25	0.10	75°	SGM-D...-4
			4WGM2.0C-D3770S-1.72...	2.00	2.37	1.72	0.25	0.10		
			4WGM2.5C-D3770S-2.15...	2.50	3.02	2.15	0.25	0.10		
		Dy.	4WGM3.15C-D3770S-2.70...	3.15	3.77	2.70	0.60	0.20		
			4WGM1.6C-D3770D-1.47...	1.60	1.97	1.47	0.25	0.10		
			4WGM2.0C-D3770D-1.83...	2.00	2.37	1.83	0.25	0.10		



St. = Static

Dy. = Dynamic

# O Ring BS 1806, DIN3601, DIN 3771

External / Internal

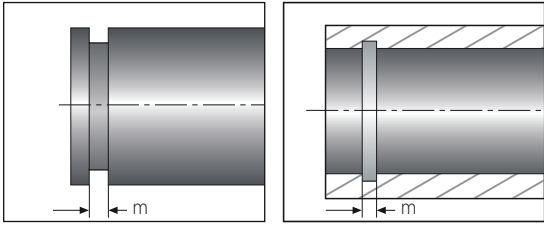
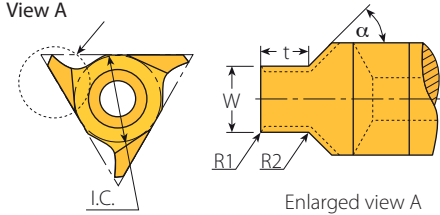
Vertical SGM

## Vertical SGM



Insert Size		Ordering Code			Groove Std.				$\alpha$	Toolholder
IC	L mm	St.	Dy	*m(H13)	W	t	R1	R2		
1/2"	22	St.	4WGM1.80C-BS1806S-1.3...	1.80	2.37	1.30	0.6	0.2	75°	SGM-D...-4
			4WGM2.65C-BS1806S-2.0...	2.65	3.57	2.00	0.6	0.2		
		Dy.	4WGM1.80C-BS1806D-1.57...	1.80	2.37	1.55	0.6	0.2		
			4WGM2.65C-BS1806D-2.38...	2.65	3.57	2.30	0.6	0.2		

St. = Static  
Dy. = Dynamic

# BS 4518

External / Internal

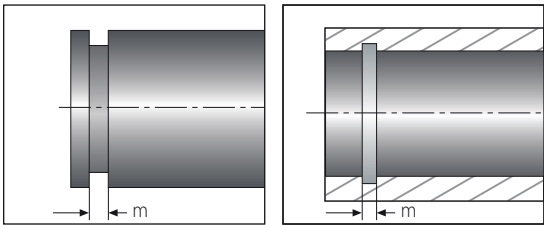
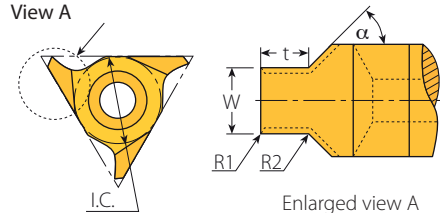
Vertical SGM

## Vertical SGM



Insert Size		Ordering Code			Groove Std.				$\alpha$	Toolholder
IC	L mm	St.	Dy	*m(H13)	W	t	R1	R2		
1/2"	22	St.	4WGM1.6C-BS4518S-1.25...	1.60	2.37	1.25	0.5	0.2	75°	SGM-D...-4
			4WGM2.4C-BS4518S-1.95...	2.40	3.17	1.95	0.5	0.2		
			4WGM3.0C-BS4518S-2.51...	3.00	3.77	2.51	1.0	0.2		
		DyP	4WGM2.4C-BS4518DP-2.20...	2.40	3.27	2.20	0.5	0.2		
			4WGM3.0C-BS4518DP-2.77...	3.00	4.07	2.77	1.0	0.2		
			DyH	4WGM2.4C-BS4518DH-2.09...	2.40	3.27	2.09	0.5		
4WGM3.0C-BS4518DH-2.60...	3.00	4.07		2.60	1.0	0.2				

St. = Static  
DyP = Dynamic pneumatic  
DyH = Dynamic hydraulic

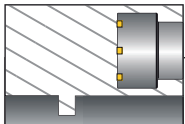

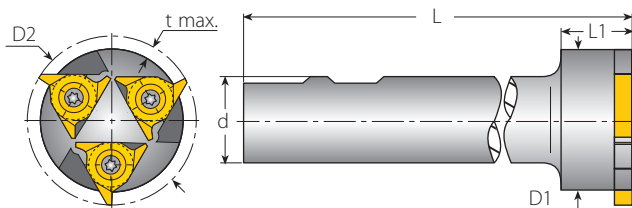

## Toolholders



### Multi Insert Holders (3)

#### Spare Parts

Insert Size	Ordering Code	Dimensions mm						Spare Parts	
IC		D2	t max	L	L1	d	D1		
1/2"	SGM-D48-25-4	48	3.5	125	20	25	40	Insert Screw SN4T-90	Torx Key HK4T

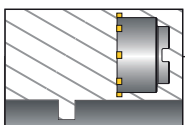

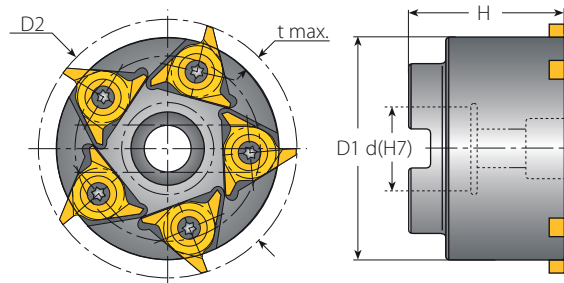

## Toolholders



### Multi Insert Holders (5)

#### Spare Parts

Insert Size	Ordering Code	Dimensions mm					Spare Parts		
IC		D2	t max	d(H7)	D1	H			
1/2"	SGM-D63-22-4	63	3.5	22	54.0	41	Insert Screw SN4T-90	Torx Key HK4T	Holder Screw M10x1.5x35



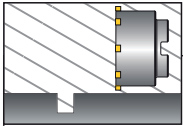

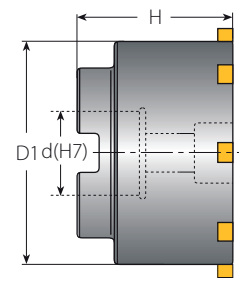
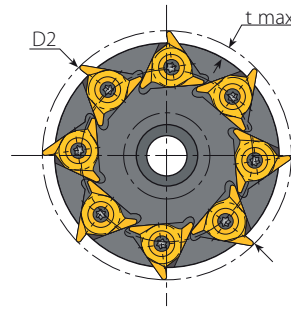
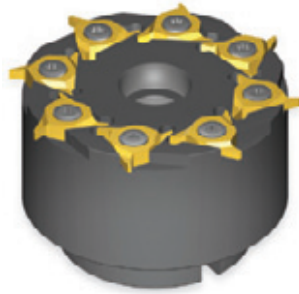

# Toolholders



## Multi Insert Holders (8)

### Spare Parts

Insert Size	Ordering Code	Dimensions mm					Spare Parts		
IC		D2	t max	d(H7)	D1	H			
1/2"	SGM-D80-27-4	80	3.5	27	72	50	Insert Screw SN4T-90	Torx Key HK4T	Holder Screw M12x1.75x40

## Recommended Grades, Cutting Speeds Vc [m/min], Feed f [mm/ tooth].

Material Group	Vardex No.	Material	Hardness Brinell HB	Vc [mm/min]	Feed f [mm/tooth]	
				VKX	f	
<b>P</b> Steel	1	Unalloyed steel	Low carbon (C=0.1-0.25%)	125	100-220	0.05-0.1
	2		Medium carbon (C=0.25-0.55%)	150	100-170	0.03-0.07
	3		High Carbon (C=0.55-0.85%)	170	100-160	0.02-0.05
	4	Low alloy steel (alloying elements ≤5%)	Non hardened	180	80-150	0.05-0.09
	5		Hardened	275	70-140	0.03-0.07
	6		Hardened	350	70-130	0.02-0.05
	7	High alloy steel (alloying elements >5%)	Annealed	200	70-120	0.03-0.07
	8		Hardened	325	70-100	0.03-0.05
	9	Cast steel	Low alloy (alloying elements <5%)	200	70-110	0.03-0.05
	10		High alloy (alloying elements >5%)	225	50-80	0.02-0.05
<b>M</b> Stainless Steel	11	Stainless steel Ferritic	Non hardened	200	80-150	0.03-0.07
	12		Hardened	330	80-150	0.03-0.05
	13	Stainless steel Austenitic	Austenitic	180	60-120	0.03-0.07
	14		Super Austenitic	200	60-120	0.03-0.05
	15	Stainless steel Cast Ferritic	Non hardened	200	60-120	0.02-0.05
	16		Hardened	330	60-120	0.01-0.03
	17	Stainless steel Cast austenitic	Austenitic	200	50-100	0.03-0.05
	18		Hardened	330	50-100	0.01-0.03
<b>K</b> Cast Iron	28	Malleable Cast iron	Ferritic (short chips)	130	60-110	0.02-0.05
	29		Pearlitic (long chips)	230	50-100	0.01-0.03
	30	Grey cast iron	Low tensile strength	180	60-110	0.03-0.07
	31		High tensile strength	260	50-80	0.03-0.05
	32	Nodular SG iron	Ferritic	160	50-100	0.03-0.05
	33		Pearlitic	260	40-70	0.03-0.05
<b>N(K)</b> Non-Ferrous Metals	34	Aluminium alloys Wrought	Non aging	60	100-200	0.07-0.15
	35		Aged	100	100-150	0.03-0.05
	36	Aluminium alloys	Cast	75	100-180	0.07-0.15
	37		Cast & aged	90	60-120	0.05-0.1
	38	Aluminium alloys	Cast Si 13-22%	130	100-150	0.05-0.1
	39	Copper and copper alloys	Brass	90	60-120	0.05-0.1
	40		Bronze and non leaded copper	100	50-100	0.3-0.08
<b>S(M)</b> Heat Resistant Material	19	High temperature alloys	Annealed (Iron based)	200	20-45	0.01-0.03
	20		Aged (Iron based)	280	20-30	0.01-0.03
	21		Annealed (Nickel or Cobalt based)	250	10-20	0.01-0.03
	22		Aged (Nickel or Cobalt based)	350	10-15	0.01-0.03
	23	Titanium alloys	Pure 99.5 Ti	400Rm	60-120	0.02-0.05
	24		α+β alloys	1050Rm	20-50	0.01-0.03
<b>H(K)</b> Hardned Material	25	Extra hard steel	Hardened & tempered	45-50HRC	15-45	0.05-0.1
	26			51-55HRC	15-40	0.05-0.1

\* Peripheral feed

### Grades and Their Application

Grade	Application Type	Sample
VKX	Excellent for general use TiN coated	

$$N = \frac{1000 \times V_c}{\pi \times D} \quad V_c = \frac{N \times \pi \times D}{1000}$$

- N - Rotational Velocity [R.P.M.]
- V - Cutting Speed [m/min]
- D2 - Toolholder Cutting Dia. [mm]
- F1 - Tool Feed Rate at the Cutting Edge [mm/min]
- z - No. of Cutting Edges
- f - Feed per Tooth per Rotation [mm/tooth]

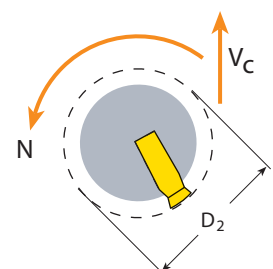











## VARDEX WORLDWIDE



Vargus Ltd. Headquarters ☎ +972 4 9855101 [mrktg@vargus.com](mailto:mrktg@vargus.com)

	<b>China</b>	Vargus China Neumo-Vargus (Shanghai) Trading Co. Ltd.	☎ +86 215239 5005/6/9	<a href="mailto:info@varguschina.net">info@varguschina.net</a>
	<b>Denmark</b>	Vargus Denmark Damstahl Tooling A/S	☎ +45 8794 4100	<a href="mailto:tooling@damstahl.com">tooling@damstahl.com</a>
	<b>France</b>	Vargus France	☎ +33 1 4601 7060	<a href="mailto:commercial@vargus.fr">commercial@vargus.fr</a>
	<b>Germany</b>	Vargus Germany	☎ +49 7043 36 161	<a href="mailto:info@vargus.de">info@vargus.de</a>
	<b>India</b>	Vargus India	☎ +91 98990 73393	<a href="mailto:prasad@vargusindia.com">prasad@vargusindia.com</a>
	<b>Israel</b>	Vargus Israel Neumo-Vargus Marketing Ltd	☎ +972 3 537 3275	<a href="mailto:neumo@neumo-vargus.co.il">neumo@neumo-vargus.co.il</a>
	<b>Poland</b>	Vargus Poland Neumo-Polska Sp. Z.O.O.	☎ +48 46 834 9904 ☎ +48 603 888 064	<a href="mailto:vargus@neumo.pl">vargus@neumo.pl</a>
	<b>Switzerland</b>	Vargus Switzerland Werkzeugtechnik (Snel AG)	☎ +41 41784 2121	<a href="mailto:info@vargus.ch">info@vargus.ch</a>
	<b>United Kingdom</b>	Vargus Tooling UK Ltd.	☎ +1 44 1952 583 222	<a href="mailto:tooling.uk@vargustooling.co.uk">tooling.uk@vargustooling.co.uk</a>
	<b>USA</b>	Vargus USA Vardex USA	☎ +1 800 828 8765 ☎ +608 756 4930	<a href="mailto:sales@vargususa.com">sales@vargususa.com</a>

For the complete list of VARDEX worldwide distributors, visit our website at [www.vargus.com](http://www.vargus.com)



**TT GEN and TM GEN**

Thread Turning and Thread Milling  
 Software for Tool Selection & CNC Program Generator  
 The latest version can be downloaded from  
[www.vargus.com](http://www.vargus.com)

**VARDEX**  
 Advanced Threading Solutions



Tawit Design Group Ltd.