

Additional
short shank
type!

IMPACT MIRACLE Long Neck Ball Nose End Mill Series

VF-2XLB ^{NEW} **VF-2XLB5**

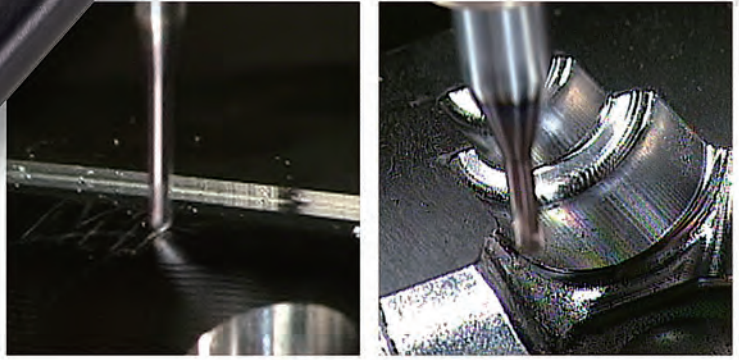

■ New short shank type suitable for use with HSK and shrink fit holders now available!

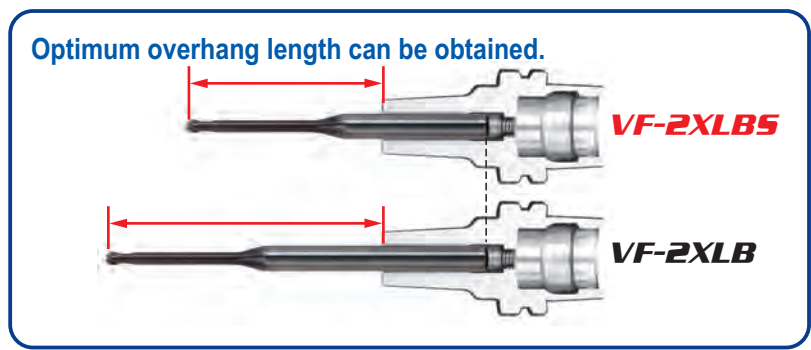

■ Newly developed "Impact Miracle Coating".
■ 217 sizes available.

IMPACT

IMPACT MIRACLE END MILLS

VF-2XLBS NEW

Ball nose, Long neck, 2 flute, Short shank, For hardened materials

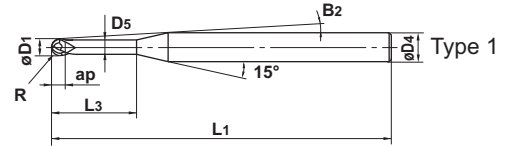

Effective length for inclined angle

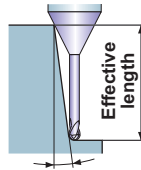

Inclined angle

- 2 flute long neck ball nose end mill for high hardened steels.
- Short shank type ideal for use with shrink fit holders.

Unit : mm

Order Number	Radius of Ball Nose R	Dia. D1	Length of Cut ap	Neck Length L3	Cutting Edge to Shank Angle B2	Neck Dia. D5	Overall Length L1	Shank Dia. D4	No. of Flutes N	Stock	Type	Effective Length for Inclined Angle			
												30°	1°	2°	3°
VF2XLBSR0020N010	0.2	0.4	0.32	1	13.4°	0.36	40	4	2	●	1	1.0	1.0	1.1	1.2
R0020N020	0.2	0.4	0.32	2	11.9°	0.36	40	4	2	●	1	2.0	2.1	2.3	2.5
R0020N030	0.2	0.4	0.32	3	10.7°	0.36	40	4	2	●	1	3.1	3.2	3.4	3.7
R0020N040	0.2	0.4	0.32	4	9.7°	0.36	40	4	2	●	1	4.1	4.3	4.6	4.9
R0025N040	0.25	0.5	0.4	4	9.6°	0.46	40	4	2	●	1	4.1	4.3	4.6	4.9
R0025N060	0.25	0.5	0.4	6	8.1°	0.46	40	4	2	●	1	6.2	6.4	6.9	7.4
R0030N020	0.3	0.6	0.48	2	11.8°	0.56	40	4	2	●	1	2.1	2.2	2.3	2.5
R0030N030	0.3	0.6	0.48	3	10.5°	0.56	40	4	2	●	1	3.1	3.3	3.5	3.8
R0030N040	0.3	0.6	0.48	4	9.5°	0.56	40	4	2	●	1	4.2	4.3	4.6	5.0
R0030N060	0.3	0.6	0.48	6	8.0°	0.56	40	4	2	●	1	6.3	6.5	6.9	7.5
R0040N040	0.4	0.8	0.64	4	9.4°	0.76	40	4	2	●	1	4.2	4.3	4.6	5.0
R0040N060	0.4	0.8	0.64	6	7.8°	0.76	40	4	2	●	1	6.3	6.5	6.9	7.5
R0050N030	0.5	1	0.8	3	10.1°	0.94	40	4	2	●	1	3.2	3.3	3.6	3.9
R0050N040	0.5	1	0.8	4	9.1°	0.94	40	4	2	●	1	4.2	4.4	4.8	5.2
R0050N060	0.5	1	0.8	6	7.5°	0.94	40	4	2	●	1	6.3	6.6	7.1	7.7
R0050N080	0.5	1	0.8	8	6.4°	0.94	40	4	2	●	1	8.4	8.8	9.4	10.2
R0100N060	1	2	1.6	6	6.4°	1.9	40	4	2	●	1	6.2	6.5	6.9	7.4
R0100N080	1	2	1.6	8	5.3°	1.9	40	4	2	●	1	8.3	8.7	9.2	9.9
R0100N100	1	2	1.6	10	4.5°	1.9	40	4	2	●	1	10.4	10.8	11.5	12.4

VF-2XLB

Ball nose, Long cut length, 2 flute, For hardened materials



R ≤ 1 ±0.007
1 < R ±0.010



0 - -0.02



Effective length for inclined angle

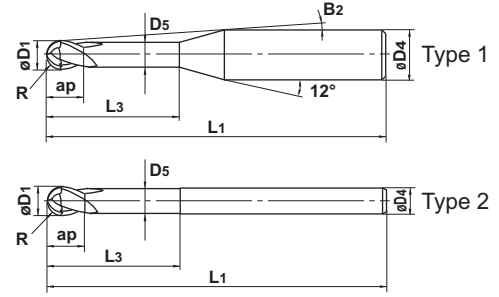
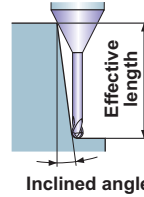

● 2 flute long neck ball nose end mill for high hardened materials.

Unit : mm

Order Number	Radius of Ball Nose R	Dia. D1	Length of Cut ap	Length of Cut L3	Cutting Edge to Shank Angle B2	Neck Dia. D5	Overall Length L1	Shank Dia. D4	No. of Flutes N	Stock	Type	Effective Length for Inclined Angle			
												30°	1°	2°	3°
VF2XLBR0010N005S04	0.1	0.2	0.16	0.5	11.2°	0.17	50	4	2	●	1	0.7	0.8	0.9	1.0
R0010N005S06	0.1	0.2	0.16	0.5	11.5°	0.17	50	6	2	●	1	0.7	0.8	0.9	1.0
R0010N008S04	0.1	0.2	0.16	0.75	10.9°	0.17	50	4	2	●	1	1.0	1.1	1.2	1.3
R0010N010S04	0.1	0.2	0.16	1	10.7°	0.17	50	4	2	●	1	1.3	1.3	1.5	1.6
R0010N010S06	0.1	0.2	0.16	1	11.1°	0.17	50	6	2	●	1	1.3	1.3	1.5	1.6
R0010N013S04	0.1	0.2	0.16	1.25	10.4°	0.17	50	4	2	●	1	1.5	1.6	1.8	1.9
R0010N015S04	0.1	0.2	0.16	1.5	10.2°	0.17	50	4	2	●	1	1.8	1.9	2.1	2.3
R0010N015S06	0.1	0.2	0.16	1.5	10.8°	0.17	50	6	2	●	1	1.8	1.9	2.1	2.3
R0010N018S04	0.1	0.2	0.16	1.75	10.0°	0.17	50	4	2	●	1	2.1	2.2	2.4	2.6
R0010N020S04	0.1	0.2	0.16	2	9.7°	0.17	50	4	2	●	1	2.3	2.4	2.7	2.9
R0010N025S04	0.1	0.2	0.16	2.5	9.3°	0.17	50	4	2	●	1	2.8	3.0	3.3	3.6
R0015N010S04	0.15	0.3	0.24	1	10.7°	0.27	50	4	2	●	1	1.3	1.3	1.5	1.6
R0015N010S06	0.15	0.3	0.24	1	11.1°	0.27	50	6	2	●	1	1.3	1.3	1.5	1.6
R0015N013S04	0.15	0.3	0.24	1.25	10.4°	0.27	50	4	2	●	1	1.5	1.6	1.8	1.9
R0015N015S04	0.15	0.3	0.24	1.5	10.2°	0.27	50	4	2	●	1	1.8	1.9	2.1	2.3
R0015N015S06	0.15	0.3	0.24	1.5	10.8°	0.27	50	6	2	●	1	1.8	1.9	2.1	2.3
R0015N018S04	0.15	0.3	0.24	1.75	10.0°	0.27	50	4	2	●	1	2.1	2.1	2.4	2.6
R0015N020S04	0.15	0.3	0.24	2	9.7°	0.27	50	4	2	●	1	2.3	2.4	2.7	2.9
R0015N020S06	0.15	0.3	0.24	2	10.4°	0.27	50	6	2	●	1	2.3	2.4	2.7	2.9
R0015N025S04	0.15	0.3	0.24	2.5	9.3°	0.27	50	4	2	●	1	2.8	3.0	3.2	3.6
R0015N030S04	0.15	0.3	0.24	3	8.9°	0.27	50	4	2	●	1	3.4	3.5	3.8	4.3
R0015N040S04	0.15	0.3	0.24	4	8.2°	0.27	50	4	2	●	1	4.4	4.6	5.0	5.6
R0020N010S04	0.2	0.4	0.32	1	10.7°	0.36	50	4	2	●	1	1.3	1.4	1.5	1.6
R0020N010S06	0.2	0.4	0.32	1	11.1°	0.36	50	6	2	●	1	1.3	1.4	1.5	1.6
R0020N015S04	0.2	0.4	0.32	1.5	10.2°	0.36	50	4	2	●	1	1.8	1.9	2.1	2.3
R0020N015S06	0.2	0.4	0.32	1.5	10.8°	0.36	50	6	2	●	1	1.8	1.9	2.1	2.3
R0020N020S04	0.2	0.4	0.32	2	9.7°	0.36	50	4	2	●	1	2.3	2.4	2.7	2.9
R0020N020S06	0.2	0.4	0.32	2	10.4°	0.36	50	6	2	●	1	2.3	2.4	2.7	2.9
R0020N025S04	0.2	0.4	0.32	2.5	9.3°	0.36	50	4	2	●	1	2.9	3.0	3.3	3.6
R0020N025S06	0.2	0.4	0.32	2.5	10.1°	0.36	50	6	2	●	1	2.9	3.0	3.3	3.6
R0020N030S04	0.2	0.4	0.32	3	8.9°	0.36	50	4	2	●	1	3.4	3.5	3.9	4.3
R0020N030S06	0.2	0.4	0.32	3	9.8°	0.36	50	6	2	●	1	3.4	3.5	3.9	4.3
R0020N040S04	0.2	0.4	0.32	4	8.2°	0.36	50	4	2	●	1	4.4	4.6	5.1	5.6
R0020N050S04	0.2	0.4	0.32	5	7.6°	0.36	50	4	2	●	1	5.5	5.7	6.3	6.9
R0025N015S04	0.25	0.5	0.4	1.5	10.2°	0.46	50	4	2	●	1	1.8	1.9	2.1	2.3
R0025N015S06	0.25	0.5	0.4	1.5	10.8°	0.46	50	6	2	●	1	1.8	1.9	2.1	2.3
R0025N020S04	0.25	0.5	0.4	2	9.7°	0.46	50	4	2	●	1	2.3	2.4	2.7	2.9
R0025N020S06	0.25	0.5	0.4	2	10.4°	0.46	50	6	2	●	1	2.3	2.4	2.7	2.9

IMPACT MIRACLE END MILLS

VF-2XLB

Ball nose, Long cut length, 2 flute, For hardened materials



$R \leq 1 \pm 0.007$
 $1 < R \pm 0.010$



0 - -0.02



Effective length for inclined angle

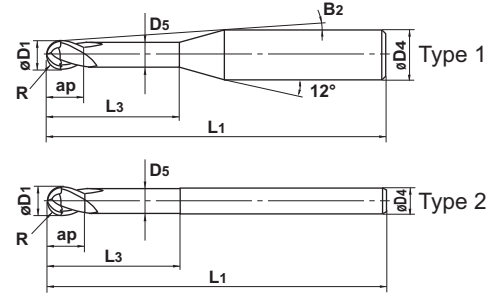
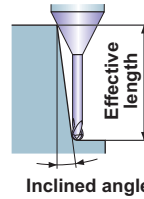

● 2 flute long neck ball nose end mill for high hardened materials.

Unit : mm

Order Number	Radius of Ball Nose R	Dia. D1	Length of Cut ap	Neck Length L3	Cutting Edge to Shank Angle B2	Neck Dia. D5	Overall Length L1	Shank Dia. D4	No. of Flutes N	Stock	Type	Effective Length for Inclined Angle			
												30°	1°	2°	3°
VF2XLBR0025N025S04	0.25	0.5	0.4	2.5	9.2°	0.46	50	4	2	●	1	2.9	3.0	3.3	3.6
R0025N030S04	0.25	0.5	0.4	3	8.8°	0.46	50	4	2	●	1	3.4	3.5	3.9	4.3
R0025N030S06	0.25	0.5	0.4	3	9.8°	0.46	50	6	2	●	1	3.4	3.5	3.9	4.3
R0025N035S04	0.25	0.5	0.4	3.5	8.5°	0.46	50	4	2	●	1	3.9	4.1	4.5	4.9
R0025N040S04	0.25	0.5	0.4	4	8.1°	0.46	50	4	2	●	1	4.4	4.6	5.1	5.6
R0025N040S06	0.25	0.5	0.4	4	9.2°	0.46	50	6	2	●	1	4.4	4.6	5.1	5.6
R0025N050S04	0.25	0.5	0.4	5	7.5°	0.46	50	4	2	●	1	5.5	5.7	6.2	6.9
R0025N050S06	0.25	0.5	0.4	5	8.7°	0.46	50	6	2	●	1	5.5	5.7	6.2	6.9
R0025N060S04	0.25	0.5	0.4	6	7.0°	0.46	50	4	2	●	1	6.5	6.8	7.4	8.2
R0025N060S06	0.25	0.5	0.4	6	8.3°	0.46	60	6	2	●	1	6.5	6.8	7.4	8.2
R0030N020S04	0.3	0.6	0.48	2	9.6°	0.56	50	4	2	●	1	2.4	2.5	2.8	3.1
R0030N020S06	0.3	0.6	0.48	2	10.4°	0.56	50	6	2	●	1	2.4	2.5	2.8	3.1
R0030N025S04	0.3	0.6	0.48	2.5	9.1°	0.56	50	4	2	●	1	3.0	3.1	3.4	3.7
R0030N030S04	0.3	0.6	0.48	3	8.7°	0.56	50	4	2	●	1	3.5	3.6	4.0	4.4
R0030N030S06	0.3	0.6	0.48	3	9.7°	0.56	50	6	2	●	1	3.5	3.6	4.0	4.4
R0030N035S04	0.3	0.6	0.48	3.5	8.4°	0.56	50	4	2	●	1	4.0	4.2	4.6	5.0
R0030N040S04	0.3	0.6	0.48	4	8.0°	0.56	50	4	2	●	1	4.5	4.7	5.2	5.7
R0030N040S06	0.3	0.6	0.48	4	9.2°	0.56	50	6	2	●	1	4.5	4.7	5.2	5.7
R0030N050S04	0.3	0.6	0.48	5	7.4°	0.56	50	4	2	●	1	5.6	5.8	6.4	7.0
R0030N050S06	0.3	0.6	0.48	5	8.7°	0.56	50	6	2	●	1	5.6	5.8	6.4	7.0
R0030N060S04	0.3	0.6	0.48	6	6.9°	0.56	50	4	2	●	1	6.6	6.9	7.6	8.4
R0030N060S06	0.3	0.6	0.48	6	8.2°	0.56	50	6	2	●	1	6.6	6.9	7.6	8.4
R0030N070S04	0.3	0.6	0.48	7	6.5°	0.56	50	4	2	●	1	7.7	8.0	8.8	9.7
R0030N080S04	0.3	0.6	0.48	8	6.1°	0.56	50	4	2	●	1	8.7	9.1	10.0	11.0
R0030N080S06	0.3	0.6	0.48	8	7.4°	0.56	60	6	2	●	1	8.7	9.1	10.0	11.0
R0040N020S04	0.4	0.8	0.64	2	9.5°	0.76	50	4	2	●	1	2.4	2.5	2.8	3.0
R0040N020S06	0.4	0.8	0.64	2	10.4°	0.76	50	6	2	●	1	2.4	2.5	2.8	3.0
R0040N030S04	0.4	0.8	0.64	3	8.7°	0.76	50	4	2	●	1	3.5	3.6	4.0	4.3
R0040N030S06	0.4	0.8	0.64	3	9.7°	0.76	50	6	2	●	1	3.5	3.6	4.0	4.3
R0040N040S04	0.4	0.8	0.64	4	7.9°	0.76	50	4	2	●	1	4.5	4.7	5.1	5.7
R0040N040S06	0.4	0.8	0.64	4	9.1°	0.76	50	6	2	●	1	4.5	4.7	5.1	5.7
R0040N050S04	0.4	0.8	0.64	5	7.3°	0.76	50	4	2	●	1	5.6	5.8	6.3	7.0
R0040N060S04	0.4	0.8	0.64	6	6.8°	0.76	50	4	2	●	1	6.6	6.9	7.5	8.3
R0040N060S06	0.4	0.8	0.64	6	8.1°	0.76	50	6	2	●	1	6.6	6.9	7.5	8.3
R0040N070S04	0.4	0.8	0.64	7	6.3°	0.76	50	4	2	●	1	7.7	8.0	8.7	9.7
R0040N080S04	0.4	0.8	0.64	8	5.9°	0.76	50	4	2	●	1	8.7	9.1	9.9	11.0
R0040N080S06	0.4	0.8	0.64	8	7.4°	0.76	50	6	2	●	1	8.7	9.1	9.9	11.0
R0040N100S04	0.4	0.8	0.64	10	5.3°	0.76	50	4	2	●	1	10.8	11.3	12.3	13.6

Order Number	Radius of Ball Nose R	Radius of Ball Nose D1	Length of Cut ap	Neck Length L3	Cutting Edge to Shank Angle B2	Neck Dia. D5	Overall Length L1	Shank Dia. D4	No. of Flutes N	Stock	Type	Effective Length for Inclined Angle			
												30°	1°	2°	3°
VF2XLBR0040N100S06	0.4	0.8	0.64	10	6.7°	0.76	60	6	2	●	1	10.8	11.3	12.3	13.6
R0050N030S04	0.5	1	0.8	3	8.3°	0.94	50	4	2	●	1	3.8	4.0	4.4	4.8
R0050N030S06	0.5	1	0.8	3	9.5°	0.94	50	6	2	●	1	3.8	4.0	4.4	4.8
R0050N040S04	0.5	1	0.8	4	7.6°	0.94	50	4	2	●	1	4.9	5.1	5.6	6.1
R0050N040S06	0.5	1	0.8	4	8.9°	0.94	50	6	2	●	1	4.9	5.1	5.6	6.1
R0050N050S04	0.5	1	0.8	5	7.0°	0.94	50	4	2	●	1	5.9	6.2	6.8	7.5
R0050N050S06	0.5	1	0.8	5	8.4°	0.94	50	6	2	●	1	5.9	6.2	6.8	7.5
R0050N060S04	0.5	1	0.8	6	6.5°	0.94	50	4	2	●	1	7.0	7.3	8.0	8.8
R0050N060S06	0.5	1	0.8	6	7.9°	0.94	50	6	2	●	1	7.0	7.3	8.0	8.8
R0050N070S04	0.5	1	0.8	7	6.0°	0.94	50	4	2	●	1	8.0	8.4	9.2	10.1
R0050N080S04	0.5	1	0.8	8	5.6°	0.94	50	4	2	●	1	9.1	9.5	10.3	11.4
R0050N080S06	0.5	1	0.8	8	7.2°	0.94	50	6	2	●	1	9.1	9.5	10.3	11.4
R0050N090S04	0.5	1	0.8	9	5.3°	0.94	50	4	2	●	1	10.1	10.6	11.5	12.8
R0050N100S04	0.5	1	0.8	10	5.0°	0.94	50	4	2	●	1	11.2	11.6	12.7	14.1
R0050N100S06	0.5	1	0.8	10	6.5°	0.94	50	6	2	●	1	11.2	11.6	12.7	14.1
R0050N120S04	0.5	1	0.8	12	4.5°	0.94	50	4	2	●	1	13.2	13.8	15.1	16.7
R0050N120S06	0.5	1	0.8	12	6.0°	0.94	60	6	2	●	1	13.2	13.8	15.1	16.7
R0050N140S04	0.5	1	0.8	14	4.1°	0.94	60	4	2	●	1	15.3	16.0	17.5	19.4
R0050N160S04	0.5	1	0.8	16	3.7°	0.94	60	4	2	●	1	17.4	18.2	19.9	22.1
R0050N160S06	0.5	1	0.8	16	5.1°	0.94	70	6	2	●	1	17.4	18.2	19.9	22.1
R0050N180S04	0.5	1	0.8	18	3.4°	0.94	60	4	2	●	1	19.5	20.4	22.3	24.7
R0050N200S04	0.5	1	0.8	20	3.2°	0.94	60	4	2	●	1	21.6	22.5	24.7	27.4
R0050N200S06	0.5	1	0.8	20	4.5°	0.94	70	6	2	●	1	21.6	22.5	24.7	27.4
R0060N060S04	0.6	1.2	0.96	6	6.3°	1.14	50	4	2	●	1	7.0	7.3	7.9	8.7
R0060N060S06	0.6	1.2	0.96	6	7.9°	1.14	50	6	2	●	1	7.0	7.3	7.9	8.7
R0060N080S04	0.6	1.2	0.96	8	5.5°	1.14	50	4	2	●	1	9.1	9.5	10.3	11.4
R0060N080S06	0.6	1.2	0.96	8	7.1°	1.14	50	6	2	●	1	9.1	9.5	10.3	11.4
R0060N100S04	0.6	1.2	0.96	10	4.8°	1.14	50	4	2	●	1	11.2	11.6	12.7	14.1
R0060N100S06	0.6	1.2	0.96	10	6.4°	1.14	50	6	2	●	1	11.2	11.6	12.7	14.1
R0060N120S04	0.6	1.2	0.96	12	4.3°	1.14	50	4	2	●	1	13.2	13.8	15.1	16.7
R0060N120S06	0.6	1.2	0.96	12	5.9°	1.14	50	6	2	●	1	13.2	13.8	15.1	16.7
R0060N140S04	0.6	1.2	0.96	14	3.9°	1.14	60	4	2	●	1	15.3	16.0	17.5	19.4
R0060N160S04	0.6	1.2	0.96	16	3.6°	1.14	60	4	2	●	1	17.4	18.2	19.9	22.0
R0060N160S06	0.6	1.2	0.96	16	5.0°	1.14	70	6	2	●	1	17.4	18.2	19.9	22.0
R0070N080S04	0.7	1.4	1.12	8	5.3°	1.34	50	4	2	●	1	9.1	9.4	10.3	11.4
R0070N120S04	0.7	1.4	1.12	12	4.1°	1.34	50	4	2	●	1	13.2	13.8	15.1	16.7
R0070N160S04	0.7	1.4	1.12	16	3.4°	1.34	60	4	2	●	1	17.4	18.2	19.9	22.0
R0075N060S04	0.75	1.5	1.2	6	6.0°	1.44	50	4	2	●	1	7.0	7.3	7.9	8.7
R0075N060S06	0.75	1.5	1.2	6	7.7°	1.44	50	6	2	●	1	7.0	7.3	7.9	8.7
R0075N080S04	0.75	1.5	1.2	8	5.2°	1.44	50	4	2	●	1	9.1	9.4	10.3	11.4
R0075N080S06	0.75	1.5	1.2	8	6.9°	1.44	50	6	2	●	1	9.1	9.4	10.3	11.4
R0075N100S04	0.75	1.5	1.2	10	4.5°	1.44	50	4	2	●	1	11.1	11.6	12.7	14.0
R0075N100S06	0.75	1.5	1.2	10	6.3°	1.44	50	6	2	●	1	11.1	11.6	12.7	14.0
R0075N120S04	0.75	1.5	1.2	12	4.0°	1.44	50	4	2	●	1	13.2	13.8	15.1	16.7
R0075N120S06	0.75	1.5	1.2	12	5.7°	1.44	50	6	2	●	1	13.2	13.8	15.1	16.7
R0075N140S04	0.75	1.5	1.2	14	3.6°	1.44	50	4	2	●	1	15.3	16.0	17.5	19.3
R0075N140S06	0.75	1.5	1.2	14	5.3°	1.44	50	6	2	●	1	15.3	16.0	17.5	19.3
R0075N160S04	0.75	1.5	1.2	16	3.3°	1.44	60	4	2	●	1	17.4	18.2	19.9	22.0

IMPACT MIRACLE END MILLS

VF-2XLB

Ball nose, Long cut length, 2 flute, For hardened materials



$R \leq 1 \pm 0.007$
 $1 < R \pm 0.010$



$0 - -0.02$



Effective length
for inclined angle

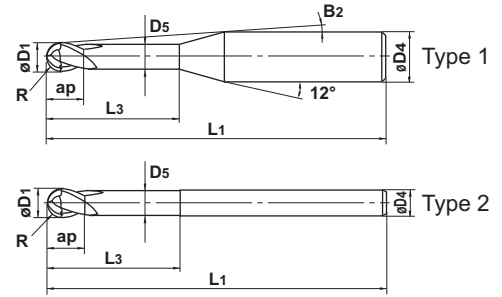
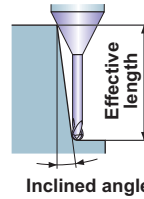

- 2 flute long neck ball nose end mill for high hardened materials.

Unit : mm

Order Number	Radius of Ball Nose R	Dia. D1	Length of Cut ap	Neck Length L3	Cutting Edge to Shank Angle B2	Neck Dia. D5	Overall Length L1	Shank Dia. D4	No. of Flutes N	Stock	Type	Effective Length for Inclined Angle			
												30°	1°	2°	3°
VF2XLBR0075N160S06	0.75	1.5	1.2	16	4.9°	1.44	60	6	2	●	1	17.4	18.2	19.9	22.0
R0075N180S04	0.75	1.5	1.2	18	3.0°	1.44	60	4	2	●	1	19.5	20.3	22.3	24.6
R0075N200S04	0.75	1.5	1.2	20	2.8°	1.44	60	4	2	●	1	21.6	22.5	24.7	No interference
R0075N200S06	0.75	1.5	1.2	20	4.3°	1.44	70	6	2	●	1	21.6	22.5	24.7	27.3
R0080N080S04	0.8	1.6	1.28	8	5.1°	1.54	50	4	2	●	1	9.1	9.4	10.3	11.3
R0080N120S04	0.8	1.6	1.28	12	3.9°	1.54	50	4	2	●	1	13.2	13.8	15.1	16.6
R0080N160S04	0.8	1.6	1.28	16	3.2°	1.54	60	4	2	●	1	17.4	18.2	19.9	22.0
R0080N200S04	0.8	1.6	1.28	20	2.7°	1.54	60	4	2	●	1	21.6	22.5	24.7	No interference
R0090N080S04	0.9	1.8	1.44	8	4.9°	1.74	50	4	2	●	1	9.0	9.4	10.3	11.3
R0090N120S04	0.9	1.8	1.44	12	3.7°	1.74	50	4	2	●	1	13.2	13.8	15.1	16.6
R0090N160S04	0.9	1.8	1.44	16	3.0°	1.74	60	4	2	●	1	17.4	18.1	19.8	No interference
R0090N200S04	0.9	1.8	1.44	20	2.6°	1.74	60	4	2	●	1	21.6	22.5	24.6	No interference
R0100N060S04	1	2	1.6	6	5.4°	1.9	50	4	2	●	1	7.1	7.3	8.0	8.7
R0100N060S06	1	2	1.6	6	7.5°	1.9	50	6	2	●	1	7.1	7.3	8.0	8.7
R0100N080S04	1	2	1.6	8	4.6°	1.9	50	4	2	●	1	9.2	9.5	10.4	11.4
R0100N080S06	1	2	1.6	8	6.6°	1.9	50	6	2	●	1	9.2	9.5	10.4	11.4
R0100N100S04	1	2	1.6	10	4.0°	1.9	50	4	2	●	1	11.2	11.7	12.8	14.1
R0100N100S06	1	2	1.6	10	6.0°	1.9	50	6	2	●	1	11.2	11.7	12.8	14.1
R0100N120S04	1	2	1.6	12	3.5°	1.9	50	4	2	●	1	13.3	13.9	15.2	16.7
R0100N120S06	1	2	1.6	12	5.4°	1.9	50	6	2	●	1	13.3	13.9	15.2	16.7
R0100N140S04	1	2	1.6	14	3.1°	1.9	50	4	2	●	1	15.4	16.1	17.5	19.4
R0100N140S06	1	2	1.6	14	5.0°	1.9	50	6	2	●	1	15.4	16.1	17.5	19.4
R0100N160S04	1	2	1.6	16	2.8°	1.9	60	4	2	●	1	17.5	18.2	19.9	No interference
R0100N160S06	1	2	1.6	16	4.6°	1.9	60	6	2	●	1	17.5	18.2	19.9	22.0
R0100N180S04	1	2	1.6	18	2.6°	1.9	60	4	2	●	1	19.6	20.4	22.3	No interference
R0100N180S06	1	2	1.6	18	4.2°	1.9	60	6	2	●	1	19.6	20.4	22.3	24.7
R0100N200S04	1	2	1.6	20	2.4°	1.9	60	4	2	●	1	21.7	22.6	24.7	No interference
R0100N200S06	1	2	1.6	20	4.0°	1.9	60	6	2	●	1	21.7	22.6	24.7	27.3
R0100N220S04	1	2	1.6	22	2.2°	1.9	60	4	2	●	1	23.8	24.8	27.1	No interference
R0100N250S04	1	2	1.6	25	2.0°	1.9	70	4	2	●	1	26.9	28.0	No interference	No interference
R0100N250S06	1	2	1.6	25	3.4°	1.9	70	6	2	●	1	26.9	28.0	30.7	34.0
R0100N300S04	1	2	1.6	30	1.7°	1.9	70	4	2	●	1	32.1	33.5	No interference	No interference
R0100N300S06	1	2	1.6	30	3.0°	1.9	80	6	2	●	1	32.1	33.5	36.7	No interference
R0100N350S04	1	2	1.6	35	1.5°	1.9	80	4	2	●	1	37.3	38.9	No interference	No interference
R0125N100S06	1.25	2.5	2	10	5.6°	2.4	60	6	2	●	1	11.2	11.7	12.7	14.0
R0125N150S06	1.25	2.5	2	15	4.4°	2.4	60	6	2	●	1	16.4	17.1	18.7	20.6
R0125N200S06	1.25	2.5	2	20	3.6°	2.4	70	6	2	●	1	21.7	22.6	24.7	27.2
R0125N250S06	1.25	2.5	2	25	3.1°	2.4	70	6	2	●	1	26.9	28.0	30.7	33.9

Order Number	Radius of Ball Nose R	Dia. D1	Length of Cut ap	Neck Length L3	Cutting Edge to Shank Angle B2	Neck Dia. D5	Overall Length L1	Shank Dia. D4	No. of Flutes N	Stock	Type	Effective Length for Inclined Angle			
												30°	1°	2°	3°
VF2XLBR0125N300S06	1.25	2.5	2	30	2.7°	2.4	80	6	2	●	1	32.1	33.5	36.6	No interference
R0125N350S06	1.25	2.5	2	35	2.4°	2.4	80	6	2	●	1	37.3	38.9	42.6	No interference
R0150N080S06	1.5	3	2.4	8	6.0°	2.9	60	6	2	●	1	9.1	9.5	10.3	11.2
R0150N100S06	1.5	3	2.4	10	5.2°	2.9	60	6	2	●	1	11.2	11.7	12.7	13.9
R0150N120S06	1.5	3	2.4	12	4.7°	2.9	60	6	2	●	1	13.3	13.8	15.1	16.5
R0150N140S06	1.5	3	2.4	14	4.2°	2.9	60	6	2	●	1	15.4	16.0	17.4	19.2
R0150N160S06	1.5	3	2.4	16	3.9°	2.9	60	6	2	●	1	17.5	18.2	19.8	21.9
R0150N200S06	1.5	3	2.4	20	3.3°	2.9	70	6	2	●	1	21.6	22.5	24.6	27.2
R0150N250S06	1.5	3	2.4	25	2.8°	2.9	70	6	2	●	1	26.9	28.0	30.6	No interference
R0150N300S06	1.5	3	2.4	30	2.4°	2.9	70	6	2	●	1	32.1	33.4	36.6	No interference
R0150N350S06	1.5	3	2.4	35	2.1°	2.9	80	6	2	●	1	37.3	38.9	42.6	No interference
R0150N400S06	1.5	3	2.4	40	1.9°	2.9	90	6	2	●	1	42.5	44.3	No interference	No interference
R0175N160S06	1.75	3.5	2.8	16	3.4°	3.4	60	6	2	●	1	17.5	18.2	19.8	21.8
R0175N200S06	1.75	3.5	2.8	20	2.9°	3.4	70	6	2	●	1	21.6	22.5	24.6	No interference
R0175N250S06	1.75	3.5	2.8	25	2.4°	3.4	70	6	2	●	1	26.8	28.0	30.6	No interference
R0175N300S06	1.75	3.5	2.8	30	2.1°	3.4	80	6	2	●	1	32.1	33.4	36.5	No interference
R0175N350S06	1.75	3.5	2.8	35	1.8°	3.4	80	6	2	●	1	37.3	38.9	No interference	No interference
R0175N400S06	1.75	3.5	2.8	40	1.6°	3.4	90	6	2	●	1	42.5	44.3	No interference	No interference
R0200N100S06	2	4	3.2	10	4.2°	3.9	70	6	2	●	1	11.2	11.6	12.6	13.7
R0200N120S06	2	4	3.2	12	3.7°	3.9	70	6	2	●	1	13.3	13.8	15.0	16.4
R0200N140S06	2	4	3.2	14	3.3°	3.9	70	6	2	●	1	15.4	16.0	17.4	19.0
R0200N160S06	2	4	3.2	16	3.0°	3.9	70	6	2	●	1	17.5	18.1	19.7	No interference
R0200N200S06	2	4	3.2	20	2.5°	3.9	70	6	2	●	1	21.6	22.5	24.5	No interference
R0200N250S06	2	4	3.2	25	2.1°	3.9	70	6	2	●	1	26.8	28.0	30.5	No interference
R0200N300S06	2	4	3.2	30	1.8°	3.9	70	6	2	●	1	32.1	33.4	No interference	No interference
R0200N350S06	2	4	3.2	35	1.5°	3.9	80	6	2	●	1	37.3	38.8	No interference	No interference
R0200N400S06	2	4	3.2	40	1.4°	3.9	90	6	2	●	1	42.5	44.3	No interference	No interference
R0200N450S06	2	4	3.2	45	1.2°	3.9	90	6	2	●	1	47.7	49.7	No interference	No interference
R0200N500S06	2	4	3.2	50	1.1°	3.9	100	6	2	●	1	52.9	55.2	No interference	No interference
R0250N200S06	2.5	5	4	20	1.4°	4.9	70	6	2	●	1	21.6	22.5	No interference	No interference
R0250N250S06	2.5	5	4	25	1.2°	4.9	70	6	2	●	1	26.8	27.9	No interference	No interference
R0250N300S06	2.5	5	4	30	1.0°	4.9	80	6	2	●	1	32.0	No interference	No interference	No interference
R0250N350S06	2.5	5	4	35	0.9°	4.9	80	6	2	●	1	37.2	No interference	No interference	No interference
R0300N300S06	3	6	4.8	30	0.0°	5.85	80	6	2	●	2	No interference	No interference	No interference	No interference
R0300N400S06	3	6	4.8	40	0.0°	5.85	90	6	2	●	2	No interference	No interference	No interference	No interference
R0300N500S06	3	6	4.8	50	0.0°	5.85	100	6	2	●	2	No interference	No interference	No interference	No interference

IMPACT MIRACLE 2 FLUTE LONG NECK BALL NOSE END MILL SERIES

Work Material		Hardened Steel (40—55HRC) NAK, JIS SKD61, STAVAX			Hardened Steel (55—62HRC) JIS SKD11, HSS		
R (mm)	Neck Length (mm)	Revolution (min ⁻¹)	Feed Rate (mm/min)	Depth of Cut ap (mm)	Revolution (min ⁻¹)	Feed Rate (mm/min)	Depth of Cut ap (mm)
R 0.1	0.5	40,000	300	0.003	40,000	300	0.002
	1	40,000	300	0.002	40,000	300	0.002
	1.5	40,000	300	0.001	40,000	200	0.001
	2	40,000	200	0.001	40,000	100	0.001
	2.5	40,000	100	0.001	40,000	60	0.001
R 0.15	1	40,000	500	0.007	40,000	500	0.005
	1.5	40,000	500	0.005	40,000	500	0.003
	2	40,000	500	0.003	40,000	500	0.002
	2.5	40,000	400	0.003	40,000	400	0.002
	3	40,000	300	0.002	40,000	300	0.001
R 0.2	4	30,000	200	0.002	30,000	200	0.001
	1	40,000	1,400	0.015	40,000	1,400	0.01
	1.5	40,000	1,000	0.01	40,000	1,000	0.006
	2	40,000	1,000	0.01	40,000	1,000	0.006
	2.5	40,000	700	0.005	40,000	700	0.003
R 0.25	3	40,000	700	0.005	40,000	700	0.003
	4	40,000	600	0.004	40,000	500	0.003
	5	40,000	400	0.003	40,000	300	0.002
	1.5	40,000	2,000	0.02	40,000	2,000	0.015
	2	40,000	2,000	0.02	40,000	2,000	0.015
R 0.3	3	40,000	1,200	0.015	40,000	1,200	0.01
	4	36,000	900	0.01	36,000	900	0.007
	5	36,000	700	0.007	36,000	600	0.005
	6	36,000	600	0.006	36,000	500	0.004
	2	40,000	2,800	0.03	40,000	2,800	0.02
R 0.4	3	40,000	2,800	0.03	40,000	2,800	0.02
	4	35,000	2,000	0.02	35,000	2,000	0.015
	5	30,000	1,000	0.01	30,000	1,000	0.007
	6	30,000	800	0.008	30,000	800	0.005
	7	30,000	600	0.008	30,000	600	0.005
R 0.5	8	25,000	400	0.006	25,000	400	0.004
	2	40,000	3,500	0.04	40,000	3,500	0.03
	3	40,000	3,000	0.04	40,000	3,000	0.03
	4	40,000	3,000	0.02	40,000	3,000	0.015
	6	30,000	1,600	0.02	30,000	1,600	0.01
R 0.6	8	25,000	1,000	0.01	25,000	1,000	0.007
	10	25,000	600	0.008	25,000	600	0.005
	3	40,000	4,000	0.05	40,000	4,000	0.04
	4	40,000	4,000	0.05	40,000	4,000	0.04
	5	40,000	3,000	0.03	40,000	3,000	0.02
R 0.7	6	35,000	2,000	0.03	35,000	2,000	0.02
	8	30,000	1,600	0.02	30,000	1,600	0.01
	10	20,000	1,000	0.01	20,000	1,000	0.01
	12	20,000	1,000	0.01	18,000	800	0.008
	14	18,000	600	0.008	18,000	480	0.006
R 0.8	16	18,000	500	0.008	18,000	400	0.006
	18	13,000	300	0.005	13,000	240	0.004
	20	13,000	250	0.005	13,000	200	0.004
	6	40,000	4,000	0.05	35,000	3,500	0.04
	8	40,000	3,000	0.05	27,000	2,000	0.04
R 0.9	10	27,000	1,900	0.03	24,000	1,700	0.02
	12	16,000	1,100	0.02	16,000	1,000	0.01
	14	16,000	850	0.01	16,000	780	0.01
	16	15,000	500	0.01	14,000	400	0.006
	8	40,000	4,500	0.06	28,000	3,200	0.05
R 1.0	12	32,000	3,000	0.03	19,000	1,800	0.02
	16	15,000	1,000	0.02	14,000	800	0.01
	6	40,000	5,000	0.07	32,000	4,000	0.06
	8	40,000	5,000	0.07	28,000	3,500	0.06
	10	40,000	4,500	0.06	21,000	2,400	0.04
R 1.25	12	32,000	3,400	0.04	19,000	2,000	0.03
	14	16,000	1,500	0.04	13,000	1,200	0.03
	16	13,000	1,200	0.03	13,000	1,200	0.02
	18	13,000	1,200	0.03	13,000	1,200	0.02
	20	13,000	1,200	0.03	13,000	1,200	0.02

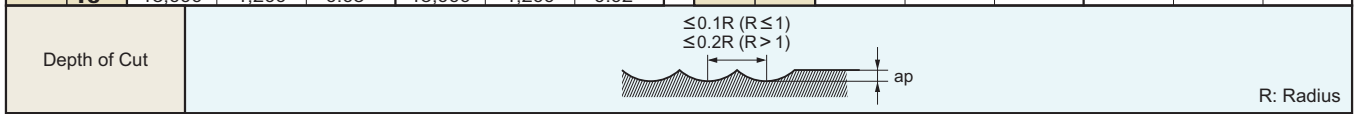

- 1) If the inclination of machining surface is very big, or cutting load is big, please reduce the revolution and the feed rate proportionately.
- 2) If using the small size, we recommend coolant mist.
- 3) If the depth of cut is shallow, the feed rate can be increased.

For Your Safety

- Don't handle inserts and chips without gloves.
- Please machine within the recommended application range and exchange expired tools with new ones in advance of breakage.
- Please use safety covers and wear safety glasses.
- When using compounded cutting oils, please take fire precautions.
- When using rotating tools, please make a trial run to check run-out, vibration and abnormal sounds etc.

MITSUBISHI MATERIALS CORPORATION



MITSUBISHI MATERIALS CORPORATION Area Marketing & Operations Dept.

KFC bldg., 8F, 1-6-1, Yokoami, Sumida-ku, Tokyo 130-0015, Japan
TEL +81-3-5819-8772 FAX +81-3-5819-8774

MITSUBISHI MATERIALS U.S.A. CORPORATION Headquarters

17401, Eastman Street, Irvine, California, 92614, USA
TEL +1-949-862-5100 FAX +1-949-862-5180

MMC HARTMETALL GmbH

Comeniusstr.2, 40670, Meerbusch GERMANY
TEL +49-2159-9189-0 FAX +49-2159-918966

MMC METAL SINGAPORE PTE LTD.

10, Arumugam Road, #04-00 Lion Industrial Bldg., 409957, SINGAPORE
TEL +65-6743-9370 FAX +65-6749-1469

Mitsubishi Carbide Home page : <http://www.mitsubishicarbide.com>
(Tools specifications subject to change without notice.)