

MSTAR END MILL SERIES

MS2XL MS4LT

364 **FULL ITEM** **SIZE**

Newly developed long neck and taper end mills for rib processing.

Wide variation of neck length and taper angle.



MSTAR End Mill Series

MS2XL

2 flute Mstar long neck end mill

MS4LT

4 flute Mstar for rib processing taper neck end mill

364 SIZE

FULL
ITEM

Wide variation of
neck length and
taper angle.

Newly developed long neck and taper end mills for rib processing.

■ Features

- High performance and long tool life due to "MS Coating" which adapts MIRACLE coating technology

MS2XL

2 flute Mstar long neck end mill

φ0.2—6mm 119 size

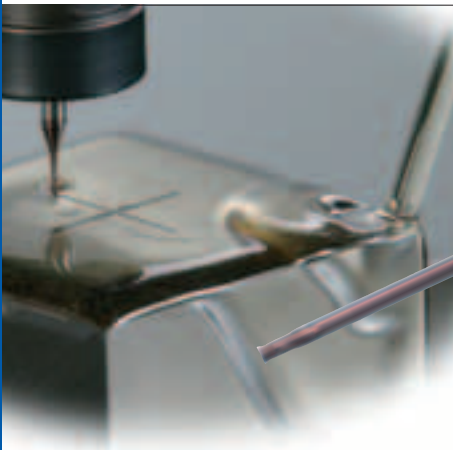

- 2 flute long neck end mill with neck relieved. Suitable for straight rib slotting, deep milling or milling near by vertical wall.

MS4LT

4 flute Mstar for rib processing taper neck end mill

φ0.2—3mm 245 size

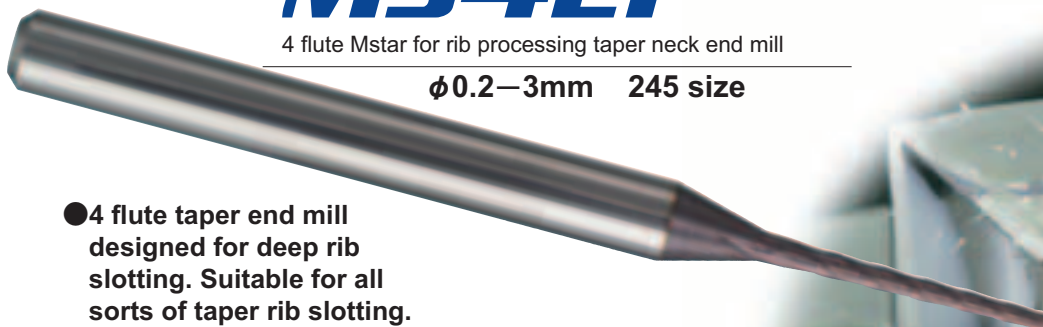

- 4 flute taper end mill designed for deep rib slotting. Suitable for all sorts of taper rib slotting.

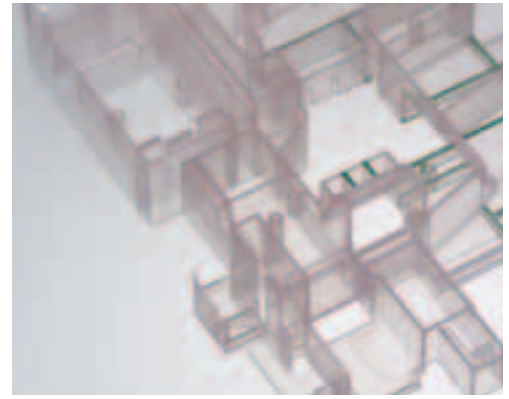
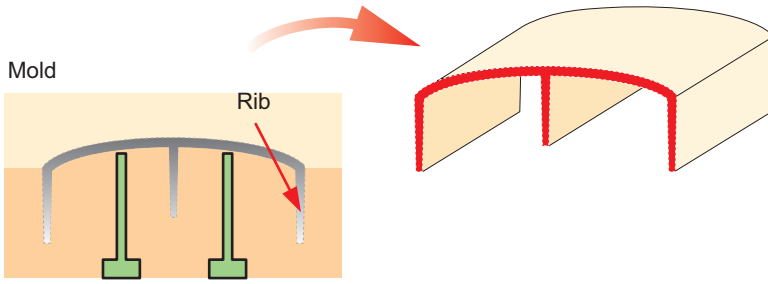

Machining example

Cutting Performance of MS2XL

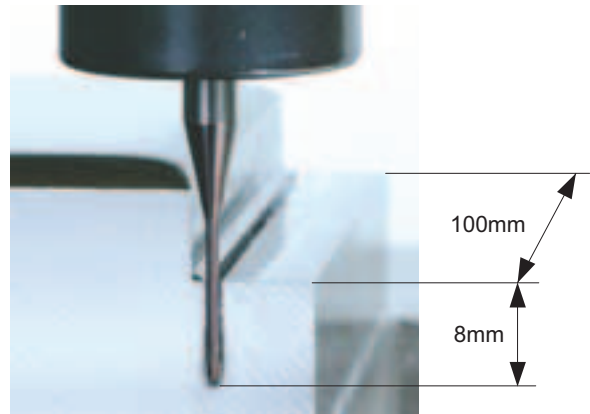
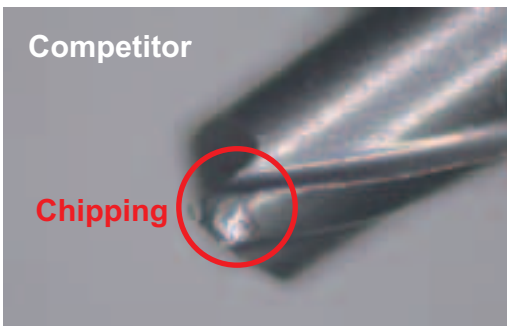
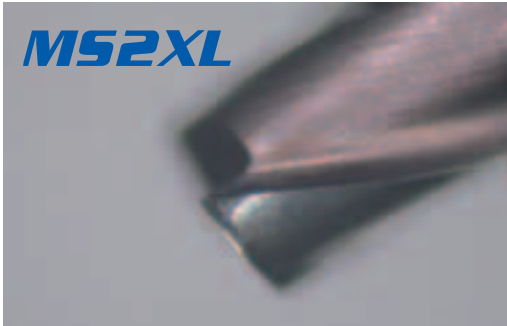

Cutting conditions

End mill	MS2XL $\phi 1 \times 12$
Work material	NAK80 (38HRC)
Revolution	20,000min ⁻¹ (62m/min)
Feed rate	500mm/min (0.01mm/tooth)
Depth of cut	0.02mm×400 times (Slotting)
Cutting method	Oil

Cutting Performance of MS4LT

[Results]

Competitor's end mill could not process even 1pcs because of the fracture.

MSTAR end mill "MS4LT" processes 1pcs and the damage of the cutting edge was much smaller. In addition, **MS4LT** could process this work piece at **2,000mm/min feed rate**.

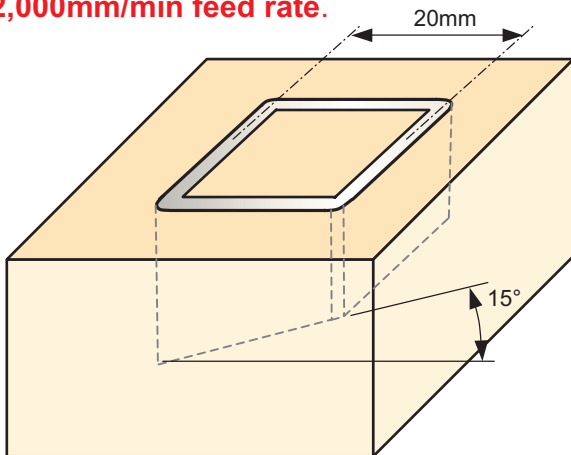

Slant & Blind Rib slot

Cutting conditions

End mill	MS4LT $\phi 2 \times 1^\circ \times 25$
Work material	NAK80 (38HRC)
Revolution	10,000min ⁻¹ (63m/min)
Feed rate	1,000mm/min (0.1mm/rev.)
Depth of cut	Ad 0.03mm×Max. 830 times (Slant rib slot · Max. depth 25mm)
Cutting method	Water-soluble oil

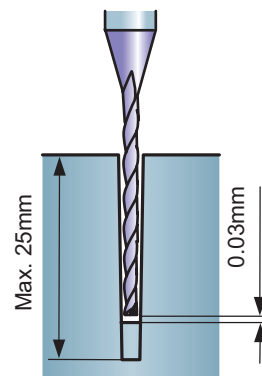

MSTAR END MILLS

MS2XL

2 flute Mstar long neck end mill



$D_1 < 0.5$ $0 - -0.01$
 $0.5 \leq D_1$ $0 - -0.02$

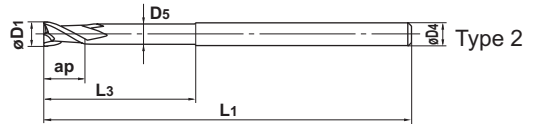
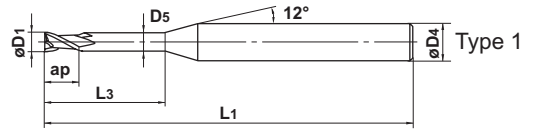

$D_1 < 0.4$



$0.4 \leq D_1$

● 2 flute long neck end mill for general purpose.

Unit : mm

Order Number	Dia. D1	Length of Cut ap	Neck Length L3	Neck Dia. D5	Overall Length L1	Shank Dia. D4	No. of Flute N	Stock	Type
MS2XLD0020N005	0.2	0.3	0.5	0.18	45	4	2	●	1
D0020N010	0.2	0.3	1	0.18	45	4	2	●	1
D0020N015	0.2	0.3	1.5	0.18	45	4	2	●	1
D0030N010	0.3	0.4	1	0.28	45	4	2	●	1
D0030N020	0.3	0.4	2	0.28	45	4	2	●	1
D0030N030	0.3	0.4	3	0.28	45	4	2	●	1
D0030N060	0.3	0.4	6	0.28	45	4	2	●	1
D0030N090	0.3	0.4	9	0.28	45	4	2	●	1
D0040N020	0.4	0.6	2	0.37	45	4	2	●	1
D0040N030	0.4	0.6	3	0.37	45	4	2	●	1
D0040N040	0.4	0.6	4	0.37	45	4	2	●	1
D0040N080	0.4	0.6	8	0.37	45	4	2	●	1
D0040N120	0.4	0.6	12	0.37	45	4	2	●	1
D0050N020	0.5	0.7	2	0.46	45	4	2	●	1
D0050N040	0.5	0.7	4	0.46	45	4	2	●	1
D0050N060	0.5	0.7	6	0.46	45	4	2	●	1
D0050N080	0.5	0.7	8	0.46	50	4	2	●	1
D0050N100	0.5	0.7	10	0.46	50	4	2	●	1
D0050N150	0.5	0.7	15	0.46	50	4	2	●	1
D0060N020	0.6	0.9	2	0.56	45	4	2	●	1
D0060N040	0.6	0.9	4	0.56	45	4	2	●	1
D0060N060	0.6	0.9	6	0.56	45	4	2	●	1
D0060N080	0.6	0.9	8	0.56	50	4	2	●	1
D0060N100	0.6	0.9	10	0.56	50	4	2	●	1
D0060N120	0.6	0.9	12	0.56	50	4	2	●	1
D0060N180	0.6	0.9	18	0.56	50	4	2	●	1
D0070N020	0.7	1	2	0.66	45	4	2	●	1
D0070N040	0.7	1	4	0.66	45	4	2	●	1
D0070N060	0.7	1	6	0.66	45	4	2	●	1
D0070N080	0.7	1	8	0.66	50	4	2	●	1
D0070N100	0.7	1	10	0.66	50	4	2	●	1
D0080N040	0.8	1.2	4	0.76	45	4	2	●	1
D0080N060	0.8	1.2	6	0.76	45	4	2	●	1
D0080N080	0.8	1.2	8	0.76	50	4	2	●	1
D0080N100	0.8	1.2	10	0.76	50	4	2	●	1
D0080N120	0.8	1.2	12	0.76	50	4	2	●	1
D0080N160	0.8	1.2	16	0.76	50	4	2	●	1
D0080N240	0.8	1.2	24	0.76	60	4	2	●	1

Unit : mm

Order Number	Dia. D1	Length of Cut ap	Neck Length L3	Neck Dia. D5	Overall Length L1	Shank Dia. D4	No. of Flute N	Stock	Type
MS2XLD0090N060	0.9	1.4	6	0.86	45	4	2	●	1
D0090N080	0.9	1.4	8	0.86	50	4	2	●	1
D0090N100	0.9	1.4	10	0.86	50	4	2	●	1
D0090N150	0.9	1.4	15	0.86	60	4	2	●	1
D0100N040	1	1.5	4	0.95	50	4	2	●	1
D0100N060	1	1.5	6	0.95	50	4	2	●	1
D0100N080	1	1.5	8	0.95	50	4	2	●	1
D0100N100	1	1.5	10	0.95	50	4	2	●	1
D0100N120	1	1.5	12	0.95	50	4	2	●	1
D0100N160	1	1.5	16	0.95	60	4	2	●	1
D0100N200	1	1.5	20	0.95	60	4	2	●	1
D0100N250	1	1.5	25	0.95	70	4	2	●	1
D0100N300	1	1.5	30	0.95	70	4	2	●	1
D0120N060	1.2	1.8	6	1.15	50	4	2	●	1
D0120N080	1.2	1.8	8	1.15	50	4	2	●	1
D0120N100	1.2	1.8	10	1.15	50	4	2	●	1
D0120N120	1.2	1.8	12	1.15	50	4	2	●	1
D0120N160	1.2	1.8	16	1.15	60	4	2	●	1
D0120N200	1.2	1.8	20	1.15	60	4	2	●	1
D0150N060	1.5	2.3	6	1.45	50	4	2	●	1
D0150N080	1.5	2.3	8	1.45	50	4	2	●	1
D0150N100	1.5	2.3	10	1.45	50	4	2	●	1
D0150N120	1.5	2.3	12	1.45	50	4	2	●	1
D0150N140	1.5	2.3	14	1.45	60	4	2	●	1
D0150N160	1.5	2.3	16	1.45	60	4	2	●	1
D0150N180	1.5	2.3	18	1.45	60	4	2	●	1
D0150N200	1.5	2.3	20	1.45	60	4	2	●	1
D0150N250	1.5	2.3	25	1.45	70	4	2	●	1
D0150N300	1.5	2.3	30	1.45	70	4	2	●	1
D0150N380	1.5	2.3	38	1.45	80	4	2	●	1
D0150N450	1.5	2.3	45	1.45	80	4	2	●	1
D0200N060	2	3	6	1.94	50	4	2	●	1
D0200N080	2	3	8	1.94	50	4	2	●	1
D0200N100	2	3	10	1.94	50	4	2	●	1
D0200N120	2	3	12	1.94	50	4	2	●	1
D0200N140	2	3	14	1.94	60	4	2	●	1
D0200N160	2	3	16	1.94	60	4	2	●	1
D0200N180	2	3	18	1.94	60	4	2	●	1
D0200N200	2	3	20	1.94	60	4	2	●	1
D0200N250	2	3	25	1.94	70	4	2	●	1
D0200N300	2	3	30	1.94	70	4	2	●	1
D0200N350	2	3	35	1.94	80	4	2	●	1
D0200N400	2	3	40	1.94	90	4	2	●	1
D0200N500	2	3	50	1.94	100	4	2	●	1
D0200N600	2	3	60	1.94	110	4	2	●	1
D0250N080	2.5	3.7	8	2.4	50	4	2	●	1
D0250N120	2.5	3.7	12	2.4	50	4	2	●	1
D0250N160	2.5	3.7	16	2.4	60	4	2	●	1

MSTAR END MILLS

MS2XL

2 flute Mstar long neck end mill



$D_1 < 0.5$ $0 - -0.01$
 $0.5 \leq D_1$ $0 - -0.02$

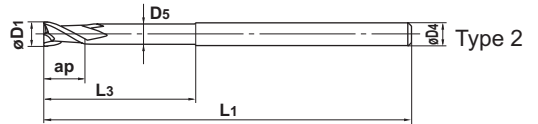
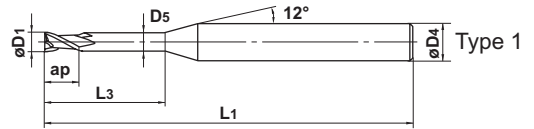

$D_1 < 0.4$



$0.4 \leq D_1$

● 2 flute long neck end mill for general purpose.

Unit : mm

Order Number	Dia. D1	Length of Cut ap	Neck Length L3	Neck Dia. D5	Overall Length L1	Shank Dia. D4	No. of Flute N	Stock	Type
MS2XLD0250N200	2.5	3.7	20	2.4	60	4	2	●	1
D0250N250	2.5	3.7	25	2.4	70	4	2	●	1
D0250N300	2.5	3.7	30	2.4	70	4	2	●	1
D0250N400	2.5	3.7	40	2.4	90	4	2	●	1
D0250N500	2.5	3.7	50	2.4	100	4	2	●	1
D0300N080	3	4.5	8	2.85	50	6	2	●	1
D0300N120	3	4.5	12	2.85	50	6	2	●	1
D0300N160	3	4.5	16	2.85	60	6	2	●	1
D0300N200	3	4.5	20	2.85	60	6	2	●	1
D0300N250	3	4.5	25	2.85	70	6	2	●	1
D0300N300	3	4.5	30	2.85	70	6	2	●	1
D0300N400	3	4.5	40	2.85	90	6	2	●	1
D0300N500	3	4.5	50	2.85	100	6	2	●	1
D0400N120	4	6	12	3.8	50	6	2	●	1
D0400N160	4	6	16	3.8	60	6	2	●	1
D0400N200	4	6	20	3.8	60	6	2	●	1
D0400N250	4	6	25	3.8	70	6	2	●	1
D0400N300	4	6	30	3.8	70	6	2	●	1
D0400N350	4	6	35	3.8	80	6	2	●	1
D0400N400	4	6	40	3.8	90	6	2	●	1
D0400N450	4	6	45	3.8	90	6	2	●	1
D0400N500	4	6	50	3.8	100	6	2	●	1
D0400N600	4	6	60	3.8	110	6	2	●	1
D0500N160	5	7.5	16	4.8	60	6	2	●	1
D0500N250	5	7.5	25	4.8	70	6	2	●	1
D0500N350	5	7.5	35	4.8	80	6	2	●	1
D0500N500	5	7.5	50	4.8	110	6	2	●	1
D0500N600	5	7.5	60	4.8	120	6	2	●	1
D0600N200	6	9	20	5.8	80	6	2	●	2
D0600N300	6	9	30	5.8	90	6	2	●	2
D0600N400	6	9	40	5.8	100	6	2	●	2
D0600N500	6	9	50	5.8	110	6	2	●	2
D0600N600	6	9	60	5.8	120	6	2	●	2

MS4LT

4 flute Mstar for rib processing taper neck end mill



$D1 < 0.5$ 0 - -0.02
 $0.5 \leq D1$ 0 - -0.04



$\pm 5'$

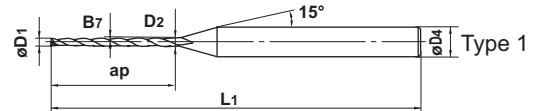

$D1 < 3$



$3 \leq D1$

● 4 flute Mstar for rib processing taper neck end mill for general purpose.

Unit : mm

Order Number	Small Mill Dia. D1	Taper Angle on Side B7	Large Mill Dia. D2	Length of Cut ap	Overall Length L1	Shank Dia. D4	No. of Flute N	Stock	Type
MS4LTD0020T0030L02	0.2	30'	0.23	2	40	3	4	●	1
D0020T0100L02	0.2	1°	0.27	2	40	3	4	●	1
D0020T0130L02	0.2	1° 30'	0.3	2	40	3	4	●	1
D0020T0200L02	0.2	2°	0.34	2	40	3	4	●	1
D0030T0030L03	0.3	30'	0.35	3	40	3	4	●	1
D0030T0100L03	0.3	1°	0.4	3	40	3	4	●	1
D0030T0130L03	0.3	1° 30'	0.46	3	40	3	4	●	1
D0030T0200L03	0.3	2°	0.51	3	40	3	4	●	1
D0040T0030L04	0.4	30'	0.47	4	40	3	4	●	1
D0040T0100L04	0.4	1°	0.54	4	40	3	4	●	1
D0040T0130L04	0.4	1° 30'	0.61	4	40	3	4	●	1
D0040T0200L04	0.4	2°	0.68	4	40	3	4	●	1
D0050T0030L04	0.5	30'	0.57	4	40	3	4	●	1
D0050T0030L06	0.5	30'	0.6	6	40	3	4	●	1
D0050T0100L04	0.5	1°	0.64	4	40	3	4	●	1
D0050T0100L06	0.5	1°	0.71	6	40	3	4	●	1
D0050T0130L04	0.5	1° 30'	0.71	4	40	3	4	●	1
D0050T0130L06	0.5	1° 30'	0.81	6	40	3	4	●	1
D0050T0200L04	0.5	2°	0.78	4	40	3	4	●	1
D0050T0200L06	0.5	2°	0.92	6	40	3	4	●	1
D0060T0030L04	0.6	30'	0.67	4	40	3	4	●	1
D0060T0030L06	0.6	30'	0.7	6	40	3	4	●	1
D0060T0100L04	0.6	1°	0.74	4	40	3	4	●	1
D0060T0100L06	0.6	1°	0.81	6	40	3	4	●	1
D0060T0130L04	0.6	1° 30'	0.81	4	40	3	4	●	1
D0060T0130L06	0.6	1° 30'	0.91	6	40	3	4	●	1
D0060T0200L04	0.6	2°	0.88	4	40	3	4	●	1
D0060T0200L06	0.6	2°	1.02	6	40	3	4	●	1
D0070T0030L06	0.7	30'	0.8	6	40	3	4	●	1
D0070T0030L08	0.7	30'	0.84	8	45	3	4	●	1
D0070T0100L06	0.7	1°	0.91	6	40	3	4	●	1
D0070T0100L08	0.7	1°	0.98	8	45	3	4	●	1
D0070T0130L06	0.7	1° 30'	1.01	6	40	3	4	●	1
D0070T0130L08	0.7	1° 30'	1.12	8	45	3	4	●	1
D0070T0200L06	0.7	2°	1.12	6	40	3	4	●	1
D0070T0200L08	0.7	2°	1.26	8	45	3	4	●	1
D0080T0015L04	0.8	15'	0.83	4	45	4	4	●	1
D0080T0015L06	0.8	15'	0.85	6	45	4	4	●	1

MSTAR END MILLS

MS4LT

4 flute Mstar for rib processing taper neck end mill



$D_1 < 0.5$ 0 - -0.02
 $0.5 \leq D_1$ 0 - -0.04



±5'

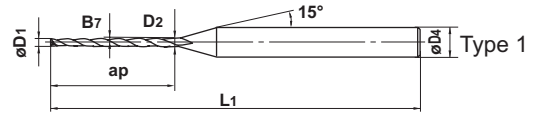

$D_1 < 3$

$3 \leq D_1$

● 4 flute Mstar for rib processing taper neck end mill for general purpose.

Unit : mm

Order Number	Small Mill Dia. D1	Taper Angle on Side B7	Large Mill Dia. D2	Length of Cut ap	Overall Length L1	Shank Dia. D4	No. of Flute N	Stock	Type
MS4LTD0080T0015L08	0.8	15'	0.87	8	45	4	4	●	1
D0080T0015L10	0.8	15'	0.89	10	45	4	4	●	1
D0080T0030L04	0.8	30'	0.87	4	45	4	4	●	1
D0080T0030L06	0.8	30'	0.9	6	45	4	4	●	1
D0080T0030L08	0.8	30'	0.94	8	45	4	4	●	1
D0080T0030L10	0.8	30'	0.97	10	45	4	4	●	1
D0080T0030L12	0.8	30'	1.01	12	50	4	4	●	1
D0080T0100L04	0.8	1°	0.94	4	45	4	4	●	1
D0080T0100L06	0.8	1°	1.01	6	45	4	4	●	1
D0080T0100L08	0.8	1°	1.08	8	45	4	4	●	1
D0080T0100L10	0.8	1°	1.15	10	45	4	4	●	1
D0080T0100L12	0.8	1°	1.22	12	50	4	4	●	1
D0080T0130L04	0.8	1° 30'	1.01	4	45	4	4	●	1
D0080T0130L06	0.8	1° 30'	1.11	6	45	4	4	●	1
D0080T0130L08	0.8	1° 30'	1.22	8	45	4	4	●	1
D0080T0130L10	0.8	1° 30'	1.32	10	45	4	4	●	1
D0080T0130L12	0.8	1° 30'	1.43	12	50	4	4	●	1
D0080T0200L04	0.8	2°	1.08	4	45	4	4	●	1
D0080T0200L06	0.8	2°	1.22	6	45	4	4	●	1
D0080T0200L08	0.8	2°	1.36	8	45	4	4	●	1
D0080T0200L10	0.8	2°	1.5	10	45	4	4	●	1
D0080T0200L12	0.8	2°	1.64	12	50	4	4	●	1
D0100T0015L06	1	15'	1.05	6	45	4	4	●	1
D0100T0015L08	1	15'	1.07	8	45	4	4	●	1
D0100T0015L10	1	15'	1.09	10	45	4	4	●	1
D0100T0015L12	1	15'	1.1	12	50	4	4	●	1
D0100T0030L06	1	30'	1.1	6	45	4	4	●	1
D0100T0030L08	1	30'	1.14	8	45	4	4	●	1
D0100T0030L10	1	30'	1.17	10	45	4	4	●	1
D0100T0030L12	1	30'	1.21	12	50	4	4	●	1
D0100T0100L06	1	1°	1.21	6	45	4	4	●	1
D0100T0100L08	1	1°	1.28	8	45	4	4	●	1
D0100T0100L10	1	1°	1.35	10	45	4	4	●	1
D0100T0100L12	1	1°	1.42	12	50	4	4	●	1
D0100T0100L16	1	1°	1.56	16	55	4	4	●	1
D0100T0130L06	1	1° 30'	1.31	6	45	4	4	●	1
D0100T0130L08	1	1° 30'	1.42	8	45	4	4	●	1
D0100T0130L10	1	1° 30'	1.52	10	45	4	4	●	1

Unit : mm

Order Number	Small Mill Dia. D1	Taper Angle on Side B7	Large Mill Dia. D2	Length of Cut ap	Overall Length L1	Shank Dia. D4	No. of Flute N	Stock	Type
MS4LTD0100T0130L12	1	1° 30'	1.63	12	50	4	4	●	1
D0100T0130L16	1	1° 30'	1.84	16	55	4	4	●	1
D0100T0200L06	1	2°	1.42	6	45	4	4	●	1
D0100T0200L08	1	2°	1.56	8	45	4	4	●	1
D0100T0200L10	1	2°	1.7	10	45	4	4	●	1
D0100T0200L12	1	2°	1.84	12	50	4	4	●	1
D0100T0200L16	1	2°	2.12	16	55	4	4	●	1
D0120T0015L06	1.2	15'	1.25	6	45	4	4	●	1
D0120T0015L10	1.2	15'	1.29	10	45	4	4	●	1
D0120T0015L12	1.2	15'	1.3	12	50	4	4	●	1
D0120T0015L16	1.2	15'	1.34	16	55	4	4	●	1
D0120T0030L06	1.2	30'	1.3	6	45	4	4	●	1
D0120T0030L10	1.2	30'	1.37	10	45	4	4	●	1
D0120T0030L12	1.2	30'	1.41	12	50	4	4	●	1
D0120T0030L16	1.2	30'	1.48	16	55	4	4	●	1
D0120T0100L06	1.2	1°	1.41	6	45	4	4	●	1
D0120T0100L10	1.2	1°	1.55	10	45	4	4	●	1
D0120T0100L12	1.2	1°	1.62	12	50	4	4	●	1
D0120T0100L16	1.2	1°	1.76	16	55	4	4	●	1
D0120T0100L20	1.2	1°	1.9	20	55	4	4	●	1
D0120T0130L06	1.2	1° 30'	1.51	6	45	4	4	●	1
D0120T0130L10	1.2	1° 30'	1.72	10	45	4	4	●	1
D0120T0130L12	1.2	1° 30'	1.83	12	50	4	4	●	1
D0120T0130L16	1.2	1° 30'	2.04	16	55	4	4	●	1
D0120T0130L20	1.2	1° 30'	2.25	20	55	4	4	●	1
D0120T0200L06	1.2	2°	1.62	6	45	4	4	●	1
D0120T0200L10	1.2	2°	1.9	10	45	4	4	●	1
D0120T0200L12	1.2	2°	2.04	12	50	4	4	●	1
D0120T0200L16	1.2	2°	2.32	16	55	4	4	●	1
D0120T0200L20	1.2	2°	2.6	20	55	4	4	●	1
D0130T0030L12	1.3	30'	1.51	12	50	4	4	●	1
D0130T0100L12	1.3	1°	1.72	12	50	4	4	●	1
D0130T0130L12	1.3	1° 30'	1.93	12	50	4	4	●	1
D0130T0200L12	1.3	2°	2.14	12	50	4	4	●	1
D0140T0030L12	1.4	30'	1.61	12	50	4	4	●	1
D0140T0100L12	1.4	1°	1.82	12	50	4	4	●	1
D0140T0130L12	1.4	1° 30'	2.03	12	50	4	4	●	1
D0140T0200L12	1.4	2°	2.24	12	50	4	4	●	1
D0150T0015L06	1.5	15'	1.55	6	45	4	4	●	1
D0150T0015L08	1.5	15'	1.57	8	45	4	4	●	1
D0150T0015L10	1.5	15'	1.59	10	45	4	4	●	1
D0150T0015L12	1.5	15'	1.6	12	50	4	4	●	1
D0150T0015L16	1.5	15'	1.64	16	55	4	4	●	1
D0150T0015L20	1.5	15'	1.67	20	55	4	4	●	1
D0150T0030L06	1.5	30'	1.6	6	45	4	4	●	1
D0150T0030L08	1.5	30'	1.64	8	45	4	4	●	1
D0150T0030L10	1.5	30'	1.67	10	45	4	4	●	1
D0150T0030L12	1.5	30'	1.71	12	50	4	4	●	1

MSTAR END MILLS

MS4LT

4 flute Mstar for rib processing taper neck end mill



$D_1 < 0.5$ 0 - -0.02
 $0.5 \leq D_1$ 0 - -0.04



±5'

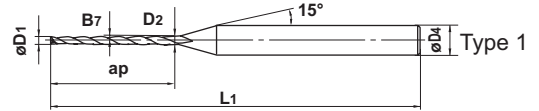

$D_1 < 3$

$3 \leq D_1$

- 4 flute Mstar for rib processing taper neck end mill for general purpose.

Unit : mm

Order Number	Small Mill Dia. D1	Taper Angle on Side B7	Large Mill Dia. D2	Length of Cut ap	Overall Length L1	Shank Dia. D4	No. of Flute N	Stock	Type
MS4LTD0150T0030L16	1.5	30'	1.78	16	55	4	4	●	1
D0150T0030L20	1.5	30'	1.85	20	55	4	4	●	1
D0150T0100L06	1.5	1°	1.71	6	45	4	4	●	1
D0150T0100L08	1.5	1°	1.78	8	45	4	4	●	1
D0150T0100L10	1.5	1°	1.85	10	45	4	4	●	1
D0150T0100L12	1.5	1°	1.92	12	50	4	4	●	1
D0150T0100L16	1.5	1°	2.06	16	55	4	4	●	1
D0150T0100L20	1.5	1°	2.2	20	55	4	4	●	1
D0150T0100L25	1.5	1°	2.37	25	60	4	4	●	1
D0150T0130L06	1.5	1° 30'	1.81	6	45	4	4	●	1
D0150T0130L08	1.5	1° 30'	1.92	8	45	4	4	●	1
D0150T0130L10	1.5	1° 30'	2.02	10	45	4	4	●	1
D0150T0130L12	1.5	1° 30'	2.13	12	50	4	4	●	1
D0150T0130L16	1.5	1° 30'	2.34	16	55	4	4	●	1
D0150T0130L20	1.5	1° 30'	2.55	20	55	4	4	●	1
D0150T0130L25	1.5	1° 30'	2.81	25	60	4	4	●	1
D0150T0200L06	1.5	2°	1.92	6	45	4	4	●	1
D0150T0200L08	1.5	2°	2.06	8	45	4	4	●	1
D0150T0200L10	1.5	2°	2.2	10	45	4	4	●	1
D0150T0200L12	1.5	2°	2.34	12	50	4	4	●	1
D0150T0200L16	1.5	2°	2.62	16	55	4	4	●	1
D0150T0200L20	1.5	2°	2.9	20	55	4	4	●	1
D0150T0200L25	1.5	2°	3.25	25	60	4	4	●	1
D0160T0030L08	1.6	30'	1.74	8	45	4	4	●	1
D0160T0030L12	1.6	30'	1.81	12	50	4	4	●	1
D0160T0030L16	1.6	30'	1.88	16	55	4	4	●	1
D0160T0030L20	1.6	30'	1.95	20	55	4	4	●	1
D0160T0100L08	1.6	1°	1.88	8	45	4	4	●	1
D0160T0100L12	1.6	1°	2.02	12	50	4	4	●	1
D0160T0100L16	1.6	1°	2.16	16	55	4	4	●	1
D0160T0100L20	1.6	1°	2.3	20	55	4	4	●	1
D0160T0130L08	1.6	1° 30'	2.02	8	45	4	4	●	1
D0160T0130L12	1.6	1° 30'	2.23	12	50	4	4	●	1
D0160T0130L16	1.6	1° 30'	2.44	16	55	4	4	●	1
D0160T0130L20	1.6	1° 30'	2.65	20	55	4	4	●	1
D0160T0200L08	1.6	2°	2.16	8	45	4	4	●	1
D0160T0200L12	1.6	2°	2.44	12	50	4	4	●	1
D0160T0200L16	1.6	2°	2.72	16	55	4	4	●	1

Unit : mm

Order Number	Small Mill Dia. D1	Taper Angle on Side B7	Large Mill Dia. D2	Length of Cut ap	Overall Length L1	Shank Dia. D4	No. of Flute N	Stock	Type
MS4LTD0160T0200L20	1.6	2°	3	20	55	4	4	●	1
D0180T0015L08	1.8	15'	1.87	8	45	4	4	●	1
D0180T0015L16	1.8	15'	1.94	16	55	4	4	●	1
D0180T0015L24	1.8	15'	2.01	24	60	4	4	●	1
D0180T0030L08	1.8	30'	1.94	8	45	4	4	●	1
D0180T0030L16	1.8	30'	2.08	16	55	4	4	●	1
D0180T0030L24	1.8	30'	2.22	24	60	4	4	●	1
D0180T0100L08	1.8	1°	2.08	8	45	4	4	●	1
D0180T0100L16	1.8	1°	2.36	16	55	4	4	●	1
D0180T0100L24	1.8	1°	2.64	24	60	4	4	●	1
D0180T0130L08	1.8	1° 30'	2.22	8	45	4	4	●	1
D0180T0130L16	1.8	1° 30'	2.64	16	55	4	4	●	1
D0180T0130L24	1.8	1° 30'	3.06	24	60	4	4	●	1
D0180T0200L08	1.8	2°	2.36	8	45	4	4	●	1
D0180T0200L16	1.8	2°	2.92	16	55	4	4	●	1
D0180T0200L24	1.8	2°	3.48	24	60	4	4	●	1
D0200T0015L08	2	15'	2.07	8	45	4	4	●	1
D0200T0015L10	2	15'	2.09	10	45	4	4	●	1
D0200T0015L12	2	15'	2.1	12	50	4	4	●	1
D0200T0015L16	2	15'	2.14	16	55	4	4	●	1
D0200T0015L20	2	15'	2.17	20	55	4	4	●	1
D0200T0015L25	2	15'	2.22	25	60	4	4	●	1
D0200T0030L08	2	30'	2.14	8	45	4	4	●	1
D0200T0030L10	2	30'	2.17	10	45	4	4	●	1
D0200T0030L12	2	30'	2.21	12	50	4	4	●	1
D0200T0030L16	2	30'	2.28	16	55	4	4	●	1
D0200T0030L20	2	30'	2.35	20	55	4	4	●	1
D0200T0030L25	2	30'	2.44	25	60	4	4	●	1
D0200T0030L30	2	30'	2.52	30	65	4	4	●	1
D0200T0100L08	2	1°	2.28	8	45	4	4	●	1
D0200T0100L10	2	1°	2.35	10	45	4	4	●	1
D0200T0100L12	2	1°	2.42	12	50	4	4	●	1
D0200T0100L16	2	1°	2.56	16	55	4	4	●	1
D0200T0100L20	2	1°	2.7	20	55	4	4	●	1
D0200T0100L25	2	1°	2.87	25	60	4	4	●	1
D0200T0100L30	2	1°	3.05	30	65	4	4	●	1
D0200T0130L08	2	1° 30'	2.42	8	45	4	4	●	1
D0200T0130L10	2	1° 30'	2.52	10	45	4	4	●	1
D0200T0130L12	2	1° 30'	2.63	12	50	4	4	●	1
D0200T0130L16	2	1° 30'	2.84	16	55	4	4	●	1
D0200T0130L20	2	1° 30'	3.05	20	55	4	4	●	1
D0200T0130L25	2	1° 30'	3.31	25	60	4	4	●	1
D0200T0130L30	2	1° 30'	3.57	30	65	4	4	●	1
D0200T0200L08	2	2°	2.56	8	45	4	4	●	1
D0200T0200L10	2	2°	2.7	10	45	4	4	●	1
D0200T0200L12	2	2°	2.84	12	50	4	4	●	1
D0200T0200L16	2	2°	3.12	16	55	4	4	●	1
D0200T0200L20	2	2°	3.4	20	55	4	4	●	1

MSTAR END MILLS

MS4LT

4 flute Mstar for rib processing taper neck end mill



$D_1 < 0.5$ 0 - -0.02
 $0.5 \leq D_1$ 0 - -0.04



±5'

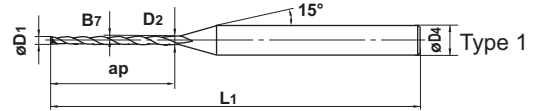

$D_1 < 3$

$3 \leq D_1$

● 4 flute Mstar for rib processing taper neck end mill for general purpose.

Unit : mm

Order Number	Small Mill Dia. D1	Taper Angle on Side B7	Large Mill Dia. D2	Length of Cut ap	Overall Length L1	Shank Dia. D4	No. of Flute N	Stock	Type
MS4LTD0200T0200L25	2	2°	3.75	25	60	4	4	●	1
D0200T0200L30	2	2°	4.1	30	65	6	4	●	1
D0200T0300L12	2	3°	3.26	12	50	4	4	●	1
D0200T0300L16	2	3°	3.68	16	55	4	4	●	1
D0200T0300L20	2	3°	4.1	20	55	6	4	●	1
D0200T0300L25	2	3°	4.62	25	60	6	4	●	1
D0200T0300L30	2	3°	5.14	30	65	6	4	●	1
D0250T0030L10	2.5	30'	2.67	10	45	4	4	●	1
D0250T0030L16	2.5	30'	2.78	16	50	4	4	●	1
D0250T0030L20	2.5	30'	2.85	20	55	4	4	●	1
D0250T0030L25	2.5	30'	2.94	25	60	4	4	●	1
D0250T0030L30	2.5	30'	3.02	30	65	4	4	●	1
D0250T0100L10	2.5	1°	2.85	10	45	4	4	●	1
D0250T0100L16	2.5	1°	3.06	16	50	4	4	●	1
D0250T0100L20	2.5	1°	3.2	20	55	4	4	●	1
D0250T0100L25	2.5	1°	3.37	25	60	4	4	●	1
D0250T0100L30	2.5	1°	3.55	30	65	4	4	●	1
D0250T0130L10	2.5	1° 30'	3.02	10	45	4	4	●	1
D0250T0130L16	2.5	1° 30'	3.34	16	50	4	4	●	1
D0250T0130L20	2.5	1° 30'	3.55	20	55	4	4	●	1
D0250T0130L25	2.5	1° 30'	3.81	25	60	4	4	●	1
D0250T0130L30	2.5	1° 30'	4.07	30	65	6	4	●	1
D0250T0200L10	2.5	2°	3.2	10	45	4	4	●	1
D0250T0200L16	2.5	2°	3.62	16	50	4	4	●	1
D0250T0200L20	2.5	2°	3.9	20	55	4	4	●	1
D0250T0200L25	2.5	2°	4.25	25	60	6	4	●	1
D0250T0200L30	2.5	2°	4.6	30	65	6	4	●	1
D0300T0030L25	3	30'	3.44	25	65	6	4	●	1
D0300T0030L40	3	30'	3.7	40	80	6	4	●	1
D0300T0100L25	3	1°	3.87	25	65	6	4	●	1
D0300T0100L40	3	1°	4.4	40	80	6	4	●	1
D0300T0130L25	3	1° 30'	4.31	25	65	6	4	●	1
D0300T0130L40	3	1° 30'	5.09	40	80	6	4	●	1
D0300T0200L25	3	2°	4.75	25	65	6	4	●	1
D0300T0200L40	3	2°	5.79	40	80	6	4	●	1

MS2XL

2 flute Mstar long neck end mill

Work material		Structural steel, Carbon steel, AISI 1049, AISI 1055 Alloy steel SCM, Tool steel SK, Pre-hardened steel, NAK, HPM			Pre-hardened steel AISI H13, STAVAX, Martensitic SUS (40–45HRC)		
Dia. (mm)	Neck length (mm)	Revolution (min ⁻¹)	Feed rate (mm/min)	Cutting depth a time (ap)	Revolution (min ⁻¹)	Feed rate (mm/min)	Cutting depth a time (ap)
0.2	0.5	40,000	200–400	0.01	30,000	150–400	0.01
	1.5			0.002			0.002
0.3	1	32,000–40,000	200–600	0.01	22,000–30,000	150–500	0.01
	3			0.002			0.002
	9			0.001			0.001
0.4	2	25,000–40,000	200–800	0.01	17,000–30,000	150–600	0.01
	4			0.003			0.003
	12			0.001			0.001
0.5	2	20,000–40,000	250–1,000	0.015	14,000–30,000	150–800	0.015
	6			0.005			0.005
	10			0.002			0.002
	15			0.001			0.001
0.6	2	17,000–33,000	250–1,000	0.02	12,000–25,000	150–800	0.02
	6			0.01			0.01
	10			0.003			0.003
	18			0.001			0.001
0.7	2	15,000–29,000	250–1,000	0.02	11,000–22,000	150–800	0.02
	6			0.01			0.01
	10			0.005			0.005
0.8	4	13,000–25,000	250–1,000	0.03	10,000–20,000	150–800	0.03
	8			0.02			0.02
	12			0.003			0.003
	24			0.001			0.001
0.9	6	11,000–22,000	250–1,000	0.04	9,000–18,000	150–800	0.04
	10			0.03			0.03
	15			0.003			0.003
1	4	10,000–20,000	250–1,000	0.06	8,000–16,000	150–800	0.06
	8			0.04			0.04
	12			0.02			0.02
	20			0.003			0.003
1.2	30	8,000–16,000	250–1,000	0.001	6,500–13,000	150–800	0.001
	6			0.08			0.08
	12			0.03			0.03
1.5	20	6,500–13,000	250–1,000	0.005	5,000–10,000	150–800	0.005
	6			0.12			0.12
	12			0.07			0.07
	30			0.01			0.01
2	45	5,000–10,000	250–1,000	0.002	4,200–8,500	150–800	0.002
	6			0.18			0.18
	12			0.12			0.12
	20			0.05			0.05
2.5	30	4,500–9,000	250–1,000	0.01	4,000–8,000	150–800	0.01
	40			0.003			0.003
	60			0.001			0.001
	8			0.25			0.25
	16			0.15			0.15
3	25	4,300–8,500	250–1,000	0.04	3,700–7,500	150–800	0.04
	40			0.01			0.01
	50			0.005			0.005
	8			0.3			0.3
	16			0.2			0.2
4	25	3,200–6,400	200–750	0.1	2,800–5,600	150–600	0.1
	40			0.02			0.02
	50			0.012			0.012
	12			0.8			0.8
	20			0.25			0.25
5	30	2,600–5,100	200–600	0.15	2,200–4,500	150–500	0.15
	45			0.05			0.05
	60			0.018			0.018
6	16	2,100–4,200	200–500	1	1,900–3,700	150–400	1
	35			0.2			0.2
	60			0.05			0.05
	20			1.2			1.2
	40			0.25			0.25
	60			0.1			0.1

- 1) The above table shows the revolution and feed rate for each neck length. Please reduce the revolution and feed rate when using end mills with longer neck length.
- 2) If the rigidity of the machine or the work material installation is very low, or chattering is generated, please reduce the revolution and the feed rate proportionately. Please reduce the feed rate when precision of the material surface is important.

Work material		Carbon steel, Alloy steel, Tool steel, Pre-hardened steel AISI 1049, SCM, SK, AISI H13, STAVAX, Martensitic SUS, NAK, HPM (-45HRC)			Hardened steel AISI H13 (45-52HRC)		
Small mill dia. (mm)	Length of cut (mm)	Revolution (min ⁻¹)	Feed rate (mm/min)	Cutting depth a time (ap)	Revolution (min ⁻¹)	Feed rate (mm/min)	Cutting depth a time (ap)
0.2	2	20,000-40,000	200-500	0.001	20,000-40,000	150-300	0.001
0.3	3	20,000-40,000	200-500	0.002	20,000-40,000	150-300	0.001
0.4	4	20,000-40,000	200-500	0.003	20,000-36,000	150-300	0.002
0.5	4	20,000-38,000	200-500	0.01	16,000-29,000	200-400	0.005
	6			0.005			0.003
0.6	4	18,000-32,000	250-600	0.01	13,000-24,000	200-400	0.005
	6			0.007			0.004
0.7	6	16,000-27,000	250-600	0.015	11,000-20,000	200-400	0.008
	8			0.01			0.005
0.8	4	14,000-24,000	250-600	0.03	10,000-18,000	200-400	0.015
	8			0.02			0.01
	12			0.013			0.007
1.0	6	11,000-19,000	300-800	0.03	8,000-14,000	200-500	0.015
	10			0.02			0.01
	16			0.015			0.008
1.2	6	9,200-16,000	300-800	0.04	6,600-12,000	200-500	0.02
	10			0.03			0.015
	16			0.02			0.01
1.3	12	8,500-15,000	300-800	0.03	6,100-11,000	200-500	0.015
1.4	12	8,000-14,000	300-800	0.035	5,700-10,000	200-500	0.018
1.5	6	7,500-13,000	300-800	0.06	5,300-9,500	200-500	0.03
	10			0.04			0.02
	16			0.03			0.015
	25			0.015			0.008
1.6	8	7,000-12,000	300-800	0.06	5,000-9,000	200-500	0.03
	12			0.045			0.025
	16			0.035			0.02
	20			0.025			0.015
1.8	8	6,200-11,000	300-800	0.08	4,400-8,000	200-500	0.04
	16			0.05			0.03
	24			0.03			0.015
2.0	8	5,500-9,500	300-800	0.1	4,000-7,200	200-500	0.05
	12			0.07			0.04
	20			0.04			0.02
	30			0.02			0.01
2.5	10	4,400-7,600	300-800	0.1	3,200-5,700	200-500	0.05
	20			0.06			0.03
	30			0.03			0.015
3.0	25	3,700-6,400	300-800	0.08	2,700-4,800	200-500	0.04
	40			0.04			0.02

- 1) The above table shows the revolution and feed rate for each neck length. Please reduce the feed rate when using end mills with longer neck length.
- 2) If the rigidity of the machine or the work material installation is very low, or chattering is generated, please reduce the revolution and the feed rate proportionately. Please reduce the feed rate when precision of the material surface is important.

SUGGESTIONS ON HOW TO USE CUTTING TOOLS

Products	Hazard	Countermeasure
All Cutting Tools	◎Cutting tools have sharp cutting edges Handling them with bare hands may cause injuries.	*Take precautions such as wearing gloves especially when handling tools and during installation.
	◎Improper use of tools and application of inappropriate cutting conditions may cause the tool to break and be expelled from the machine providing risk of injury.	*Ensure safety guards and goggles are used. Refer to handling explanatory notes and catalogues. Use tools under recommended cutting conditions.
	◎Impact load and rapid increase of cutting resistance due to excessive wear may cause the tool to break and be expelled from the machine providing risk of injury.	*Ensure safety guards and goggles are used. Exchange tools before excessive wear occurs.
	◎Cutting tools and workpieces become extremely hot during cutting. Touching them with bare hands may cause burns.	*Take precautions such as wearing gloves.
	◎Expelled hot chips produced in cutting produces risk of injuries and burns.	*Ensure safety guards and goggles are used. *During swarf removal and machine cleaning ensure the machine is stopped and wear gloves. Use tools, such as cutting nippers and cutting clippers.
	◎In cutting, sparks, hot chips and heat generation caused by tool breakage provides a risk of igniting a fire.	*Avoid using cutting tools in places where there is a possibility of igniting a fire. In case of using non-water soluble oil, make sure to have a fire prevention countermeasure.
	◎Using machines, chucks, and tools with poor balance at high revolutions may cause tools to break providing risk of injuries.	*Ensure safety guards and goggles are used. Check the machine for vibration, chattering, and abnormal noise.
	◎Handling machined parts with burrs using bare hands may cause injuries.	*Wear gloves.
Indexable Inserts	◎If inserts and spare parts are not held securely, they may become loose and be expelled producing risk of injuries.	*Clean insert locating seat and spare parts before setting inserts. *Use the tool provided for setting inserts, and ensure the inserts and spare parts are clamped securely. Do not use the tool provided for things other than prescribed inserts and spare parts.
	◎Clamping inserts and spare parts too tightly by using tools such as extension pipes may cause them to break and be expelled.	*Do not use extra tools for more leverage. Only use the tool provided.
	◎When applying high cutting speed, spare parts and inserts may be expelled due to centrifugal force. Pay special attention on each safety guideline.	*Refer to the handling explanatory notes and catalogues. Use tools under recommended cutting conditions.
Cutters and Other Rotating Tools	◎Milling cutters have sharp edges. Handling them with bare hands may cause injuries.	*Take precautions such as wearing gloves.
	◎Poor balance or off centre revolving of tools may cause vibration and chattering which could cause the tool to break and be expelled.	*Apply cutting speed within the range of recommended cutting conditions. *Adjust accuracy and balance of spindles and bearings periodically to prevent off centre revolving and chattering caused by wear on these parts.
Drills	◎Through cutting in cases when the workpiece revolves may produce a disk shaped peice with sharp edges when the cutting tool breaks through.	*Ensure safety guards and goggles are used. Also install a cover on the chuck.
	◎Drills with an extremely small diameter have a very sharp point which may puncture the skin if not handled carefully. If the drill breaks during cutting, the broken pieces may be expelled.	*Handle with care. Take precautions such as wearing gloves and goggles.
Brazed Tools	◎When brazing is carried out time and again, the strength of carbide tip is deteriorated and is easily broken during operation.	*Before using them, ensure they are brazed securely. *Do not use them under conditions which produce very high temperature.
Others	◎Machine and tools may be damaged if they are used for purposes other than the prescribed application.	*Use them strictly for the prescribed application.

INFORMATION

This catalog completes the basic precautions for safety use of our company's products. For further information, please refer to the guideline, catalogs or contact us. We are not responsible for any accidents causing by modifying tools without our permission.

MITSUBISHI MATERIALS KOBE TOOLSISO 9001
ISO 14001
JQA-2522
JQA-EM0941**MITSUBISHI MATERIALS CORPORATION
MARKETING DEPT.**KFC bldg., 8F, 1-6-1, Yokoami, Sumida-ku, Tokyo 130-0015, Japan
TEL 81-3-5819-8772 FAX 81-3-5819-8774**MMC HARTMETALL GmbH**Comeniusstr.2, 40670, Meerbusch GERMANY
TEL 49-2159-9189-0 FAX 49-2159-50462**MITSUBISHI MATERIALS U.S.A. CORPORATION
Headquarters**17401, Eastman Street, Irvine, California, 92614, USA
TEL 1-949-862-5100 FAX 1-949-862-5180**MMC METAL SINGAPORE PTE LTD.**10, Arumugam Road, #04-00 Lion Industrial Bldg., 409957, SINGAPORE
TEL 65-6743-9370 FAX 65-6749-1469